

RECEIVED-FPSC



00 JAN 20 PM 4:42

BellSouth Telecommunications, Inc  
Suite 400  
150 South Monroe Street  
Tallahassee, Florida 32301-1556

850 224-7798  
Fax 850 224-5073

Marshall M. Criser III  
Regulatory Vice President

RECORDS AND  
REPORTING

January 20, 2000

Mrs. Blanca S. Bayo  
Director, Division of Records and Reporting  
Florida Public Service Commission  
2540 Shumard Oak Boulevard  
Tallahassee, Florida 32399

000060-TP

Re: Approval of the Interconnection Agreement Adoption Negotiated by BellSouth Telecommunications, Inc. ("BellSouth") and YourTel Telecom Corporation pursuant to Sections 251, 252 and 271 of the Telecommunications Act of 1996

Dear Mrs. Bayo:

Pursuant to section 252(e) of the Telecommunications Act of 1996, BellSouth and YourTel Telecom Corporation are submitting to the Florida Public Service Commission their agreement (adoption) for the interconnection of their networks, the unbundling of specific network elements offered by BellSouth and the resale of BellSouth telecommunications services to YourTel Telecom Corporation. The agreement was negotiated pursuant to sections 251, 252 and 271 of the Act.

Pursuant to section 252(e) of the Act, the Commission is charged with approving or rejecting the agreement adoption between BellSouth and YourTel Telecom Corporation within 90 days of its submission. The Commission may only reject such an agreement if it finds that the agreement or any portion of the agreement discriminates against a telecommunications carrier not a party to the agreement or the implementation of the agreement or any portion of the agreement is not consistent with the public interest, convenience and necessity. Both parties represent that neither of these reasons exists as to the agreement they have negotiated and that the Commission should approve their agreement.

Very truly yours,

*Marshall M. Criser III*

Regulatory Vice President

(22) RECEIVED & FILED

DOCUMENT NUMBER-DATE  
FPSC-BUREAU OF RECORDS  
00507 JAN 20 8

## ATTACHMENT TO TRANSMITTAL LETTER

The Amendment entered into by and between YourTel Telecom Corporation, ("YourTel"), and BellSouth Telecommunications, Inc., dated 12/23/1999, for the state of Florida consists of the following:

ITEM	NO. PAGES
Adoption Papers	4
General Terms and Conditions – Part A	25
General Terms and Conditions – Part B	12
Attachment 1	10
Attachment 2	15
Attachment 3	107
Attachment 4	13
Attachment 5	9
Attachment 6	41
Attachment 7	10
Attachment 8	101
Attachment 9	4
Attachment 10	1
Amendment 1	5
Amendment 2	6
Amendment3	1
<b>TOTAL</b>	<b>364</b>

## AGREEMENT

This Agreement, which shall become effective as of the 23rd day of December, 1999, is entered into by and between YourTel Telecom Corporation, ("YourTel") a corporation on behalf of itself, and BellSouth Telecommunications, Inc., ("BellSouth"), a Georgia corporation, having an office at 675 W. Peachtree Street, Atlanta, Georgia, 30375, on behalf of itself and its successors and assigns.

**WHEREAS**, the Telecommunications Act of 1996 (the "Act") was signed into law on February 8, 1996; and

**WHEREAS**, section 252(i) of the Act requires BellSouth to make available any interconnection, service, or network element provided under an agreement approved by the appropriate state regulatory body to any other requesting telecommunications carrier upon the same terms and conditions as those provided in the agreement in its entirety; and

**WHEREAS**, YourTel has requested that BellSouth make available the interconnection agreement in its entirety executed between BellSouth and MCImetro Access Transmission Services, Inc. ("MCI") dated June 19, 1997 for the state of Florida

**NOW, THEREFORE**, in consideration of the promises and mutual covenants of this Agreement, YourTel and BellSouth hereby agree as follows:

1. YourTel and BellSouth shall adopt in its entirety the MCI Interconnection Agreement dated June 19, 1997 and any and all amendments to said agreement executed and approved by the appropriate state regulatory commission as of the date of the execution of this Agreement. The MCI Interconnection Agreement and all amendments are attached hereto as Exhibit 1 and incorporated herein by this reference. The adoption of this agreement with amendment(s) consists of the following:

ITEM	NO. PAGES
Adoption Papers	3
General Terms and Conditions – Part A	25
General Terms and Conditions – Part B	12
Attachment 1	10
Attachment 2	15
Attachment 3	105
Attachment 4	12

Attachment 4	12
Attachment 5	9
Attachment 6	39
Attachment 7	10
Attachment 8	99
Attachment 9	4
Attachment 10	1
Amendment 1	5
Amendment 2	5
Amendment 3	1
TOTAL	355

2. In the event that YourTel consists of two (2) or more separate entities as set forth in the preamble to this Agreement, all such entities shall be jointly and severally liable for the obligations of YourTel under this Agreement.

3. The term of this Agreement shall be from the effective date as set forth above and shall expire as set forth in Part A, Section 3 of the MCI Interconnection Agreement. For the purposes of determining the expiration date of this Agreement pursuant to Part A, Section 3 of the MCI Interconnection Agreement, the effective date shall be June 19, 1997.

4. YourTel and BellSouth shall accept and incorporate any amendments to the MCI Interconnection Agreement executed as a result of any final judicial, regulatory, or legislative action.

5. Every notice, consent, approval, or other communications required or contemplated by this Agreement shall be in writing and shall be delivered in person or given by postage prepaid mail, address to:

BellSouth Telecommunications, Inc.

CLEC Account Team  
 9th Floor  
 600 North 19<sup>th</sup> Street  
 Birmingham, Alabama 35203  
 and

General Attorney - COU  
Suite 4300  
675 W. Peachtree St.  
Atlanta, GA 30375

YourTel Telecom Corporation

Mr. Kevin McGilly  
Vice President-Regulatory Affairs  
7945 MacArthur Boulevard  
Suite 214  
Cabin John, MD 20818  
Facsimile: (301) 229-7730

and

Jeremy D. Marcus  
Blumenfeld & Cohen  
1625 Massachusetts Ave. NW  
Suite 300  
Washington DC 20036

or at such other address as the intended recipient previously shall have designated by written notice to the other Party. Where specifically required, notices shall be by certified or registered mail. Unless otherwise provided in this Agreement, notice by mail shall be effective on the date it is officially recorded as delivered by return receipt or equivalent, and in the absence of such record of delivery, it shall be presumed to have been delivered the fifth day, or next business day after the fifth day, after it was deposited in the mails.

IN WITNESS WHEREOF, the Parties have executed this Agreement through their authorized representatives.

BellSouth Telecommunications, Inc.

YourTel Telecom Corporation

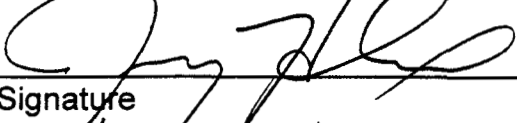
  
\_\_\_\_\_  
Signature

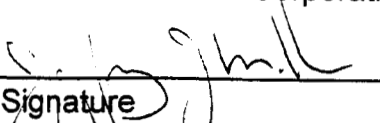
  
\_\_\_\_\_  
Signature

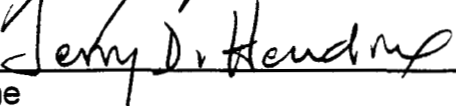
  
\_\_\_\_\_  
Name

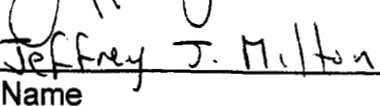
  
\_\_\_\_\_  
Name

  
\_\_\_\_\_  
Title

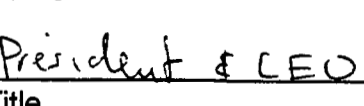
  
\_\_\_\_\_  
Title

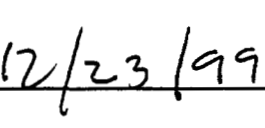
  
\_\_\_\_\_  
Date

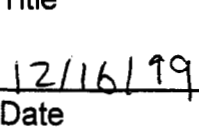
  
\_\_\_\_\_  
Date

MCImetro-BellSouth Florida Interconnection Agreement

**MCImetro/BellSouth INTERCONNECTION AGREEMENT**

This Interconnection Agreement (the "Agreement"), effective [insert date], 199\_\_ (the "Effective Date"), is entered into by and between BellSouth Telecommunications, Inc. ("BellSouth"), a Florida corporation, and MCImetro Access Transmission Services, Inc. ("MCIm"), a Delaware corporation, and to establish the rates, terms and conditions for interconnection, local resale, ancillary services and purchase of unbundled network elements (individually referred to as the "service" or collectively as the "services").

WHEREAS, the parties wish to interconnect their local exchange networks in a technically and economically efficient manner for the transmission and termination of calls ("Interconnection"); and

WHEREAS, MCIm wishes to purchase Telecommunications Services for resale to others ("Local Resale" or "Services for Resale"), and BellSouth is willing to provide such service pursuant to the terms and conditions of this Agreement; and

WHEREAS, MCIm wishes to purchase on an unbundled basis Network Elements, and BellSouth is willing to provide such services; and

WHEREAS, MCIm wishes to purchase ancillary services such as access to poles, ducts conduits and rights of way and collocation of equipment at BellSouth's facilities on the terms and subject to the conditions of this Agreement; and

WHEREAS, the parties intend the rates, terms and conditions of this Agreement, and their performance of obligations thereunder, to comply with the Communications Act of 1934, as amended by the Telecommunications Act of 1996 (the "Act"), the applicable Rules and Regulations of the Federal Communications Commission ("FCC") in effect, and the orders, rules and regulations of the state regulatory body.

Now, therefore, in consideration of the terms and conditions contained herein, BellSouth and MCIm hereby mutually agree as follows:

**PART A  
GENERAL TERMS AND CONDITIONS**

**Section 1. Scope of this Agreement**

1.1 This Agreement, including Parts A, B, and C, specifies the rights and obligations of each party with respect to the purchase and sale of Interconnection, Local Resale, Network Elements and ancillary services. This PART A sets forth the general terms and conditions governing this Agreement. Certain terms used in this Agreement shall have the meanings defined in PART B – DEFINITIONS, or as otherwise elsewhere defined throughout this Agreement. Other terms used but not defined herein will have the meanings ascribed to them in the Act and the applicable FCC Rules and Regulations in effect. PART C sets forth, among other things, descriptions of the services, pricing, technical and business requirements, and physical and network security requirements.

**LIST OF ATTACHMENTS COMPRISING PART C:**

- I. Price Schedule
- II. Local Resale
- III. Network Elements
- IV. Interconnection
- V. Collocation
- VI. Rights of Way
- VII. Number Portability
- VIII. Business Process Requirements
- IX. Security Requirements
- X. Credits for Performance Standards Failures

1.2 BellSouth shall provide the services pursuant to this Agreement. Except as provided below, BellSouth shall not discontinue or refuse to provide any service provided or required hereunder without MCIm's prior written agreement. Such agreement shall not be unreasonably withheld. BellSouth shall not discontinue any telecommunications service available for resale unless BellSouth provides MCIm prior written notice of its intent to discontinue any such service. BellSouth agrees to make any such service available to MCIm for resale to MCIm customers who are subscribers to such services from MCIm until the date BellSouth discontinues any such service for BellSouth's customers. BellSouth also agrees to adopt a reasonable, nondiscriminatory transition schedule for BellSouth and MCIm customers who may be purchasing any such service.

1.2.1 Left Blank Intentionally



1.2.2 Left Blank Intentionally

**Section 2. Regulatory Approvals**

2.1 This Agreement, and any amendment or modification hereof, will be submitted to the state regulatory body for approval in accordance with Section 252 of the Act. Should the state regulatory body deny approval of the Agreement or any part thereof, the parties agree to consider whether any additional and appropriate judicial or administrative efforts are necessary to gain approval of said part or Agreement. If it is mutually determined that the part or Agreement must be renegotiated to gain approval by the state regulatory body, the parties agree to do so on an expedited basis. If the parties fail to reach agreement, either party may seek resolution pursuant to Section 23 (Dispute Resolution Procedures) of this Agreement.

2.2 In the event the FCC or the State regulatory body promulgates rules or regulations, or issues orders, or a court with appropriate jurisdiction issues orders, which make unlawful any provision of this Agreement, the parties shall negotiate promptly and in good faith in order to amend the Agreement to substitute contract provisions which are consistent with such rules, regulations or orders. In the event the parties cannot agree on an amendment within thirty (30) days from the date any such rules, regulations or orders become effective, then the parties shall resolve their dispute under the applicable procedures set forth in Section 23 (Dispute Resolution Procedures) hereof.

2.3 In the event BellSouth is required by any governmental authority to file a tariff or make another similar filing ("Filing") in order to implement this Agreement, BellSouth shall (i) consult with MCIm reasonably in advance of such Filing about the form and substance of such Filing, (ii) provide to MCIm its proposed tariff and obtain MCIm's agreement on the form and substance of such Filing, and (iii) take all steps reasonably necessary to ensure that such Filing imposes obligations upon BellSouth that are no less favorable than those provided in this Agreement and preserves for MCIm the full benefit of the rights otherwise provided in this Agreement. In no event shall BellSouth file any tariff to implement this Agreement that purports to govern the services provided hereunder that is inconsistent with the rates and other terms and conditions set forth in this Agreement unless such rate or other terms and conditions are more favorable than those set forth in this Agreement.

2.4 In the event that any final and nonappealable legislative, regulatory, judicial or other legal action materially affects any material terms of this Agreement, or the ability of MCIm or BellSouth to perform any material terms of this Agreement, or in the event a judicial or administrative stay of such action is not sought or granted, MCIm or BellSouth may, on thirty (30) days written notice (delivered not later than thirty (30) days following the date on which such action has become

legally binding and has otherwise become final and nonappealable) require that such terms be renegotiated, and the Parties shall renegotiate in good faith such mutually acceptable new terms as may be required. In the event that such new terms are not renegotiated within ninety (90) days after such notice, the dispute shall be resolved in accordance with Section 23 (Dispute Resolution Procedures) of this Agreement.

2.5 The parties intend that any additional services requested by either party relating to the subject matter of this Agreement will be incorporated into this Agreement by amendment.

### ***Section 3. Term of Agreement***

This Agreement shall become binding upon execution by the parties and continue for a period of 3 years, unless earlier terminated in accordance with Section 20 (Termination). No later than 180 days prior to the expiration of this Agreement, the parties agree to commence negotiations with regard to the terms, conditions and prices of a follow on agreement for the provision of services to be effective on or before the expiration date of this Agreement ("Follow-on Agreement"). The Parties further agree that any such Follow-on Agreement shall be for a term of no less than three years unless the Parties agree otherwise.

If, within 135 days of commencing the negotiation referenced above, the Parties are unable to satisfactorily negotiate new terms, conditions and prices, either Party may petition the State regulatory body to establish an appropriate Follow-on Agreement pursuant to 47 U.S.C. '252. The Parties agree that in such event they shall encourage the State regulatory body to issue its order regarding such Follow-on Agreement no later than the expiration date of this Agreement. The Parties further agree that in the event the State regulatory body does not issue its order by the expiration date of this Agreement or if the Parties continue beyond the expiration date of this Agreement to negotiate without State regulatory body intervention, the terms, conditions and prices ultimately ordered by the State regulatory body, or negotiated by the Parties, will be effective retroactive to the day following the expiration date of this Agreement. Until the Follow-on Agreement becomes effective, BellSouth shall provide Services pursuant to the terms, conditions and prices of this Agreement that are then in effect.

### ***Section 4. Charges and Payment***

In consideration of the services provided by BellSouth under this Agreement, MCIm shall pay the charges set forth in Attachment I. The billing and payment procedures for charges incurred by MCIm hereunder are set forth in Attachment VIII.

**Section 5. Assignment and Subcontract**

5.1 Any assignment by either party to any non-affiliated entity of any right, obligation or duty, or of any other interest hereunder, in whole or in part, without the prior written consent of the other party shall be void. A party may assign this Agreement or any right, obligation, duty or other interest hereunder to an Affiliate company of the party without the consent of the other party. All obligations and duties of any party under this Agreement shall be binding on all successors in interest and assigns of such party. No assignment or delegation hereof shall relieve the assignor of its obligations under this Agreement in the event that the assignee fails to perform such obligations.

5.2 If any party's obligation under this Agreement is performed by a subcontractor or affiliate, the Party subcontracting the obligation nevertheless shall remain fully responsible for the performance of this Agreement in accordance with its terms, and shall be solely responsible for payments due its subcontractors or affiliates. No subcontractor or affiliate shall be deemed a third party beneficiary for any purposes under this Agreement.

**Section 6. Compliance with Laws**

All terms, conditions and operations under this Agreement shall be performed in accordance with all applicable laws, regulations and judicial or regulatory decisions of all duly constituted governmental authorities with appropriate jurisdiction, and this Agreement shall be implemented consistent with the applicable rules and regulations of the FCC and the state regulatory body in effect. Each party shall be responsible for obtaining and keeping in effect all FCC, state commission, franchise authority and other regulatory approvals that may be required in connection with the performance of its obligations under this Agreement. In the event the basis for this Agreement (e.g., the Act, FCC Rules and Regulations, orders of the state regulatory body) is held to be invalid or changed for any reason, this Agreement shall survive, and the parties shall promptly renegotiate any provisions of this Agreement, which in the absence of such invalidated or changed Act, Rule or Regulation are insufficiently clear to be effectuated.

**Section 7. Governing Law**

This Agreement shall be governed by and construed in accordance with applicable federal law and the laws of the state of Florida, without regard to its conflicts of laws principles.

**Section 8. Relationship of Parties**

Each party is an independent contractor, and has and hereby retains the right to exercise full control of and supervision over its own performance of its obligations under this Agreement and retains full control over the employment, direction, compensation and discharge of all employees assisting in the performance of such obligations.

***Section 9. No Third Party Beneficiaries***

The provisions of this Agreement are for the benefit of the parties hereto and not for any other person. This Agreement shall not provide any person not a party hereto with any remedy, claim, liability, reimbursement, claim of action, or other right in excess of those existing without reference hereto.

***Section 10. Intellectual Property Rights and Indemnification***

10.1 Any intellectual property which originates from or is developed by a party shall remain in the exclusive ownership of that party. Except for a limited license to use patents or copyrights to the extent necessary for the parties to use any facilities or equipment (including software) or to receive any service solely as provided under this Agreement, no license in patent, copyright, trademark or trade secret, or other proprietary or intellectual property right now or hereafter owned, controlled or licensable by a party, is granted to the other party or shall be implied or arise by estoppel. It is the responsibility of each party to ensure at no additional cost to the other party that it has obtained any necessary licenses in relation to intellectual property of third parties used in its network that may be required to enable the other party to use any facilities or equipment (including software), to receive any service, or to perform its respective obligations under this Agreement.

10.2 The party providing a service pursuant to this Agreement will defend the party receiving such service or data provided as a result of such service against claims of infringement arising solely from the use by the receiving party of such service and will indemnify the receiving party for any damages awarded based solely on such claims in accordance with Section 11 of this Agreement.

10.3 In the event that use of any facilities or equipment (including software), becomes or, in reasonable judgment of the party who owns the affected network is likely to become, the subject of a claim, action, suit, or proceeding based on intellectual property infringement, then said party shall promptly and at its sole expense, but subject to the limitations of liability set forth below:

- (i) modify or replace the applicable facilities or equipment (including software) while maintaining form and function, or (ii) obtain a license sufficient to allow such use to continue. In the event (i) or (ii) are commercially unreasonable, then said party may, (iii) terminate, upon

MCImetro-BellSouth Florida Interconnection Agreement

reasonable notice, this contract with respect to use of, or services provided through use of, the affected facilities or equipment (including software), but solely to the extent required to avoid the infringement claim.

10.4 Neither party's obligations under this Section shall apply to the extent the infringement is caused by: (i) modification of the facilities or equipment (including software) by the indemnitee; (ii) use by the indemnitee of the facilities or equipment (including software) in combination with equipment or facilities (including software) not provided or authorized by the indemnitor provided the facilities or equipment (including software) would not be infringing if used alone; (iii) conformance to specifications of the indemnitee which would necessarily result in infringement; or (iv) continued use by the indemnitee of the affected facilities or equipment (including software) after being placed on notice to discontinue use as set forth herein.

10.5 The foregoing shall constitute the parties' sole and exclusive remedies and obligations with respect to a third party claim of intellectual property infringement arising out of the conduct of business under this Agreement.

**Section 11 Indemnification and Limitation of Liability**

11.1..Left Blank Intentionally.

11.1.1 Left Blank Intentionally.

11.1.2 ..Left Blank Intentionally.

11.2 ..Left Blank Intentionally..

11.3 ..Left Blank Intentionally..

11.4 ..Left Blank Intentionally..

11.5 ..Left Blank Intentionally..

11.6 ..Left Blank Intentionally..

11.7 Both parties agree that they, at their own cost and expense, shall maintain throughout the term of this Agreement, all insurance required by law, and may at their own cost and expense purchase insurance or self-insure their employer, public, professional and legal liabilities. No limit of liability on any policy, no program or self-insurance, nor any failure to maintain adequate insurance coverage shall limit the direct or indirect liability of either party.

**Section 12. Left Blank Intentionally**

**Section 13. Continuing Obligations**

13.1 Except as otherwise provided herein, each party shall perform its obligations hereunder at a performance level no less than the level which it uses for its own operations, or those of its Affiliates, but in no event shall a party use less than reasonable care in the performance of its duties hereunder.

13.2 BellSouth agrees that Interconnection will be provided in a competitively neutral fashion, at any technically feasible point within its network as stated in this Agreement and that such interconnection will contain all the same features, functions and capabilities, and be at least equal in quality to the level provided by BellSouth to itself or its Affiliates.

13.3 BellSouth agrees that it will provide to MCIm on a nondiscriminatory basis unbundled Network Elements and ancillary services as set forth in this Agreement and the operations support systems as set forth in this Agreement. BellSouth further agrees that these services, or their functional components, will contain all the same features, functions and capabilities and be provided at a level of quality at least equal to the level which it provides to itself or its Affiliates.

13.4. BellSouth agrees that it will provide to MCIm nondiscriminatory access to, poles, ducts, conduits, and rights of way owned or controlled by BellSouth in accordance with the requirements of Section 224 of the Act.

13.5 BellSouth Agrees that it will provide nondiscriminatory access to telephone numbers for as long as BellSouth remains the code administrator for the North American Numbering Plan.

13.6 BellSouth agrees that it will provide to MCIm, in a competitively neutral fashion, interim number portability as set forth herein and in accordance with the applicable rules, regulations and orders of the FCC and this Commission, including the First Report and Order, released July 2, 1996 in CC Docket No. 95-116, regarding Telephone Number Portability, in effect.

13.7 BellSouth agrees that it will provide to MCIm, in a competitively neutral fashion, dialing parity for local exchange service and interexchange service pursuant to the applicable rules, regulations and orders of the state regulatory body and the FCC in effect.

13.8 BellSouth agrees that order entry, provisioning, installation, trouble resolution, maintenance, billing, and service quality with respect to Local Resale will be provided at least as expeditiously as BellSouth provides for itself or for its own retail local service or to others, or to its Affiliates, and that it will provide such services to MCIm in a competitively neutral fashion.

MCImetro-BellSouth Florida Interconnection Agreement

13.9 BellSouth agrees that it will provide on a nondiscriminatory basis space on its premises for physical or virtual collocation, as MCI may specify, for equipment necessary for MCI's interconnection and access to unbundled network elements.

**Section 14. Notices**

Except as otherwise provided herein, all notices or other communication hereunder shall be deemed to have been duly given when made in writing and delivered in person by overnight courier, or deposited in the United States mail, certified mail, postage prepaid, return receipt requested and addressed as follows:

To MCI: MCImetro Access Transmission Services, Inc.  
8521 Leesburg Pike  
Vienna, VA 22182

Copy to: General Counsel  
MCI Communications Corporation  
1801 Pennsylvania Ave, N.W.  
Washington, DC 20006

To BellSouth: Clifford H. Bowers  
BellSouth Telecommunications, Inc.  
1960 W. Exchange Pl., Ste. 402  
Tucker, GA 30084

Copy to: General Attorney-Interconnection  
BellSouth Telecommunications, Inc  
Suite 4300  
675 W. Peachtree Street, N.E.  
Atlanta, Georgia 30375

If personal delivery or courier is selected to give notice, a receipt of such delivery shall be obtained. The address to which notices or communications may be given to either party may be changed by written notice given by such party to the other pursuant to this Section 14.

**Section 15. Remedies**

15.1 The obligations of BellSouth and the services offered under this Agreement are unique. Accordingly, in addition to any other available rights or remedies, MCI may sue in equity for specific performance.

15.2 Left Blank Intentionally

15.3 All rights of termination, cancellation or other remedies prescribed in this Agreement, or otherwise available, are cumulative and are not intended to be exclusive of other remedies to which the injured party may be entitled at law or equity in case of any breach or threatened breach by the other party of any provision of this Agreement. Use of one or more remedies shall not bar use of any other remedy for the purpose of enforcing the provisions of this Agreement.

**Section 16. Waivers**

16.1 No waiver of any provisions of this Agreement and no consent to any default under this Agreement shall be effective unless the same shall be in writing and properly executed by or on behalf of the party against whom such waiver or consent is claimed.

16.2 No course of dealing or failure of any party to strictly enforce any term, right, or condition of this Agreement in any instance shall be construed as a general waiver or relinquishment of such term, right or condition.

16.3 Waiver by either party of any default by the other party shall not be deemed a waiver of any other default.

**Section 17. Survival**

The following provisions of this Part A shall survive the expiration or termination of this Agreement: Sections 10, 11, 12, 21, 22, 26 and 27, and any other obligations to be performed after the expiration or termination of the Agreement.

**Section 18. Force Majeure**

Neither party shall be held liable for any delay or failure in performance of any part of this Agreement from any cause beyond its control and without its fault or negligence, such as acts of God, acts of civil or military authority, embargoes, epidemics, war, terrorist acts, riots, insurrections, fires, explosions, earthquakes, strikes, nuclear accidents, floods, power blackouts, or unusually severe weather.

In the event of any such excused delay in the performance of a party's obligations(s) under this Agreement, the due date for the performance of the original obligation(s) shall be extended by a term equal to the time lost by reason of delay. In the event of such delay, the delaying party shall perform its obligations at a performance level no less than that which it uses for its own operations and will resume performance in a nondiscriminatory manner.

**Section 19. Non-Discriminatory Treatment**



If as a result of any proceeding or filing before any Court, State Commission, or the Federal Communications Commission, voluntary agreement or arbitration proceeding pursuant to the Act or pursuant to any applicable state law, BellSouth becomes obligated to provide Services and Elements, whether or not presently covered by this Agreement, to a third Party at rates or on terms and conditions more favorable to such third Party than the applicable provisions of this Agreement, MCIm shall have the option to substitute such more favorable rates, terms, and conditions for the relevant provisions of this Agreement which shall apply to the same States as such other Party, and such substituted rates, terms or conditions shall be deemed to have been effective under this Agreement as of the effective date thereof. BellSouth shall provide to MCIm any BellSouth agreement between BellSouth and any third Party within fifteen (15) days of the filing of such agreement with any state Commission.

## **Section 20. Termination**

20.1 In the event of breach of any material provision of this Agreement by either party, the non-breaching party shall give the other party written notice thereof, and:

20.1.1 If such material breach is for non-payment of amounts due hereunder pursuant to Attachment VIII, Section 3.1.18, the breaching party shall cure such breach within thirty (30) days of receiving such notice. The non-breaching party shall be entitled to pursue all available legal and equitable remedies for such breach. Amounts disputed in good faith and withheld or set off shall not be deemed "amounts due hereunder" for the purpose of this provision.

20.1.2 If such material breach is for any failure to perform in accordance with this Agreement, which adversely affects the non-breaching party's subscribers, the non-breaching party shall give notice of the breach and the breaching party shall cure such breach to the non-breaching party's reasonable satisfaction within ten (10) business days, and if breaching party does not, the non-breaching party may, at its sole option, terminate this Agreement, or any parts hereof. The non-breaching party shall be entitled to pursue all available legal and equitable remedies for such breach. Notice under this Subsection 20.1.2 may be given electronically or by facsimile and in such case shall be deemed received when sent.

20.1.3 If such material breach is for any other failure to perform in accordance with this Agreement, the breaching party shall cure such breach to the non-breaching party's reasonable satisfaction within forty-five (45) days, and if it does not, the non-breaching party may, at its sole option terminate this Agreement, or any parts hereof. The non-breaching party shall be entitled to pursue all available legal and equitable remedies

for such breach.

20.2 Left Blank Intentionally.

**Section 21. Confidentiality and Publicity**

21.1 All confidential or proprietary information disclosed by either party during the negotiations and the term of this Agreement shall be protected by the parties in accordance with the terms of this Section 21. All information which is disclosed by one party ("Disclosing Party") to the other ("Recipient") in connection with this Agreement, or acquired in the course of performance of this Agreement, shall be deemed confidential and proprietary to the Disclosing Party and subject to this Agreement, such information including but not limited to, orders for services, usage information in any form, and Customer Proprietary Network Information ("CPNI") as that term is defined by the Act and the rules and regulations of the FCC ("Confidential Information").

21.1.1 For a period of eight (8) years from receipt of Confidential Information, Recipient shall (i) use it only for the purpose of performing under this Agreement, (ii) hold it in confidence and disclose it only to employees who have a need to know it in order to perform under this Agreement, and (iii) safeguard it from unauthorized use of Disclosure using no less than the degree of care with which Recipient safeguards its own Confidential Information. If Recipient wishes to disclose the Discloser's Confidential Information to a third party agent or consultant in order to perform Recipient's obligations hereunder, such third party must have executed a written agreement comparable in scope to the terms of this Section 21.

21.1.2 Recipient shall have no obligation to safeguard Confidential Information (i) which was in the Recipient's possession free of restriction prior to its receipt from Disclosing Party, (ii) which becomes publicly known or available through no breach of this Agreement by Recipient, (iii) which is rightfully acquired by Recipient free of restrictions on its Disclosure, or (iv) which is independently developed by personnel of Recipient to whom the Disclosing Party's Confidential Information had not been previously disclosed. Recipient may disclose Confidential Information if required by law, a court, or governmental agency, provided that Disclosing Party has been notified of the requirement promptly after Recipient becomes aware of the requirement, and provided that Recipient undertakes all lawful measures to avoid disclosing such information until Disclosing Party has had reasonable time to obtain a protective order. Recipient agrees to comply with any protective order that covers the Confidential Information to be disclosed.

**MCImetro-BellSouth Florida Interconnection Agreement**

**21.1.3 Each party agrees that Disclosing Party would be irreparably injured by a breach of this Section 21 by Recipient or its representatives and that Disclosing Party shall be entitled to seek equitable relief, including injunctive relief and specific performance, in the event of any breach of this Section 21. Such remedies shall not be exclusive, but shall be in addition to all other remedies available at law or in equity.**

**21.2 CPNI related to MCIm's subscribers obtained by virtue of Local Interconnection or any other service provided under this Agreement shall be MCIm's proprietary information and may not be used by BellSouth for any purpose except performance of its obligations under this Agreement, and in connection with such performance, shall be disclosed only to employees with a need to know, unless the MCIm subscriber expressly directs MCIm to disclose such information to BellSouth pursuant to the requirements of Section 222(c)(2) of the Act. In the event such authorization is obtained, BellSouth may use or disclose only such information as MCIm provides pursuant to such authorization and may not use information that BellSouth has otherwise obtained, directly or indirectly, in connection with its performance under this Agreement. CPNI related to BellSouth's subscribers obtained by virtue of Local Interconnection shall be BellSouth's proprietary information and may not be used by MCIm for any purpose except performance of its obligations under this Agreement, and in connection with such performance shall be disclosed only to employees with a need to know, unless the BellSouth subscriber expressly directs BellSouth to disclose such information to MCIm pursuant to the requirements of Section 222(c)(2) of the Act. In the event such authorization is obtained, MCIm may use or disclose only such information as BellSouth provides pursuant to such authorization and may not use information that MCIm has otherwise obtained, directly or indirectly, in connection with its performance under this Agreement.**

**21.3 Unless otherwise mutually agreed upon, neither party shall publish or use the other party's logo, trademark, service mark, name, language, pictures, or symbols or words from which the other party's name may reasonably be inferred or implied in any product, service, advertisement, promotion, or any other publicity matter.**

**21.4 Neither party shall produce, publish or distribute any press release or other publicity referring to the other party or its Affiliates, or announcing the execution or discussing the terms of this Agreement without prior notice to the other party. In no event shall either party mischaracterize the contents of this Agreement in any public statement or in any representation to a governmental entity or member thereof.**

**21.5 Except as otherwise expressly provided in this Section 21, nothing herein shall be construed as limiting the rights of either party with respect to its customer information under any applicable law, including without limitation**

Section 222 of the Act.

**Section 22. Audits and Inspections**

22.1 The following audit procedures shall apply.

22.1.1 Subject to BellSouth's reasonable security requirements and except as may be otherwise specifically provided in this Agreement, MCIm may audit BellSouth's books, records and other documents once in each Contract Year for the purpose of evaluating the accuracy of BellSouth's billing and invoicing. MCIm may employ other persons or firms for this purpose. Such audit shall take place at a time and place agreed on by the Parties no later than thirty (30) days after notice thereof to BellSouth.

22.1.2 BellSouth shall promptly correct any billing error that is revealed in an audit, including making refund of any overpayment by MCIm in the form of a credit on the invoice for the first full billing cycle after the Parties have agreed upon the accuracy of the audit results. Any Disputes concerning audit results shall be resolved pursuant to the Dispute Resolution Procedures described in Section 23 of this Attachment.

22.1.3 BellSouth shall cooperate fully in any such audit, providing reasonable access to any and all appropriate BellSouth employees and books, records and other documents reasonably necessary to assess the accuracy of BellSouth's bills.

22.1.4 MCIm may audit BellSouth's books, records and documents more than once during any Contract Year if the previous audit found previously uncorrected net variances or errors in invoices in BellSouth's favor with an aggregate value of at least two percent (2%) of the amounts payable by MCIm for Services and Elements or Combinations provided during the period covered by the audit.

22.1.5 Audits shall be at MCIm's expense, subject to reimbursement by BellSouth in the event that an audit finds an adjustment in the charges or in any invoice paid or payable by MCIm hereunder by an amount that is, on an annualized basis, greater than two percent (2%) of the aggregate charges for the Services and Elements during the period covered by the audit.

22.1.6 Upon (i) the discovery by BellSouth of overcharges not previously reimbursed to MCIm or (ii) the resolution of disputed audits, BellSouth shall promptly reimburse MCIm the amount of any overpayment times the highest interest rate (in decimal value) which may be levied by law for

commercial transactions, compounded daily for the number of days from the date of overpayment to and including the date that payment is actually made. In no event, however, shall interest be assessed on any previously assessed or accrued late payment charges.

22.2 Subject to reasonable security requirements, either Party may audit the books, records and other documents of the other for the purpose of evaluating usage pertaining to transport and termination of local traffic. Where such usage data is being transmitted through CABS, the audit shall be conducted in accordance with CABS or other applicable requirements approved by the appropriate State Commission. If data is not being transferred via CABS, either Party may request an audit for such purpose once each Contract Year. Either Party may employ other persons or firms for this purpose. Any such audit shall take place no later than thirty (30) days after notice thereof to the other Party.

22.2.1 Either Party shall promptly correct any reported usage error that is revealed in an audit, including making payment of any underpayment after the Parties have agreed upon the accuracy of the audit results. Any Disputes concerning audit results shall be resolved pursuant to the Alternate Dispute Resolution procedures described in Section 16 of the General Terms and Conditions and Attachment 1.

22.2.2 The Parties shall cooperate fully in any such audit, providing reasonable access to any and all appropriate employees and books, records and other documents reasonably necessary to assess the usage pertaining to transport and terminating of local traffic.

22.3 This Section 22 shall survive expiration or termination of this Agreement shall for a period of two (2) years after expiration or termination of this Agreement.

### ***Section 23. Dispute Resolution Procedures***

The parties recognize and agree that the Commission has continuing jurisdiction to implement and enforce all terms and conditions of this Agreement. Accordingly, the parties agree that any dispute arising out of or relating to this Agreement that the parties themselves cannot resolve, may be submitted to the Commission for resolution. The parties agree to seek expedited resolution by the Commission, and shall request that resolution occur in no event later than sixty (60) days from the date of submission of such dispute. If the Commission appoints an expert(s) or other facilitator(s) to assist in its decision making, each party shall pay half of the fees and expenses so incurred. During the Commission proceeding each party shall continue to perform its obligations under this Agreement; provided, however that neither party shall be required to

act in any unlawful fashion. This provision shall not preclude the parties from seeking relief available in any other forum.

**Section 24. Bona Fide Request Process for Further Unbundling**

BellSouth shall, upon request of MCIm, and to the extent technically feasible, provide to MCIm access to its unbundled elements for the provision of MCIm's telecommunications service. Any request by MCIm for access to an unbundled element that is not already available shall be treated as an unbundled element Bona Fide Request. The parties shall adhere to the process as agreed and described in Exhibit 1.

**Section 25. Branding**

25.1 In all cases in which BellSouth has control over handling of services MCIm may provide using services provided by BellSouth under this Agreement, BellSouth shall brand any and all such services at all points of customer contact exclusively as MCIm services, or otherwise as MCIm may specify, or be provided with no brand at all, as MCIm shall determine. BellSouth may not unreasonably interfere with branding by MCIm. If for any reason, BellSouth finds that it is not possible to brand operator services and directory service calls for MCIm, BellSouth shall revert to generic unbranding for all local service providers, including itself.

25.2 MCIm shall provide the exclusive interface to MCIm subscribers, except as MCIm shall otherwise specify. In those instances where MCIm requires BellSouth personnel or systems to interface with MCIm subscribers, such BellSouth personnel shall identify themselves as representing MCIm, or such brand as MCIm may specify, and shall not identify themselves as representing BellSouth or any other entity, and shall refrain from marketing BellSouth, directly or indirectly, to MCIm subscribers.

25.3 BellSouth shall distribute to MCIm subscribers materials provided by MCIm. Such materials shall be prepared by MCIm and provided in sufficient quantities to BellSouth at MCIm's cost. All forms, business cards or other business materials furnished by BellSouth to MCIm subscribers shall be provided by MCIm unless otherwise agreed by MCIm, in its sole discretion, in which case, any such customer materials shall be subject to MCIm's prior review and approval, and shall bear no corporate name, logo, trademark or trade names other than MCIm or its Affiliates or such other brand as MCIm, in its sole discretion, shall determine. If, however, the technician does not have a company specific card available at the time services are performed, the BellSouth technician shall use a generic card. Neither BellSouth's vehicles nor its technicians shall be required to bear the MCIm logo.

MCImetro-BellSouth Florida Interconnection Agreement

25.4 Except as specifically permitted MCIm, in no event shall BellSouth provide information to MCIm subscribers about MCIm or MCIm's products or services.

25.5 BellSouth shall provide, for MCIm's review and approval, the methods and procedures, training and approaches to be used by BellSouth to assure that BellSouth meets MCIm's branding requirements.

25.6 This Section 25 shall not confer on either party rights to the service marks, trademarks and trade names owned by or used in connection with services by the other party or its Affiliates, except as expressly permitted by the other party.

25.7 Left Blank Intentionally

**Section 26. Taxes**

**26.1 Definition**

For purposes of this Section 26, the terms "taxes" and "fees" shall include but not be limited to federal, state or local sales, use, excise, gross receipts or other taxes or tax-like fees of whatever nature and however designated (including tariff surcharges and any fees, charges or other payments, contractual or otherwise, for the use of public streets or rights of way, whether designated as franchise fees or otherwise) imposed, or sought to be imposed, on either of the parties and measured by the charges or payments, for the services furnished hereunder, excluding any taxes levied on income.

**26.2 Taxes And Fees Imposed Directly On Either Seller Or Purchaser**

**26.2.1 Taxes and fees imposed on the providing Party, which are neither permitted nor required to be passed on by the providing Party to its Customer, shall be borne and paid by the providing Party.**

**26.2.2 Taxes and fees imposed on the purchasing Party, which are not required to be collected and/or remitted by the providing Party, shall be borne and paid by the purchasing Party.**

**26.3 Taxes And Fees Imposed On Purchaser But Collected And Remitted By Seller**

**26.3.1 Taxes and fees imposed on the purchasing Party shall be borne by the purchasing Party, even if the obligation to collect and/or remit such taxes or fees is placed on the providing Party.**

**26.3.2 To the extent permitted by Applicable Law, any such taxes and/or**

## MCImetro-BellSouth Florida Interconnection Agreement

fees shall be shown as separate items on applicable billing documents between the Parties. Notwithstanding the foregoing, the purchasing Party shall remain liable for any such taxes and fees regardless of whether they are actually billed by the providing Party at the time that the respective service is billed.

26.3.3 If the purchasing Party determines that in its opinion any such taxes or fees are not lawfully due, the providing Party shall not bill such taxes or fees to the purchasing Party if the purchasing Party provides written certification, reasonably satisfactory to the providing Party, stating that it is exempt or otherwise not subject to the tax or fee, setting forth the basis therefor, and satisfying any other requirements under applicable law. If any authority seeks to collect any such tax or fee that the purchasing Party has determined and certified not to be lawfully due, or any such tax or fee that was not billed by the providing Party, the purchasing Party may contest the same in good faith, at its own expense. In the event that such contest must be pursued in the name of the providing Party, the providing Party shall permit the purchasing Party to pursue the contest in the name of providing Party. In the event of any such contest, the purchasing Party shall furnish the providing Party with notice of the pending proceeding, the final resolution thereof and any action therein that would affect the providing party's obligation to collect and remit.

26.3.4 In the event that all or any portion of an amount sought to be collected must be paid in order to contest the imposition of any such tax or fee, or to avoid the existence of a lien on the assets of the providing Party during the pendency or such contest, the purchasing Party shall be responsible for such payment and shall be entitled to the benefit of any refund or recovery.

26.3.5 Left blank intentionally.

26.3.6 Notwithstanding any provision to the contrary, the purchasing Party shall protect, indemnify and hold harmless (and defend at the purchasing Party's expense) the providing Party from and against any such tax or fee, interest or penalties thereof, or other charges or payable expenses (including reasonable attorney fees) with respect thereto, which are reasonably and necessarily incurred by the providing Party in connection with any claim for or contest of any such tax or fee.

26.3.7 Each Party shall provide the other Party with timely written notice of any assessment, proposed assessment or other claim for any additional amount of such a tax or fee by a taxing authority.



**26.4 Taxes And Fees Imposed On Providing Party**

**26.4.1 Taxes and fees imposed on the providing Party, which are permitted or required to be passed on by the providing Party to its Customer, shall be borne by the purchasing Party.**

**26.4.2 To the extent permitted by applicable law, any such taxes and/or fees shall be shown as separate items on applicable billing documents between the Parties. Notwithstanding the foregoing, the purchasing Party shall remain liable for any such taxes and fees regardless of whether they are actually billed by the providing Party at the time that the respective service is billed.**

**26.4.3 If the purchasing Party disagrees with the providing Party's determination as to the application or basis for any such tax or fees, the parties shall consult with respect to the imposition and billing of such tax or fee and with respect to whether to contest the imposition of such tax or fee. Notwithstanding the foregoing, the providing Party shall retain responsibility for determining whether and to what extent any such taxes or fees are applicable. The providing Party shall further retain responsibility for determining whether and how to contest the imposition of such taxes or fees, provided, however, the Parties agree to consult in good faith as to such contest and that any such contest undertaken at the request of the purchasing Party shall be at the purchasing Party's expense. In the event that such contest must be pursued in the name of the providing Party, providing Party shall permit purchasing Party to pursue the contest in the name of the providing Party and the providing Party shall have the opportunity to participate fully in the preparation of such contest.**

**26.4.4 If, after consultation in accordance with the preceding Section 26.4.3, the purchasing Party does not agree with the providing Party's final determination as to the application or basis of a particular tax or fee, and if the providing Party, after receipt of a written request by the purchasing Party to contest the imposition of such tax or fee with the imposing authority, fails or refuses to pursue such contest or to allow such contest by the purchasing Party, the purchasing Party may utilize the dispute resolution process outlined in Section 16 of the General Terms and Conditions of this Agreement and Attachment 1. Utilization of the dispute resolution process shall not relieve the purchasing party from liability for any tax or fee billed by the providing Party pursuant to this subsection during the pendency of such dispute resolution proceeding. In the event that the purchasing Party prevails in such dispute resolution proceeding, it shall be entitled to a refund in accordance with the final decision therein. Notwithstanding the foregoing, if at any time prior to a**

final decision in such dispute resolution proceeding the providing Party initiates a contest with the imposing authority with respect to any of the issues involved in such dispute resolution proceeding, the dispute resolution proceeding shall be dismissed as to such common issues and the final decision rendered in the contest with the imposing authority shall control as to such issues.

26.4.5 In the event that all or any portion of an amount sought to be collected must be paid in order to contest the imposition of any such tax or fee with the imposing authority, or to avoid the existence of a lien on the assets of the providing Party during the pendency of such contest, the purchasing Party shall be responsible for such payment and shall be entitled to the benefit of any refund or recovery.

26.4.6 Left blank intentionally.

26.4.7 Notwithstanding any provision to the contrary, the purchasing Party shall protect, indemnify and hold harmless (and defend at the purchasing Party's expense) the providing Party from and against any such tax or fee, interest or penalties thereon, or other reasonable charges or payable expenses (including reasonable attorney fees) with respect thereto, which are incurred by the providing Party in connection with any claim for or contest of any such tax or fee.

26.4.8 Each Party shall provide the other Party with timely written notice of any assessment, proposed assessment or other claim for any additional amount of such a tax or fee by a taxing authority.

#### 26.5 Mutual Cooperation

Unless otherwise provided herein, in any contest of a tax or fee by one Party, the other Party shall cooperate fully by providing records, testimony and such additional information or assistance as may reasonably be necessary to pursue the contest. Further, the other Party shall be reimbursed for any reasonable and necessary out-of-pocket copying and travel expenses incurred in assisting in such contest.

### ***Section 27. Responsibility for Environmental Contamination***

27.1 MCIm shall in no event be liable to BellSouth for any costs whatsoever resulting from the presence or release of any environmental hazard that MCIm did not introduce to the affected work location so long as MCIm's actions do not cause or substantially contribute to the release of any Environmental Hazard. BellSouth shall, at MCIm's request, indemnify, defend, and hold harmless MCIm, each of its officers, directors and employees from and against

## MCImetro-BellSouth Florida Interconnection Agreement

any losses, damages, claims, demands, suits, liabilities, fines, penalties and expenses (including reasonable attorneys fees) that arise out of or from (i) any environmental hazard that BellSouth, its contractors or agents introduce to the work locations or (ii) the presence or release of any environmental hazard for which BellSouth is responsible under Applicable Law, to the extent the release of any Environmental Hazard is not caused or substantially contributed to by MCIm's actions.

27.2 BellSouth shall in no event be liable to MCIm for any costs whatsoever resulting from the presence or release of any environmental hazard that BellSouth did not introduce to the affected work location, so long as BellSouth's actions do not cause or substantially contribute to the release of any Environmental Hazards. MCIm shall, at BellSouth's request, indemnify, defend, and hold harmless BellSouth, each of its officers, directors and employees from and against any losses, damages, claims, demands, suits, liabilities, fines, penalties and expenses (including reasonable attorneys' fees) that arise out of or result from (i) any environmental hazard that MCIm, its contractors or agents introduce to the work locations, or (ii) the presence or release of any environmental hazard for which MCIm is responsible under applicable law to the extent the release of any Environmental Hazard is not caused or substantially contributed to by BellSouth's actions.

### ***Section 28. Amendments and Modifications***

No provision of this Agreement shall be deemed waived, amended or modified by either party unless such a waiver, amendment or modification is in writing, dated, and signed by both parties.

### ***Section 29. Severability***

Subject to Section 2 - Regulatory Approvals, if any part of this Agreement is held to be invalid for any reason, such invalidity will affect only the portion of this Agreement which is invalid. In all other respects this Agreement will stand as if such invalid provision had not been a part thereof, and the remainder of the Agreement shall remain in full force and effect.

### ***Section 30: Headings Not Controlling***

The headings and numbering of Sections, Parts and Attachments in this Agreement are for convenience only and shall not be construed to define or limit any of the terms herein or affect the meaning or interpretation of this Agreement.

### ***Section 31. Entire Agreement***

This Agreement, including all Parts and Attachments and subordinate documents

attached hereto or referenced herein, all of which are hereby incorporated by reference herein, constitute the entire matter thereof, and supersede all prior oral or written agreements, representations, statements, negotiations, understandings, proposals, and undertakings with respect to the subject matter thereof.

**Section 32. Counterparts**

This Agreement may be executed in counterparts. Each counterpart shall be considered an original and such counterparts shall together constitute one and the same instrument.

**Section 33. Successors and Assigns**

This Agreement shall be binding upon, and inure to the benefit of, the parties hereto and their respective successors and permitted assigns.

**Section 34.**

The parties acknowledge that the terms of this agreement were established pursuant to an order of the Florida Public Service Commission. Any or all of the terms of this agreement may be altered or abrogated by a successful challenge to the agreement (or to the order approving the agreement) as permitted by applicable law. By signing this agreement, the parties do not waive their right to pursue such a challenge.

**Section 35 Effective Date**

This Agreement shall be deemed Effective when signed by the Parties and approved by the Florida Public Service Commission.

**Signature Page Follows**

MCImetro-BellSouth Florida Interconnection Agreement

IN WITNESS WHEREOF, each of the parties has caused this Agreement to be executed by its duly authorized representatives.

MCImetro Access Transmission  
Inc.

BellSouth Telecommunications, Service,  
Inc.

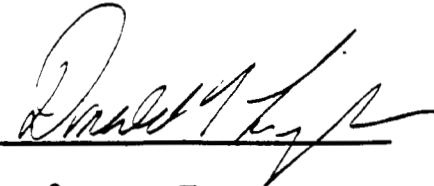
By: 

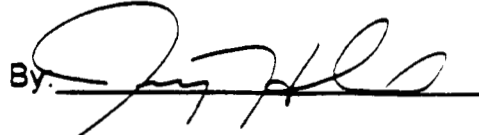
By: 

Name: Donald T. Lynch

Name: Jerry D. Hendrix

Title: Sr. Vice President - Financial Operations

Title: Director

Date: May 12, 1997

Date: June 3, 1997

**EXHIBIT 1**

**BONA FIDE REQUEST PROCESS**

1.0 Bona Fide Requests are to be used when MCI requests a change to any Services and Elements provided hereunder, including features, capabilities, or functionality.

1.1 A Bona Fide Request shall be submitted in writing by MCI and shall specifically identify the required service date, technical requirements, space requirements and/or such specifications that clearly define the request such that BellSouth has sufficient information to analyze and prepare a response. Such a request also shall include, MCI's designation of the request as being (i) pursuant to the Telecommunications Act of 1996 or (ii) pursuant to the needs of the business.

1.2 Although not expected to do so, MCI may cancel, without penalty, a Bona Fide Request in writing at any time. BellSouth will then cease analysis of the request.

1.3 Within two (2) business days of its receipt, BellSouth shall acknowledge in writing, the receipt of the Bona Fide Request and identify a single point of contact and any additional information needed to process the request.

1.4 Except under extraordinary circumstances, within thirty (30) days of its receipt of a Bona Fide Request, BellSouth shall provide to MCI a preliminary analysis of the Bona Fide Request. The preliminary analysis will include BellSouth's proposed price (plus or minus 25 percent) and state whether BellSouth can meet MCI's requirements, the requested availability date, or, if BellSouth cannot meet such date, provide an alternative proposed date together with a detailed explanation as to why BellSouth is not able to meet MCI's requested availability date. BellSouth also shall indicate in this analysis its agreement or disagreement with MCI's designation of the request as being pursuant to the Act or pursuant to the needs of the business. If BellSouth does not agree with MCI's designation, it may utilize the Dispute Resolution Process provided in this Agreement. In no event, however, shall any such dispute delay BellSouth's processing of the request. If BellSouth determines that it is not able to provide MCI with a preliminary analysis with thirty (30) days of BellSouth's receipt of a Bona Fide Need request, BellSouth will inform MCI as soon as practicable. MCI and BellSouth will then determine a mutually agreeable date for receipt of the preliminary analysis.

## MCImetro-BellSouth Florida Interconnection Agreement

1.5 As soon as possible, but in no event more than ninety (90) days after receipt of the request, BellSouth shall provide MCIm with a firm Bona Fide Request quote which will include at a minimum, the firm availability date, the applicable rates and the installation intervals, and a binding price quote.

1.6 Unless MCIm agrees otherwise, all proposed prices shall be the pricing principles of this Agreement, in accordance with the Act, and any applicable FCC and Commission rules and regulations. Payments for services purchased under a Bona Fide Request will be made as specified in this Agreement, unless otherwise agreed to by MCIm.

Within thirty (30) days after receiving the firm Bona Fide Request quote from BellSouth, MCIm will notify BellSouth in writing of its acceptance or rejection of BellSouth's proposal. If at any time an agreement cannot be reached as to the terms and conditions or price of the request, or if BellSouth responds that it cannot or will not offer the requested item in the Bona Fide Request and MCIm deems the item essential to its business operations, and deems BellSouth's position to be inconsistent with the Act, FCC or Commission regulations and/or the requirements of this Agreement, the Dispute Resolution Process set forth in this Agreement may be used by either Party to reach a resolution.

## **PART B -- DEFINITIONS**

**"911 SITE ADMINISTRATOR"** is a person assigned by MCIm to establish and maintain E911 service location information for its subscribers.

**"911 SERVICE"** means a universal telephone number which gives the public direct access to the Public Safety Answering Point (PSAP). Basic 911 service collects 911 calls from one or more local exchange switches that serve a geographic area. The calls are then sent to the correct authority designated to receive such calls.

**"ASR" (ACCESS SERVICE REQUEST)** means the industry standard forms and supporting documentation used for ordering Access Services. The ASR may be used to order trunking and facilities between MCIm and ILEC for Local Interconnection.

**"ACCESS SERVICES"** refers to interstate and intrastate switched access and private line transport services.

**"ACT"** means the Communications Act of 1934 as amended.

**"AIN" (ADVANCED INTELLIGENT NETWORK)** is a network functionality that permits specific conditions to be programmed into a switch which, when met, directs the switch to suspend call processing and to receive special instructions for further call handling instructions in order to enable carriers to offer advanced features and services.

**"AFFILIATE"** is a person that (directly or indirectly) owns or controls, is owned or controlled by, or is under common ownership or control with, another person. For the purposes of this paragraph, the term "own" means to own an equity interest (or the equivalent thereof) of more than 10 percent.

**"ALI" (AUTOMATIC LOCATION IDENTIFICATION)** is a proprietary database developed for E911 systems that provides for a visual display of the caller's telephone number, address and the names of the emergency response agencies that are responsible for that address. The Alternative Local Exchange Company will provide ALI record information in National Emergency Number Association (NENA) Version #2 format. The ALI also shows an Interim Number Portability (INP) number if applicable.



**"ALI/DMS" (AUTOMATIC LOCATION IDENTIFICATION/DATA MANAGEMENT SYSTEM)** means the emergency service (E911/911) database containing customer location information (including name, address, telephone number, and sometimes special information from the local service provider) used to determine to which Public Safety Answering Point (PSAP) to route the call.

**"AMA"** means the Automated Message Accounting structure inherent in switch technology that initially records telecommunication message information. AMA format is contained in the Automated Message Accounting document, published by Bellcore as GR-1100-CORE which defines the industry standard for message recording.

**"ANI" (AUTOMATIC NUMBER IDENTIFICATION)** is a feature that identifies and displays the number of a telephone that originates a call.

**"ARS" (AUTOMATIC ROUTE SELECTION)** is a service feature that provides for automatic selection of the least expensive or most appropriate transmission facility for each call based on criteria programmed into the system.

**"BLVBLI" (Busy LINE VERIFY/BUSY LINE INTERRUPT)** means an operator call in which the end user inquires as to the busy status of, or requests an interruption of, a call on an Exchange Service.

**"BellSouth" and "BST"** both mean BellSouth Telecommunications, Inc.

**"CABS"** means the Carrier Access Billing System which is defined in a document prepared under the direction of the Billing Committee of the OBF. The Carrier Access Billing System document is published by Bellcore in Volumes 1, 1A, 2, 3, 3A, 4 and 5 as Special Reports SR-OPT-001868, SR-OPT-001869, SR-OPT-001871, SR-OPT-001872, SR-OPT-001873, SR-OPT-001874, and SR-OPT-001875, respectively, and contains the recommended guidelines for the billing of access and other connectivity services.

**"CCS" (COMMON CHANNEL SIGNALING)** means a method of digitally transmitting call set-up and network control data over a digital signaling network fully separate from the public switched telephone network that carries the actual call.

**"CLEC"** means a Competitive Local Exchange Carrier.

**"CPN"** (CALLING PARTY NUMBER) is a Common Channel Signaling parameter which refers to the number transmitted through the network identifying the calling party.

**"CENTRAL OFFICE SWITCH"** or **"CENTRAL OFFICE"** means a switching entity within the public switched network, including but not limited to end office switches and tandem office switches. Central office switches may be employed as combination End Office/Tandem Office Switches (Combination Class 5/Class 4).

**"CENTREX"** means a Telecommunications Service that uses central office switching equipment for call routing to handle direct dialing of calls, and to provide numerous private branch exchange-like features.

**"CHARGE NUMBER"** is a CCS parameter which refers to the number transmitted through the network identifying the billing number of the calling party.

**"CLASS"** (Bellcore Service Mark) – Set of call-management service features that utilize the capability to forward a calling party's number between end offices as part of call setup. Features include Automatic Callback, Automatic Recall, Caller ID, Call Trace, and Distinctive Ringing.

**"COLLOCATION"** means the right of MCI/m to place equipment of its choice in BellSouth's central offices or other BellSouth locations as described in the rules and regulations of the FCC in effect.

**"COMBINATIONS"** means provision by ILEC of two or more connected Network Elements ordered by MCI/m to provide its telecommunication services in a geographic area or to a specific customer and that are placed on the same order by MCI/m.

**"COMMISSION"** means the Florida Public Service Commission.

**"CONDUIT"** means a tube or protected pathway that may be used to house communication or electrical cables. Conduit may be underground or above ground (for example, inside buildings) and may contain one or more inner ducts.

**"CONFIDENTIAL INFORMATION"** has that meaning set forth in

Section 21 of Part A – General Terms.

**“CONTRACT YEAR”** means a twelve (12) month period during the term of the contract commencing on the Effective Date and each anniversary thereof.

**“CONTROL OFFICE”** is an exchange carrier center or office designated as its company's single point of contact for the provisioning and maintenance of its portion of local interconnection arrangements.

**“CUSTOM CALLING FEATURES”** – Set of call-management service features available to residential and single-line business customers including call-waiting, call-forwarding and three-party calling.

**“DBMS” (DATABASE MANAGEMENT SYSTEM)** is a computer system used to store, sort, manipulate and update the data required to provide selective routing and ALI.

**“DIRECTORY ASSISTANCE DATABASE”** refers to any subscriber recorder used by the ILEC in its provision of live or automated operator-assisted directory assistance including but not limited to 411, 555-1212, NPA-555-1212.

**“DIRECTORY ASSISTANCE SERVICES”** provides Listings to callers. Directory Assistance Services may include the option to complete the call at the caller's direction.

**“DIRECTORY LISTINGS”** refers to subscriber information, including but not limited to name, address and phone numbers, that is published in any media, including but not limited to traditional white/yellow page directories, specialty directories, CD ROM, and other electronic formats.

**“DISCLOSER”** means that party to this Agreement which has disclosed Confidential Information to the other party.

**“E911” (ENHANCED 911 SERVICE)** means a telephone communication service which will automatically route a call dialed “911” to a designated public safety answering point (PSAP) attendant and will provide to the attendant the calling party's telephone number and, when possible, the address from which the call is being placed and the emergency response agencies responsible for the location from which the call was dialed.

**"E911 Message Trunk"** is a dedicated line, trunk or channel between two central offices or switching devices which provides a voice and signaling path for E911 calls.

**"EIS" (EXPANDED INTERCONNECTION SERVICE)** is the collocation arrangement which ILEC provides in its designated wire centers.

**"EMR"** means the Exchange Message Record System used among ILECs for exchanging telecommunications message information for billable, non-billable, sample, settlement and study data. EMR format is contained in BR-010-200-010 CRIS Exchange Message Record, published by Bellcore and which defines the industry standard for exchange message records.

**"ESN" (EMERGENCY SERVICE NUMBER)** is a number assigned to the ALI and selective routing databases for all subscriber telephone numbers. The ESN designates a unique combination of fire, police and emergency medical service response agencies that serve the address location of each in-service telephone number.

**"EFFECTIVE DATE"** is the date indicated in Part A on which the Agreement shall become effective.

**"EMERGENCY RESPONSE AGENCY"** is a governmental entity authorized to respond to requests from the public to meet emergencies.

**"ENHANCED DIRECTORY ASSISTANCE"** refers to directory Assistance services, including but not limited to reverse search, talking yellow pages, and locator services.

**"ENHANCED WHITE PAGES"** means optional features available for White Pages Directory listings (e.g., bold, all capitals, logos).

**"ENHANCED YELLOW PAGES"** means optional features available for Yellow Pages Directory listings (e.g., red type, bold, all capital, additional line of text, indented).

**"ENVIRONMENTAL HAZARD"** means (1) a release, discharge, leak, spill or disposal (collectively referred to hereafter as "release") of HAZARDOUS MATERIALS has occurred on premises or property that is related to the performance of this Agreement and that such affected material or media is demonstrated through

## MCImetro-BellSouth Florida Interconnection Agreement

applicable or appropriate testing method to require remediation or removal as determined by all laws, ordinances, statutes, codes, rules, regulations, orders and decrees of the United States, the state, county, city or any other political subdivision in which the release has occurred, and any other political subdivision in which the release has occurred, and any other political subdivision, agency, or instrumentality exercising jurisdiction over the release, including any applicable federal and state case law and common law interpreting any of the foregoing or (2) any event involving, or exposure to, HAZARDOUS MATERIALS which poses risks to human health, safety or the environment (including, without limitation, indoor or outdoor environment(s) and is regulated under any applicable laws or regulations as described in (1).

"FCC Interconnection Order" is the Federal Communications Commission's First Report and Order in CC Docket No. 96-98 released August 8, 1996.

"HAZARDOUS MATERIALS" means any hazardous or toxic substance, material or waste listed in the United States Department of Transportation HAZARDOUS MATERIALS Table at 49 CFR 172.101; and hazardous substance listed by the Environmental Protection Agency (EPA) under the Comprehensive Environmental, Response, Compensation, and Liability Act (CERCLA), 42 U.S.C. sec. 9601, et. seq., as amended, and found at 40 CFR Part 302; any hazardous waste listed under the Resource Conservation and Recovery Act (RCRA), 42 U.S.C. sec. 6901, et. seq., as amended, and found at 40 CFR Part 261; any toxic substance regulated by the Toxic Substances Control Act, 15 U.S.C. sec. 2601, et. seq., as amended; any insecticide, fungicide, or rodenticide regulated by the Federal Insecticide, Fungicide, and Rodenticide Act, 7 U.S.C. sec. 136, et. seq., as amended; and the following specified substances or materials, that may or may not be regulated by the above; (1) asbestos or asbestos-containing materials; (2) petroleum or petroleum-based or derived products or by-product; (3) polychlorinated biphenyl's (PCBs); and (4) radon."

"ILEC" means the incumbent local exchange carrier.

"INP" (INTERIM NUMBER PORTABILITY) is a service arrangement whereby subscribers who change local service providers may retain existing telephone numbers when remaining at their current location or changing their location within the geographic area serviced by the initial carrier's serving central office.

MCImetro-BellSouth Florida Interconnection Agreement

"IP" (INTERCONNECTION POINT) is a mutually agreed upon point of demarcation where the networks of ILEC and MCI<sub>m</sub> interconnect for the exchange of traffic.

"IXC" (INTEREXCHANGE CARRIER) means a provider of interexchange telecommunications services.

"LIDB" (LINE INFORMATION DATA BASE(S)) A Service Control Point (SCP) database that provides for such functions as calling card validation for telephone line number cards issued by ILECs and other entities and validation for collect and billed-to-third services.

"MCI" means MCI Telecommunications Corporation.

"MCI<sub>m</sub>" means MCImetro Access Transmission Services, Inc.

"MCI<sub>m</sub> 911 DATABASE RECORDS" are the MCI<sub>m</sub> customer records to be provided by MCI<sub>m</sub> to ILEC for inclusion in ILEC's E911 database.

"MECAB" refers to the Multiple Exchange Carrier Access Billing (MECAB) document prepared by the Billing Committee of the Ordering and Billing Forum (OBF), which functions under the auspices of the Carrier Liaison Committee (CLC) of the Alliance for Telecommunications Industry Solutions (ATIS). The MECAB document, published by Bellcore as Special Report SR-BDS-000983, contains the recommended guidelines for the billing of an access service provided by two or more LECs (including a LEG and a CLEC), or by one LEC in two or more states within a single LATA.

"MECOD" refers to the Multiple Exchange Carriers Ordering and Design (MECOD) Guidelines for Access Services - Industry Support Interface, a document developed by the Ordering/Provisioning Committee under the auspices of the Ordering and Billing Forum (OBF), which functions under the auspices of the Carrier Liaison Committee (CLC) of the Alliance for Telecommunications Industry Solutions (ATIS). The MECOD document, published by Bellcore as Special Report SR STS-002643, establishes recommended guidelines for processing orders for access service which is to be provided by two or more LECs (including a LEG and a CLEC). It is published by Bellcore as SRBDS 00983.

**"MSAG" (MASTER STREET ADDRESS GUIDE (MSAG))** is a database defining the geographic area of an E911 service. It includes an alphabetical list of the street names, high-low house number ranges, community names, and emergency service numbers provided by the counties or their agents to ILEC.

**"NANP"** means the "North American Numbering Plan," the system or method of telephone numbering employed in the United States, Canada, and certain Caribbean countries. It denotes the three digit Numbering Plan Area code and a seven digit telephone number made up of a three digit Central Office code plus a four digit station number.

**"NENA" (NATIONAL EMERGENCY NUMBER ASSOCIATION (NENA))** is an association with a mission to foster the technological advancement, availability and implementation of 911 nationwide.

**"NP" (NUMBER PORTABILITY)** means the ability of users of telecommunications services to retain, at the same location, existing telecommunications numbers without impairment of quality, reliability, or convenience when switching from one telecommunications carrier to another.

**"NPA" (NUMBERING PLAN AREA)** (sometimes referred to as an area code). Is the three digit indicator which is designated by the first three digits of each 10 digit telephone number within the NANP. Each NPA contains 800 possible NXX Codes. There are two general categories of NPA, "Geographic NPAs" and "Non-Geographic NPAs." A "Geographic NPA" is associated with a defined geographic area, and all telephone numbers bearing such NPA are associated with services provided within that Geographic area. A "Non-Geographic NPA," also known as a "Service Access Code (SAC Code)" is typically associated with a specialized telecommunications service which may be provided across multiple geographic NPA areas; 500, 800, 900, 700, and 888 are examples of Non-Geographic NPAs.

**"NXX," "NXX CODE," OR "CENTRAL OFFICE CODE," OR "CO CODE"** is the three digit switch entity indicator which is defined by the fourth, fifth and sixth digits of a 10 digit telephone number within the North America Numbering Plan ("NANP").

**"NETWORK ELEMENT"** means a facility or equipment used in the provision of a telecommunications service including all features, functions and capabilities that are embedded in such facility or equipment.

"OBF" means the Ordering and Billing Forum, which functions under the auspices of the Carrier Liaison Committee (CLC) of the Alliance for Telecommunications Industry Solutions (ATIS).

"OPERATOR SYSTEMS" are network elements that provide operator and automated call handling with billing, special operator services, subscriber telephone listings and optional call completion services.

"OPERATOR SERVICES" provides (1) operator handling for call completion (e.g. collect calls); (2) operator or automated assistance for billing after the customer has dialed the called number (e.g. credit card calls); and (3) special operator services (e.g. BLV/ELI, Emergency Agency Call).

"P.01 TRANSMISSION GRADE OF SERVICE (GOS)" means a trunk facility provisioning standard with the statistical probability of no more than one call in 100 blocked on initial attempt during the average busy hour.

"PLU" (PERCENT LOCAL USAGE) is a calculation which represents the ratio of the local minutes to the sum of local and intraLATA toll minutes and interLATA minutes, if any, between exchange carriers sent over Local Interconnection Trunks. Directory assistance, BLV/BLVI, 900, 976, transiting calls from other exchange carriers and switched access calls are not included in the calculation of PLU. "POP" means an IXC's point of presence.

"PSAP" (PUBLIC SAFETY ANSWERING POINT (PSAP)) is the public safety communications center where 911 calls placed by the public for a specific geographic area will be answered

"POLE ATTACHMENT" means any attachment by a cable television system or provider of telecommunications service to a pole, duct, conduit, or right-of-way owned or controlled by a utility.

"PROPRIETARY information" shall have the same meaning as Confidential Information.

"ROW" (RIGHT OF WAY (ROW)) is the right to use the land or other property of another party to place poles, conduits, cables, other structures and equipment, or to provide passage to access such structures and equipment.

"RATE CENTER" means the geographic point and corresponding



geographic area which are associated with one or more particular NPA-NXX codes which have been assigned to ILEC (or MCIm) for its provision of Basic Exchange Telecommunications Services. The "rate center point" is the finite geographic point identified by a specific V&H coordinate, which is used to measure distance-sensitive end user traffic to/from the particular NPA-NXX designations associated with the specific Rate Center. The "rate center area" is the exclusive geographic area identified as the area within which ILEC (or MCIm) will provide Basic Exchange Telecommunications Services bearing the particular NPA-NXX designations associated with the specific Rate Center. The Rate Center point must be located within the Rate Center area.

"REAL TIME" means the actual time in which an event takes place, with the reporting on or the recording of the event simultaneous with its occurrence.

"RECIPIENT"- means that party to this Agreement (a) to which Confidential Information has been disclosed by the other party or (b) who has obtained Confidential Information in the course of providing services under this Agreement.

"RESELLER" is a category of Local Exchange service providers who obtain dial tone and associated telecommunications services from another provider through the purchase wholesale priced services for resale to their end user customers.

"ROUTING POINT" means a location which ILEC or MCIm has designated on its own network as the homing (routing) point for traffic inbound to Basic Exchange Services provided by the ILEC or MCIm which bear a certain NPA-NXX designation. The Routing Point is employed to calculate mileage measurements for the distance-sensitive transport element charges of Switched Access Services. Pursuant to Bellcore Practice BR 795-100-100, the Routing Point may be an "End Office" location, or a "LEC Consortium Point of Interconnection." Pursuant to that same Bellcore Practice, examples of the latter shall be designated by a common language location identifier (CLLI) code with (x)KD in positions 9, 10, 11, where (x) may be any alphanumeric A-Z or 0-9. The above referenced Bellcore document refers to the Routing Point as the Rating Point. The Rating Point/Routing Point need not be the same as the Rate Center Point, nor must it be located within the Rate Center Area, but must be in the same LATA as the NPA-NXX..

"SECAB" means the Small Exchange Carrier Access Billing

## MCImetro-BellSouth Florida Interconnection Agreement

document prepared by the Billing Committee of the OBF. The Small Exchange Carrier Access Billing document, published by Bellcore as Special Report SR OPT-001856, contains the recommended guidelines for the billing of access and other connectivity services.

"SELECTIVE ROUTING" is a service which automatically routes an E911 call to the PSAP that has jurisdictional responsibility for the service address of the telephone that dialed 911, irrespective of telephone company exchange or wire center boundaries.

"SWITCH" – See Central Office Switch

"TANDEM OFFICE SWITCHES" which are Class 4 switches which are used to connect and switch trunk circuits between and among end office switches and other tandems.

"TECHNICALLY FEASIBLE" Interconnection, access to Network Elements, collocation, and other methods of achieving interconnection or access to Network Elements at a point in the network shall be deemed technically feasible absent technical or operational concerns that prevent the fulfillment of a request by a telecommunications carrier for such interconnection, access, or methods. A determination of technical feasibility does not include consideration of economic, accounting, billing, space, or site concerns, except that space and site concerns may be considered in circumstances where there is no possibility of expanding the space available. The fact that an incumbent LEC must modify its facilities or equipment to respond to such request does not determine whether satisfying such request is technically feasible. An incumbent LEC that claims that it cannot satisfy such request because of adverse network reliability impacts must prove to the state commission by clear and convincing evidence that such interconnection, access, or methods would result in specific and significant adverse network reliability impacts.

"TELECOMMUNICATIONS" means the transmission, between or among points specified by the user, of information of the user's choosing, without change in the form or content of the information as sent and received.

"TELECOMMUNICATION SERVICES" means the offering of telecommunications for a fee directly to the public, or to such classes of users as to be effectively available directly to the public, regardless of the facilities used. As used in this definition.

MCImetro-BellSouth Florida Interconnection Agreement

"THOUSANDS BLOCK OF NUMBERS" shall mean 1000 or more consecutive numbers beginning and ending on a digit boundary, e.g., 949-1000 to 949-1999.

"TRCO" means Trouble Reporting Control Office.

"VOLUNTARY FEDERAL CUSTOMER FINANCIAL ASSISTANCE PROGRAMS" are Telecommunications Services provided to low-income subscribers, pursuant to requirements established by the appropriate state regulatory body.

"WIRE CENTER"- denotes a building or space within a building which serves as an aggregation point on a given carrier's network, where transmission facilities and circuits are connected or switched. Wire center can also denote a building in which one or more central offices, used for the provision of Basic Exchange Services and access services, are located. However, for purposes of EIC service, Wire Center shall mean those points eligible for such connections as specified in the FCC Docket No. 91 - 141, and rules adopted pursuant thereto.

## ATTACHMENT I

### PRICE SCHEDULE

#### 1. General Principles

1.1 All rates provided under this Agreement are permanent unless otherwise indicated in Table I, subject to true-up, and shall remain in effect until the Commission determines otherwise or unless they are not in accordance with all applicable provisions of the Act, the Rules and Regulations of the FCC in effect, or the Commission's rules and regulations, in which case Part A, Section 2 shall apply.

1.2 Except as otherwise specified in this Agreement, the Act or any Commission order, each Party shall be responsible for all costs and expenses that it incurs to comply with its obligation under this Agreement.

#### 2. Local Service Resale

The rates that MCIm shall pay to BellSouth for Resale shall be an amount equal to BellSouth's tariffed rates for each resold service as reduced by a percentage amount equal to the wholesale discount (set forth below in section 2.1, below). If BellSouth reduces such tariffed rates during the term of this Agreement, the wholesale discount shall be applied to the reduced tariffed rates.

2.1 The following wholesale discount will apply to all Telecommunications Services available for resale in Florida:

Residential Service: 21.83 %

Business Service: 16.81 %

#### 3. Unbundled Network Elements

The charges that MCIm shall pay to BellSouth for Network Elements are set forth in Table 1 of this Attachment.

#### 4. Ancillary Functions and Supporting Elements

The interim prices for collocation, AIN and other Ancillary Functions or Supporting Elements that MCIm shall pay to BellSouth are set forth in Table 1 of this Attachment.

**5. Recorded Usage Data**

The prices for Recorded Usage data are set forth in Table 1 of this Attachment.

**6. Inside Wire**

The price of the BellSouth Inside Wire Maintenance Plan purchased by MCIm for resale shall not be reduced by the wholesale discount.

**7. Interconnection and Reciprocal Compensation**

7.1 Compensation for the exchange of local traffic is set forth in Table 1 of this Attachment and shall be billed based on per-minutes-of-use and shall be measured in accordance with Attachment IV.

7.2 MCIm may choose to establish trunking to any given end office when there is sufficient traffic to route calls directly to such end office. If MCIm leases one-way trunks from BellSouth, MCIm will pay the transport charges for dedicated or common transport. For two-way trunks the charges will be shared equally by both parties.

7.3 Compensation for the termination of toll traffic and the origination of 800/888 traffic between the interconnecting parties shall be based on the applicable access charges in accordance with FCC Rules and Regulations in effect.

7.4 Where a toll call is completed through BellSouth Florida's INP arrangement (e.g., remote call forwarding, flexible DID, etc.) to MCIm's subscriber, MCIm shall be entitled to applicable access charges in accordance with FCC Rules and Regulations.

7.5 MCIm shall pay a transit rate as set forth in Table 1 of this Attachment when MCIm uses an BellSouth access tandem to terminate a call to a third party LEC or another local service provider. BellSouth shall pay MCIm a transit rate equal to the BellSouth rate referenced above when BellSouth uses an MCIm switch to terminate a call to a third party LEC or another local service provider.

8. The recurring and non-recurring prices for Unbundled Network Elements (UNEs) in Table 1 of this Attachment are appropriate for UNEs on an individual, stand-alone basis. When two or more UNEs are combined, these prices may lead to duplicate charges. BellSouth shall provide recurring and non-recurring charges that do not include duplicate charges for functions or activities that MCIm does not need when two or more network elements are combined in a single order. MCIm and BellSouth shall work together to establish the recurring

## MCImetro-BellSouth Florida Interconnection Agreement

and non-recurring charges in situations where MCIm is ordering multiple network elements. Where the parties cannot agree to these charges, either party may petition the Florida Public Service Commission to settle the disputed charge or charges. BellSouth must notify the Commission when a rate is set that excludes duplicated charges by filing a report within 30 days of the rate being established. This report must specify the elements being combined and the charges for that particular combination.

MCImetro/BellSouth Florida Interconnection Agreement

Table 1 (all items/rates not included)

NETWORK ELEMENT	COMMISSION APPROVED RECURRING RATES FOR UNBUNDLED NETWORK ELEMENTS
NETWORK INTERFACE DEVICE	*\$0.75
LOOPS	
2 - WIRE ANALOG	\$17.00
4 - WIRE ANALOG	\$30.00
2 - WIRE ISDN	\$40.00
4 - WIRE DS1	\$80.00
LOOP DISTRIBUTION	*\$7.00
END OFFICE SWITCHING	
PORTS	
2 - WIRE ANALOG	\$2.00
4 - WIRE ANALOG	*\$10.00
2 - WIRE ISDN	\$13.00
4 - WIRE DS1	\$125.00
USAGE	
INITIAL MIN.	\$0.0175
ADD'L MIN.	\$0.005
SIGNALING	
LINK	\$5.00
TERMINATION	\$113.00
USAGE	
- CALL SETUP MSG	\$0.00001
- TCAP MESSAGE	\$0.00004
USAGE SURROGATE	\$64.00
UNBUNDLED LOOP CHANNELIZATION SYSTEM (DS1)	
- PER SYSTEM	\$480.00
- CENTRAL OFFICE CHANNEL INTERFACE - VOICE	\$1.50

MCImetro/BellSouth.Florida Interconnection Agreement

NETWORK ELEMENT	COMMISSION APPROVED RECURRING RATES FOR UNBUNDLED NETWORK ELEMENTS
<b>COMMON TRANSPORT</b>	
PER MILE	\$0.000012
FACILITIES TERMINATION PER MOU	\$0.0005
<b>DEDICATED TRANSPORT (DS1)</b>	
PER MILE	\$1.60
PER FAC. TERM.	\$59.75
<b>TANDEM SWITCHING</b>	\$0.00029
<b>CALL TRANSPORT AND TERMINATION (Compensation for Exchange of Local Traffic)</b>	
<b>END OFFICE INTERCONNECTION INCLUDING TRANSPORT (PER MOU)</b>	\$0.002
<b>TANDEM INTERCONNECTION INCLUDING TRANSPORT (PER A51MOU)</b>	\$0.00125
<b>OPERATOR SYSTEMS</b>	
OPERATOR CALL HANDLING	\$1.00
AUTOMATED CALL HANDLING	\$0.10
BUSY LINE VERIF.	\$0.80
EMERGENCY INTER.	\$1.00
<b>NUMBER SERVICE INTERCEPT</b>	
- PER QUERY	\$0.01
<b>DIRECTORY ASSISTANCE (DA)</b>	\$0.25
<b>DA DABABASE</b>	
- PER LISTING	\$0.001
- MONTHLY	\$100.00
<b>DIRECT ACCESS TO DA SERVICE</b>	
- MONTHLY	\$5,000.00
- PER QUERY	\$0.01
<b>DA CALL COMPLETION</b>	\$0.03
<b>DA TRANSPORT</b>	
- SWITCHED LOCAL CHANNEL	*\$133.81
- SWITCHED DEDICATED	
<b>TRANSPORT DS1 LEVEL</b>	
- PER MILE	*\$16.75
- PER FACILITY TERM.	\$59.75



MCImetro/BellSouth Florida Interconnection Agreement

- SW COMM. / DA CALL	\$0.0003
- SW COMM. / DA CALL/MILE	\$0.00001
- TANDEM SW/DA CALL	\$0.00055

\* Interim Rates

MCImetro/BellSouth Florida Interconnection Agreement

NETWORK ELEMENT	COMMISSION APPROVED NONRECURRING RATES FOR UNBUNDLED NETWORK ELEMENTS
NETWORK INTERFACE DEVICE	*\$0.00
UNBUNDLED LOOP	
2 - WIRE ANALOG	
FIRST	\$140.00
ADDITIONAL	\$42.00
4 - WIRE ANALOG	
FIRST	\$141.00
ADDITIONAL	\$43.00
2 - WIRE ISDN	
FIRST	\$306.00
ADDITIONAL	\$283.00
4 - WIRE DS1	
FIRST	\$540.00
ADDITIONAL	\$465.00
LOOP DISTRIBUTION	* Left Blank Intentionally
END OFFICE SWITCHING	
PORT	
2 - WIRE ANALOG	
FIRST	\$38.00
ADDITIONAL	\$15.00
4 - WIRE ANALOG	
FIRST	*\$38.00
ADDITIONAL	*\$15.00
2 - WIRE ISDN	
FIRST	\$88.00
ADDITIONAL	\$66.00
4 - WIRE DS1	
FIRST	\$112.00
ADDITIONAL	\$91.00
SIGNALING LINK	\$400.00

MCI/metro/BellSouth Florida Interconnection Agreement

NETWORK ELEMENT	COMMISSION APPROVED NONRECURRING RATES FOR UNBUNDLED NETWORK ELEMENTS
<b>UNBUNDLED LOOP CHANNELIZATION SYSTEM</b>	
- PER SYSTEM (DS1 - Voice Grade)	
FIRST	\$350.00
ADDITIONAL	\$90.00
- CENTRAL OFFICE CHANNEL	
FIRST	\$5.75
ADDITIONAL	\$5.50
<b>DEDICATED TRANSPORT</b>	
PER FACILITY TERMINATION	*\$100.49
<b>OPERATOR SYSTEMS</b>	
<b>DIRECT ACCESS TO DA SERVICE</b>	
- SERVICE ESTABLISHMENT CHARGE	\$820.00
<b>DA TRANSPORT</b>	
SWITCHED LOCAL CHANNEL	
FIRST	*\$866.97
ADDITIONAL	*\$486.83
SWITCHED DEDICATED TRANSPORT	
- PER FACILITY TERMINATION	*\$100.49

\* Interim Rates

MCImetro/BellSouth Florida Interconnection Agreement

ITEM		PRICE	
POLES, DUCTS, CONDUITS AND ROW	MAPS		Left Blank Intentionally
	POLE ATTACHMENT		*\$ 4.20 PER POLE
	CONDUIT		*\$ 0.56 PER FOOT
	INNERDUCT		Left Blank Intentionally
	LABOR RATE		Left Blank Intentionally
VIRTUAL COLLOCATION	*The rates for virtual collocation are set forth in Section E20 of BellSouth's Access Service Tariff		
PHYSICAL COLLOCATION		<b>Monthly Recurring</b>	<b>NONRECURRING</b>
	Application Fee		*\$3,850.00
	Space Preparation Fee		ICB
	Space Construction Fee		*\$4,500.00
	Cable Installation - Per Entrance Cable		*\$2,750.00
	Floor Space Zone A, Per Square Foot	*\$ 7.50	
	Floor Space Zone B, Per Square Foot	*\$ 6.75	
	Power, per AMP	*\$5.00	
	Cable Support Structure, Per Entrance Cable	*\$13.35	
	POT Bay (Optional Point of Termination Bay)		
	2-Wire	*\$0.40	
	4-Wire	*\$1.20	
	DS1	*\$1.20	
	DS3	*\$8.00	
	Cross-Connects		
	2-Wire Analog	*\$0.30	*\$15.20 - First
			*\$15.20 - Add'l
	4-Wire Analog	*\$0.50	*\$15.20 - First
			*\$15.20 - Add'l
	DS1	*\$8.00	*\$155.00 - First
			*\$27.00 - Add'l
	DS3	*\$72.00	*\$155.00 - First
			*\$27.00 - Add'l
	Security Escort		
	Basic - 1 <sup>st</sup> half hour		*\$41.00
	Overtime 1 <sup>st</sup> half hour		*\$48.00
	Premium 1 <sup>st</sup> half hour		*\$55.00

MCImetro/BellSouth Florida Interconnection Agreement

ITEM		PRICE
<b>PHYSICAL COLLOCATION (cont)</b>		
	Basic - additional	*\$25.00
	Overtime- additional	*\$30.00
	Premium - additional	*\$35.00
<b>AIN Related Services</b>	Left Blank Intentionally	
<b>LOCAL NUMBER PORTABILITY (1)</b>		
	Service Provider Number Portability - Remote	Left Blank Intentionally
	Service Provider Number Number Portability - Direct Inward Dialed (DID)	Left Blank Intentionally
<b>Note(s):</b>		
1. MCI and BellSouth shall pay its own costs in the provision of interim number portability. MCI and BellSouth shall track their costs of providing interim number portability with sufficient detail to verify the costs, in order to facilitate the Florida PSC's consideration of recovery of these costs in Docket No. 950737-TP.		

\* Interim prices

**TABLE OF CONTENTS**

**Attachment II  
LOCAL RESALE**

Section 1.	Telecommunications Services Provided for Resale	II - 1
Section 2.	General Terms and Conditions for Resale	II - 2
Section 3.	Advanced Intelligent Network	II - 14
Section 4.	Service Functions	II - 14

## **ATTACHMENT II**

### **LOCAL RESALE**

#### ***Section 1. Telecommunications Services Provided for Resale***

1.1 At the request of MCI, and pursuant to the requirements of the Act, FPSC rulings, and FCC Rules and Regulations in effect, BellSouth shall make available to MCI for resale any Telecommunications Service that BellSouth currently provides or may offer hereafter. BellSouth shall also provide Service Functions, as set forth in this Attachment II. The Telecommunications Services and Service Functions provided by BellSouth to MCI pursuant to this Agreement are collectively referred to as "Local Resale."

1.2 To the extent that this Attachment describes services which BellSouth shall make available to MCI for resale pursuant to this Agreement, this list of services is neither all inclusive nor exclusive. All Telecommunications Services of BellSouth which are to be offered for resale are subject to the terms herein, even though they are not specifically enumerated or described.

1.3 **Features and Functions Subject to Resale.** BellSouth agrees to make available for resale all features and functions available in connection with Telecommunications Services, including but not limited to the following:

- Dial tone and ring
- Capability for either dial pulse or touch tone recognition
- Capability to complete calls to any location
- Same extended local calling area
- 1+ IntraLATA toll calling
- PIC 1+ service
- CIC dialing (10XXX)
- Same access to vertical features and functions

1.4 BellSouth will provide MCI with at least the capability to provide an MCI subscriber with the same level of service quality as BellSouth provides its own subscribers with respect to all Telecommunications Services and shall provide such capability in accordance with the relevant requirements of Attachment VIII.

1.5 The specific business process requirements and systems interface requirements are set forth in Attachment VIII.

**Section 2. General Terms and Conditions for Resale**

2.1 Pricing. The prices charged to MCI for Local Resale are set forth in Attachment I of this Agreement.

2.2 *Services Available for Resale.* MCI may resell to any and all classes of end-users Telecommunications Services obtained from BellSouth under this Agreement, except for Lifeline Assistance and Link-Up or similar services, Grandfathered Services and short-term promotions, which MCI may only resell to those subscribers who are eligible to obtain such services from BellSouth. BellSouth will not prohibit, nor impose unreasonable or discriminatory conditions or limitations on, the resale of its Telecommunications Service.

2.2.1 BellSouth agrees to remove all tariff restrictions regarding resale that are inconsistent with the orders of the FPSC pertaining to resale.

2.2.2 *Restrictions on Resale* With the exception of short-term promotions and CSA's( defined below),Lifeline, Link-up, and state specific discount plans for optional extended area calling , BellSouth shall offer for resale at wholesale prices all Telecommunications Services that BellSouth provides at retail to non-telecommunications carriers.

No terms and conditions, including use and user restrictions, shall be applicable to the resale of BellSouth's services except for:

2.2.2.1 A restriction on cross-class selling;

2.2.2.2 Left Blank Intentionally;

2.2.2.3 Left Blank Intentionally;

2.2.2.4 Lifeline service shall be available for resale by MCI only to those subscribers who meet the qualifications set forth in the applicable State and Federal Regulations.

2.2.2.5 Link-up service shall be available for resale by MCI only to those subscribers who meet the qualifications set forth in the applicable State and Federal Regulations.



## MCImetro-BellSouth Florida Interconnection Agreement

2.2.2.6 Grandfathered services are available for resale by MCIm only to those subscribers who already have grandfathered status or who may obtain such services from BellSouth. Grandfathered services may not be resold to a new or different group of subscribers that is not eligible to obtain such services from BellSouth.

2.2.2.7 Left Blank Intentionally

2.2.2.8 Left Blank Intentionally

### 2.3 Requirements for Specific Services

#### 2.3.1 MULTISERV® Requirements

2.3.1.1 At MCIm's option, MCIm may purchase MULTISERV® services. Where MCIm purchases such MULTISERV services, MCIm may purchase the entire set of features, any single feature or any combination of features which BellSouth has the capability to provide. BellSouth will provide MCIm with the same service levels and features of MULTISERV Service provided by BellSouth to its subscribers. Requests by MCIm for MULTISERV Service and features that are different from what BellSouth provides to its subscribers will be handled under the Bona Fide Request Process. The MULTISERV service provided for resale will meet the following requirements;

2.3.1.2 All features and functions of MULTISERV Service, including MULTISERV Management System (CMS), whether offered under tariff or otherwise, shall be available to MCIm for resale, without any geographic or subscriber class restrictions.

2.3.1.3 BellSouth shall make CMS information available to MCIm at the End Office level via an electronic interface as specified in Attachment VIII.

2.3.1.4 BellSouth shall provide to MCIm access to information by central office via an electronic interface, relating to all current MULTISERV® or MULTISERV-like features and functions offered by BellSouth within ten (10) days of the Effective Date of this Agreement. MCIm can obtain updates to information relating to MULTISERV features and functions as required.

## MCImetro-BellSouth Florida Interconnection Agreement

2.3.1.5 All service levels and features of MULTISERV Service provided by BellSouth for resale by MCIm shall meet the service requirements set forth in Attachment VIII.

2.3.1.6 MCIm may aggregate the MULTISERV local exchange and IntraLATA traffic usage of MCIm subscribers to qualify for volume discounts on the basis of such aggregated usage.

2.3.1.7 MCIm may aggregate multiple MCIm subscribers on dedicated access facilities. MCIm may require BellSouth to suppress the need for MCIm subscribers to dial "9" when placing calls outside the MULTISERV System. When dedicated facilities are utilized, BellSouth will provide, upon MCIm's request, station ID or ANI as well as FGD trunking.

2.3.1.8 MCIm may use remote call forwarding, or any other method mutually agreed upon, in conjunction with MULTISERV Service to provide service to MCIm local service subscribers residing outside of the geographic territory in which BellSouth provides local exchange service.

2.3.1.9 MCIm may purchase any and all levels of MULTISERV Service for resale, without restriction on the maximum number of lines that may be purchased for any one level of service. Where minimum number of line restrictions apply, MCIm may aggregate subscribers to satisfy such restrictions. MCIm shall be permitted to resell MULTISERV to multiple and different subscribers of MCIm for purposes of aggregation; provided, however, that the lines must be aggregated within the MCIm-defined common block.

2.3.1.10 BellSouth shall make available to MCIm for resale intercom calling, at the appropriate discount set forth in Attachment I, among all MCIm subscribers within the same MULTISERV system who utilize resold MULTISERV Service. To the extent that BellSouth offers its own subscribers intercom calling between different MULTISERV systems, BellSouth shall make such calling available to MCIm for resale upon the same terms and conditions at the appropriate discount set forth in Attachment I.

## MCImetro-BellSouth Florida Interconnection Agreement

2.3.1.11 MCIm may utilize BellSouth's Automatic Route Selection (ARS) service features to provision and route calls from various end users to various Interexchange Carriers (IXC) Networks.

2.3.1.12 BellSouth's MULTISERV Service may be used by MCIm to provide Local Service as defined by BellSouth to MCIm's subscribers.

### 2.3.2 Voluntary Federal and State Subscriber Financial Assistance Programs

Local Resale is provided to low-income subscribers, pursuant to requirements established by the appropriate state regulatory body, include programs such as Voluntary Federal Subscriber Financial Assistance Program and Link-Up America. When a BellSouth subscriber eligible for the Voluntary Federal Subscriber Financial Assistance Program or other similar state programs chooses to obtain Local Resale from MCIm, BellSouth shall forward all available information regarding such subscriber's eligibility to participate in such programs to MCIm in accordance with procedures to be mutually established by the parties and applicable state and federal law.

**2.3.3 *Lifeline/Link-Up Service.*** BellSouth shall offer for resale Lifeline and Link-Up Service. BellSouth will provide information about the certification process for the provisioning of Lifeline, Link-up, and similar services. MCIm shall discount the Lifeline and Link-Up services by at least the same percentage as now provided by BellSouth. MCIm shall comply with all aspects of the FCC's and Florida PSC's Orders which implement Lifeline and Link-Up programs.

2.3.3.1 BellSouth will forward to MCIm, in electronic format, all information regarding a subscriber's program eligibility, status and certification when a BellSouth subscriber currently on any BellSouth telephone assistance program changes service to MCIm as their local exchange carrier. BellSouth will cooperate in obtaining any subsidy associated with a subscriber transfer to MCIm.

2.3.4 Grandfathered Services. BellSouth shall offer for resale to MCIm all grandfathered services. For purposes of this Agreement, a grandfathered service is a service that BellSouth offers to existing retail subscribers but not to new

## MCImetro-BellSouth Florida Interconnection Agreement

or different subscribers. MCIm shall have the right to review any BellSouth request for the termination of service and/or its grandfathering filed with the Commission.

### 2.3.5 N11 Service

2.3.5.1 BellSouth shall make available for resale any new N11 services after the Effective Date of this Agreement .

2.3.5.2 MCIm shall have the right to resell any N11 service, including but not limited to 911 or E911 services, existing as of the Effective Date.

**2.3.6 *Customer Specific Offerings including Contract Service Arrangements and Other Customer Specific Offerings ("CSAs")***. CSAs shall be available for resale, at the same rates, terms and conditions offered to BellSouth's end users, and in accordance with State and FCC Rules and Regulations. CSAs shall be made available for resale at the lower of the price of the CSA in question less the wholesale discount or the retail price of the services provided under the CSA less the wholesale discount.

2.3.6.1 For purposes of this Agreement, a BellSouth promotion will be considered "short-term" if: the promotion is offered to subscribers for a period of 90 days or less, and is not used to evade the wholesale rate obligation to MCIm, for example, by offering a sequential series of 90-day or less promotional rates to BellSouth subscribers.

2.3.6.2 Short-term promotions are available to MCIm at the retail rate of the underlying service less the wholesale discount or the promotional rate without the wholesale discount. BellSouth shall make all other promotions available to MCIm at the promotional rate reduced by the wholesale discount rate.

2.3.6.3 MCIm shall offer a promotion obtained from BellSouth to customers who would qualify for the promotion if they received it directly from BellSouth; however, MCIm shall otherwise remain free to package and price the resold promotion, other than a short term promotion as defined above, without restriction. A BellSouth promotion for a particular service shall not limit MCIm's ability to obtain that service at the normal rate less the wholesale discount and resell it without regard to subscribers' eligibility for the

## **MCImetro-BellSouth Florida Interconnection Agreement**

promotion.

**2.3.6.4 Special Arrangements shall be available for resale, at the same terms and conditions offered to BellSouth's end users, and in accordance with State and FCC Rules and Regulations. Special Arrangements shall be made available for resale at the price of the Special Arrangement less the wholesale discount.**

**2.3.7 Discount Plans and Services. BellSouth shall offer for resale all tariffed Discount Plans and Services in accordance with State and FCC Rules and Regulations. Except as set forth in 2.2.2.7, Discount Plans and Services shall be made available at the tariffed rate less the wholesale discount.**

**2.3.8 Inside Wire Maintenance Service. BellSouth shall offer for resale inside wire maintenance service at the rates set forth in Attachment I.**

### **2.3.9 Pay Phone Service**

**BellSouth shall make available to MCIm for resale, at charges set forth in Attachment I, all payphone local services, features and functionalities that it provides to its own pay phone operations or to independent pay phone owners. At a minimum the following Pay Phone Services shall be included: Coin Line (currently sold as SmartLine), COCOT Line Coin (currently sold as Independent Payphone Provider (IPP) Line), and COCOT Line Coinless (currently sold as IPP Line Coinless). BellSouth should provide the services and features listed below at the same level and standards as BellSouth provides for its own or an affiliates's pay phone operations. The following features are currently available with these pay phone services and shall be available to MCIm:**

#### **Pay Phone Service**

- **Billed Number Screening**
- **Originating line screening**
- **Ability to "freeze" PIC selection**
- **One bill per line**
- **Point of demarcation at the Network Interface location**

## MCImetro-BellSouth Florida Interconnection Agreement

- Detailed billing showing all 1+ traffic in EMR format and transferred to MCI m via NDM or whatever industry standard may be developed..
- Wire Maintenance option
- Touchtone service
- Option for listed or non-listed numbers
- Access to 911 service
- One directory per line
- Access to ANI information  
Line and/or station monitoring and diagnostic routines.

The following features shall be made available to MCI m when BellSouth provides them to its own pay phone operations or to independent pay phone owners:

- Option to block all 1+ calls to international destinations.
- IntraLATA Call Timing
- Option of one-way or two-way service on line
- Originating line screening
- MCI m rate tables for local and intraLATA service
- Flat rate service based on rate groups
- MCI m resale line incoming/outgoing screening
- Blocking for 1+900, N11, 976, 7 digit local
- Option to block all 1+700 and 1+500 calls
- Line side supervision option
- Ability to keep existing serving telephone numbers if cutover to MCI m
- Far end disconnect recognition
- Call timing
- Same call restrictions as available on BellSouth phones for interLATA, international, intraLATA, and local calling
- Option to have enclosure installed with set
- Install the station to at least BellSouth standards
- Station or enclosure equipment should only bear the name/brand designated by MCI m on the order form
- Provide option for use of "bright station technology including debit cards
- Provide revenue, maintenance, collection reports as specified by MCI m on order form on a periodic basis in paper or electronic formation
- Blocking of inbound international toll calls

## MCImetro-BellSouth Florida Interconnection Agreement

- Point of demarcation at the set location
- Provide service restoration per MCIm's Performance standards
- Service outage transfers to MCIm help center
- Single point of Contact for bills and orders dedicated to Public
- Access to MCIm Directory Assistance
- Access to MCIm's Network Access Interrupt
- Use MCIm branded invoice
- Provide all information requested to ensure MCIm can bill for access line
- Provide all information requested to ensure MCIm can bill for usage on the line
- All calls originating from stations serviced by these lines should be routed to MCI long distance lines
- Provide the same monitoring and diagnostic routines on the line as BellSouth would on its own facilities
- Ordering per MCIm Performance Standards
- Call Transfer per MCIm Performance Standards
- Billing per MCIm Performance Standards
- PIC per MCIm Performance Standards

In addition to the above, the following are specifically for coin lines:

- Access to all CO intelligence required to perform answer detection, coin collection, coin return, and disconnect\*
- Option of measured service
- Ability to block any 1+ service that cannot be rated by the coin circuits/TSPS/OSPS\*
- Option to have BellSouth technicians collect, count, and deposit vault contents on behalf of MCIm
- Monitor vault contents for slugs and spurious non US currency or theft and notify MCIm of discrepancies

**2.3.9.1 BellSouth shall offer for resale at a minimum, the following Coin Line features with its resold Coin Line service:**

Access to all CO intelligence required to perform answer detection, coin collection, coin return, and disconnect  
Answer Detection  
Option to block all 1+ calls to international destinations  
IntraLATA Call Timing  
Option of one-way or two-way service on line

## **MCImetro-BellSouth Florida Interconnection Agreement**

### **Coin Refund and Repair Referral Service**

The following features shall be made available to MCIm when BellSouth provides them to its own pay phone operations or to independent pay phone owners:

#### **Flat Rate Service**

Originating line screening

MCIm rate tables for local and intraLATA service

BellSouth Central Office Intelligence for rating and other functions

Option of measured service

Ability to block any 1+ service that cannot be rated by the coin circuits/ TSPS/OSPS

Protect against clip on fraud

Protect against blue box fraud

2.3.9.2 BellSouth shall offer for resale, at a minimum, the following features with its COCOT Line Coin and COCOT Line Coinless services:

Flat rate or measured rate whichever is offered to BellSouth's IPP Customers

Ability to keep existing service telephone numbers if cutover to MCIm Resale Line

The following features shall be made available to MCIm when BellSouth provides them to its own pay phone operations or to independent pay phone owners:

Originating line screening

Two-way service option

Flat rate service based on rate groups

Option of one-way service on the line

Option of measured service

Ability to keep existing serving telephone numbers if cutover to MCIm resale line incoming/outgoing screening

Provision of Information Digit 29

Provision of International Toll Denial Recognition Tone

2.3.9.3 BellSouth shall offer for resale, at a minimum, the features with its following COCOT Line Coin service:



**MCImetro-BellSouth Florida Interconnection Agreement**

**Blocking for 1+ international, 10XXXX1 + international,  
101XXXX1 + international, 1+900, N111, 976**

**The following features shall be made available to MCI  
when BellSouth provides them to its own pay phone  
operations or to independent pay phone owners:**

**Option to block all 1-700 and 1-500 calls  
Line side supervision option**

**2.3.9.4 BellSouth shall offer for resale, at a minimum, the  
following features with its COCOT Line Coinless-service:**

**Blocking for 1 + international, 10XXXX1 + international,  
101XXXX1 + International, 1+900, N11, 976, 7 or 10  
digit local, 1 + DDD**

**2.3.9.5 BellSouth shall offer for resale, at a minimum, the  
following features with its SemiPublic Coin service:**

**Ability to keep existing serving telephone numbers if  
cutover to MCI  
Touch-tone Service  
Option for listed, nonlisted, or non published numbers  
Provision 911 service  
Access to ANI information  
Access to all CO intelligence required to perform answer  
supervision, coin collect, coin return and disconnect  
Ability to keep existing serving telephone numbers if  
cutover to MCI required to perform answer  
supervision, collect and refund  
Far end disconnect recognition  
Call timing  
PIC protection for all 1+ local, interLATA, and intraLATA  
traffic  
Same call restrictions as available on BellSouth phones  
for interLATA, international, intraLATA, and local  
calling  
One bill per line  
Detailed billing showing all 1+ traffic in paper or  
electronic format  
Option to have enclosure installed with set  
One directory per line installed  
Install the station to at least BellSouth standards**

## **MCImetro-BellSouth Florida Interconnection Agreement**

**Ability to block any 1+ service that cannot be rated by the coin circuits**

**The following features shall be made available to MCIm when BellSouth provides them to its own pay phone operations or to independent pay phone owners:**

**Option to block all 1+ international calls**

**Option of one-way or two-way service**

**Wire Maintenance option**

**Ability to block any 1+ service that cannot be rated by the coin circuits/ TSPS/OSPS**

**Use of MCIm rate tables for local and intraLATA service**

**Option to have BellSouth technicians collect, count, and deposit vault contents on behalf of MCIm**

**Monitor vault contents for slugs and spurious non US currency or theft and notify MCIm of discrepancies**

**Station or enclosure equipment should only bear the name/brand designated by MCIm on the order form**

**Protect against clip on fraud**

**Protect against red box fraud**

**Protect against blue box fraud**

**Provide option for use of "bright" station technology including debit cards**

**Provide revenue, maintenance, collection reports as specified by MCIm on order form on a periodic basis in paper or electronic format**

**Blocking of inbound international calls**

**Point of demarcation at the set location**

**Provide service restoration per MCIm's Performance Standards**

**Service outage transfers to MCIm help center**

**Special screen codes unique to MCIm and/or its subscribers**

**Single point of Contact for bills and orders dedicated to Public Access to MCIm Directory Assistance**

**Access to MCIm's Network Access Interrupt**

**Access to ANI Information**

**Provide all information requested to ensure MCIm can bill for access line**

**Provide all information requested to ensure MCIm can bill for usage on the line**

**All calls originating from stations serviced by these lines should be routed to MCIm lines, except where designated**

## **MCImetro-BellSouth Florida Interconnection Agreement**

**Provide the same monitoring and diagnostic routines on the line as BellSouth would on its own facilities**  
**Provide installation intervals per Performance Standards ordered by the Commission or agreed to by the parties**  
**Ordering per Performance Standards ordered by the Commission or agreed to by the parties**  
**Call Transfer per Performance Standards ordered by the Commission or agreed to by the parties**  
**Billing per Performance Standards ordered by the Commission or agreed to by the parties**  
**PIC per Performance Standards ordered by the Commission or agreed to by the parties**

### **2.3.10 Voice Mail Service**

**2.3.10.1 MCIm shall have the right to resell BellSouth Voice Mail services.**

**2.3.10.2 Where available to BellSouth's end users, BellSouth shall provide the following features and capabilities to allow for voice mail services:**

**SMDI-E (Station Message Desk Interface-Enhanced)**  
**SMDI, Station Message Desk Interface**  
**Message Waiting Indicator ("MWI") stutter dialtone and message waiting light feature capabilities**  
**CF-B/DA (Call Forward on Busy/Don't Answer)**  
**CF/B (Call Forward on Busy)**  
**CF/DA (Call Forward Don't Answer)**

### **2.3.11 Hospitality Service**

**2.3.11.1 BellSouth shall provide all blocking, screening, and all other applicable functions available for hospitality lines.**

**2.3.12 Telephone Line Number Calling Cards. Effective thirty (30) days after the date of an end-user's subscription to MCIm service or within 24 hours after MCIm has notified BellSouth that it has replaced the subscriber's calling card, whichever is earlier, BellSouth will terminate its existing telephone line number-based calling cards and remove any BellSouth-assigned Telephone Line Calling Card Number (including area code) ("TLN") from the LIDB. MCIm may issue a new telephone calling card to such subscriber, utilizing the same TLN, and MCIm shall have the right to enter such**

## **MCImetro-BellSouth Florida Interconnection Agreement**

TLN in LIDB for calling card validation purposes via the service order process. BellSouth will direct-bill each subscriber on the subscriber's final bill. BellSouth will coordinate the disconnection of subscriber's calling cards with MCIm to ensure that there is no time that a subscriber is without a calling card.

### ***Section 3. Advanced Intelligent Network***

3.1.1 MCIm may purchase at the discount set forth in Attachment I any Advanced Intelligent Network (AIN") Telecommunications Services which BellSouth offers at retail, for resale to subscribers who are not carriers.

### ***Section 4. Service Functions***

4.1 BellSouth shall provide MCIm with the information MCIm will need to certify subscribers as exempt from charges (including taxes), or eligible for reduced charges associated with providing services, including but not limited to handicapped individuals, and certain governmental bodies and public institutions and shall not bill MCIm for such services.

4.2 BellSouth shall provide MCIm with appropriate notification of all area transfers with line level detail one hundred twenty (120) days before service transfer, and will also notify MCIm within one hundred twenty (120) days before such change of any LATA boundary changes or within the timeframe required by an approving regulatory body, if any.

4.3 BellSouth will work cooperatively with MCIm in practices and procedures regarding the handling of law enforcement and service annoyance calls.

## TABLE OF CONTENTS

### Attachment III NETWORK ELEMENTS

Section 1.	Introduction	III-1
Section 2.	Unbundled Network Elements	III-1
Section 3.	Standards for Network Elements	III-3
Section 4.	Loop	III-4
Section 5.	Left Blank Intentionally	
Section 6.	Left Blank Intentionally	
Section 7.	Local Switching	III-18
Section 8.	Operator Systems	III-26
Section 9.	Common Transport	III-26
Section 10.	Dedicated Transport	III-30
Section 11.	Signaling Link Transport	III-40
Section 12.	Signaling Transfer Points (STPs)	III-41
Section 13.	Service Control Points/Databases	III-47
Section 14.	Tandem Switching	III-60
Section 15.	Additional Requirements	III-64
Section 16.	Basic 911 and E911	III-106
Section 17.	Directory Assistance Data	III-106

## **ATTACHMENT III**

### **NETWORK ELEMENTS**

#### ***Section 1. Introduction***

BellSouth shall provide unbundled Network Elements in accordance with this Agreement, FCC Rules and Regulations. The price for each Network Element is set forth in Attachment I of this Agreement. Except as otherwise set forth in this Attachment, MCIm may order Network Elements as of the Effective Date.

#### ***Section 2. Unbundled Network Elements***

2.1 BellSouth shall offer Network Elements to MCIm on an unbundled basis on rates, terms and conditions that are just, reasonable, and non-discriminatory in accordance with the terms and conditions of this Agreement.

2.2 BellSouth shall permit MCIm to connect MCIm's facilities or facilities provided to MCIm by third parties with each of BellSouth's unbundled Network Elements at any point designated by MCIm that is Technically Feasible.

2.3 MCIm may use one or more Network Elements to provide any feature, function, capability, or service option that such Network Element(s) is capable of providing or any feature, function, capability, or service option that is described in the technical references identified herein.

2.3.1 MCIm may, at its option, designate any Technically Feasible method of access to unbundled elements, including access methods currently or previously in use.

2.4 BellSouth shall offer each Network Element individually and in combination with any other Network Element or Network Elements in order to permit MCIm to provide Telecommunications Services to its subscribers.

2.5 For each Network Element, BellSouth shall provide a demarcation point (e.g., at a Digital Signal Cross Connect, Light Guide Cross Connect panel or a Main Distribution Frame) and, if necessary, access to such demarcation point, which MCIm agrees is suitable. However, where

**MCImetro-BellSouth Florida Interconnection Agreement**

BellSouth provides combined Network Elements at MCIm's direction, no demarcation point shall exist between such contiguous Network Elements.

2.6 With respect to Network Elements and services in existence as of the Effective Date of this Agreement, charges in Attachment I are inclusive and no other charges apply, including but not limited to any other consideration for connecting any Network Element(s) with other Network Element(s). BellSouth and MCIm agree to attempt in good faith to resolve any alleged errors or omissions in Attachment I.

2.7 This Attachment describes the initial set of Network Elements which MCIm and BellSouth have identified as of the effective date of this agreement:

Loop  
Network Interface Device  
Distribution  
Local Switching

Operator Systems  
Common Transport  
Dedicated Transport  
Signaling Link Transport  
Signaling Transfer Points  
Service Control Points/Databases; and  
AIN capabilities  
Tandem Switching  
911  
Directory Assistance  
Loop Concentrator/Multiplexer

2.8 MCIm and BellSouth agree that the Network Elements identified in this Attachment are not all possible Network Elements.

2.9 MCIm may identify additional or revised Network Elements as necessary to provide telecommunications services to its subscribers, to improve network or service efficiencies or to accommodate changing technologies, subscriber demand, or other requirements.

MCIm will request such Network Elements in accordance with the bona fide request process described in Section 24 of Part A. Additionally, if BellSouth provides any Network Element that is not identified in this Agreement, to itself, to its own subscribers, to a BellSouth Affiliate or to any other entity, BellSouth shall make available the same Network Element to MCIm on terms and conditions no less favorable to MCIm than

those provided to itself or to any other party, at charges set forth in Attachment I.

**Section 3. Standards for Network Elements**

3.1 Each Network Element shall be furnished at a service level equal to or better than the requirements set forth in the technical references referenced in

the following, as well as any performance or other requirements, identified herein. In the event Bell Communications Research, Inc. ("Bellcore"), or industry standard (e.g., American National Standards Institute ("ANSI")) technical reference or a more recent version of such reference sets forth a different requirement, MCI may elect, where Technically Feasible, that such standard shall apply.

3.2 If one or more of the requirements set forth in this Agreement with respect to BellSouth's obligations to MCI are in conflict, MCI shall elect which requirement shall apply.

3.3 Each Network Element provided by BellSouth to MCI shall be at least equal in the quality of design, performance, features, functions, capabilities and other characteristics, including but not limited to levels and types of redundant equipment and facilities for power, diversity and security, that BellSouth provides to itself, BellSouth's own subscribers, to a BellSouth Affiliate or to any other entity.

3.3.1 BellSouth shall provide to MCI, upon request, engineering, design, performance and other network data sufficient for MCI to determine that the requirements of this Section 3 are being met. In the event that such data indicates that the requirements of this Section 3 are not being met, BellSouth shall, within ten (10) days, cure any design, performance or other deficiency, or, if the failure is not susceptible to cure within ten (10) days shall commence and continue its best efforts to correct such failure as soon as possible, and provide new data sufficient for MCI to determine that such deficiencies have been cured.

3.3.2 BellSouth agrees to work cooperatively with MCI to provide Network Elements that will meet MCI's needs in providing services to its subscribers.

3.4 Unless otherwise requested by MCI, each Network Element and the connections between Network Elements provided by BellSouth to MCI



shall be made available to MCIm on a priority basis, at any Technically Feasible point, that is equal to or better than the priorities that BellSouth provides to itself, BellSouth's own subscribers, to a BellSouth Affiliate or to any other entity.

**Section 4. Loop:**

**4.1 Definition**

4.1.1 A loop is a transmission facility between a distribution frame [cross-connect], or its equivalent, in a BellSouth central office or wire center, and the network interface device at a subscriber's premises, to which MCIm's granted exclusive use. This includes, but is not limited to two-wire and four-wire analog voice-grade loops, and two-wire and four-wire loops that are conditioned to transmit the digital signals needed to provide ISDN, ADSL, HDSL, and DS1-level signals. A loop may be composed of the following components:

Loop Concentrator / Multiplexer  
Loop Feeder  
Network Interface Device (NID)  
Distribution

4.1.2 If BellSouth uses Integrated Digital Loop Carrier (IDLCs) systems to provide the local loop, BellSouth will make alternate arrangements, equal in quality, to permit MCIm to order a contiguous unbundled local loop at no additional cost to MCIm except where the absence of existing facilities necessitates special construction.

**4.2. Technical Requirements**

Subdivided to each component as detailed below.

**4.3 Interface Requirements**

Subdivided to each component as detailed below.

**4.4 Loop Components**

**4.4.1 Loop Concentrator/Multiplexer**

**4.4.1.1 Definition:**

**4.4.1.1.1 The Loop Concentrator/Multiplexer is the Network Element that:**

**(1) aggregates lower bit rate or bandwidth signals to higher bit rate or bandwidth signals (multiplexing); (2) disaggregates higher bit rate or bandwidth signals to lower bit rate or bandwidth signals (demultiplexing); (3) aggregates a specified number of signals or channels to fewer channels (concentrating); (4) performs signal conversion, including encoding of signals (e.g., analog to digital and digital to analog signal conversion); and (5) in some instances performs electrical to optical (E/O) conversion.**

**4.4.1.1.2 The Loop Concentrator/Multiplexer function may be provided through a Digital Loop Carrier (DLC) system, channel bank, multiplexer or other equipment at which traffic is encoded and decoded, multiplexed and demultiplexed, or concentrated.**

#### **4.4.1.2 Technical Requirements**

**4.4.1.2.1 The Loop Concentrator/Multiplexer shall be capable of performing its functions on the signals for the following services, including but not limited to, (as needed by MCI to provide end-to-end service capability to its subscriber):**

**4.4.1.2.1.1 two-wire & four-wire analog voice grade loops;**

**4.4.1.2.1.2 two-wire & four-wire loops that are conditioned to transmit the digital signals needed to provide services such as ISDN, ADSL, HDSL, and DS1-level signals.**

**4.4.1.2.1.3 4-wire digital data (2.4Kbps through 64Kbps and n times 64Kbps (where  $n \leq 24$ );**

**4.4.1.2.1.4 DS3 rate private lines;**

**4.4.1.2.1.5 Optical SONET rate private lines;**

**4.4.1.2.2 The Loop Concentrator/Multiplexer shall perform the following functions as appropriate:**

**4.4.1.2.2.1 Analog to digital signal conversion of both incoming and outgoing (upstream and downstream) analog signals;**

**4.4.1.2.2.2 Multiplexing of the individual digital signals up to higher transmission bit rate signals (e.g., DS0, DS1, DS3, or optical SONET rates) for transport to the BellSouth central office through the Loop Feeder; and**

**4.4.1.2.2.3 Concentration of end-user subscriber signals onto fewer channels of a Loop Feeder (The concentration ratio shall be as specified by MCIm).**

**4.4.1.2.3 BellSouth shall provide power for the Loop Concentrator /Multiplexer, through a non-interruptible source if the function is performed in a central office, or from a commercial AC power source with battery backup if the equipment is located outside a central office. Such power shall also adhere to the requirements stated herein.**

**4.4.1.2.4 The Loop Concentrator/Multiplexer shall be provided to MCIm in accordance with the following Technical References:**

**4.4.1.2.4.1 Bellcore TR-NWT-000057, Functional Criteria for Digital Loop Carrier Systems, Issue 2, January 1993.**

**4.4.1.2.4.2 Bellcore TR-NWT-000393, Generic Requirements for ISDN Basic Access Digital Subscriber Lines.**

**4.4.1.2.4.3 ANSI T1.106 - 1988, American National Standard for Telecommunications - Digital Hierarchy - Optical Interface Specifications (Single Mode).**

**4.4.1.2.4.4 ANSI T1.105-1995, American National Standard for Telecommunications -**

Synchronous Optical Network (SONET) - Basic Description including Multiplex Structure, Rates and Formats.

4.4.1.2.4.5 ANSI T1.102-1993, American National Standard for Telecommunications - Digital Hierarchy - Electrical Interfaces.

4.4.1.2.4.6 ANSI T1.403-1989, American National Standard for Telecommunications - Carrier to Subscriber Installation, DS1 Metallic Interface Specification.

4.4.1.2.4.7 Bellcore GR-253-CORE, Synchronous Optical Network Systems (SONET), Common Generic Criteria..

4.4.1.2.4.8 Bellcore TR-TSY-000008, Digital Interface Between the SLC 96 Digital Loop Carrier System and a Local Digital Switch, Issue 2, August 1987.

4.4.1.2.4.9 Bellcore TR-NWT-000303, Integrated Digital Loop Carrier System Generic Requirements, Objectives and Interface, Issue 2, December 1992; Rev. 1, December 1993; Supplement 1, December 1993.

4.4.1.2.4.10 Bellcore TR-TSY-000673, Operations Systems Interface for an IDLC System, (LSSGR) FSD 20-02-2100, Issue 1, September 1989.

4.4.1.2.4.11 Bellcore Integrated Digital Loop Carrier System Generic Requirements, Objectives and Interface, GR-303-CORE, Issue 1, September 1995.

#### **4.4.1.3 Requirements for an Intelligent Loop Concentrator/Multiplexer**

4.4.1.3.1 In addition to the basic functions described above for the Loop Concentrator/Multiplexer, the Intelligent Loop Concentrator/Multiplexer (IC/M) shall

provide facility grooming, facility test functions, format conversion and signaling conversion as appropriate.

4.4.1.3.2 The underlying equipment that provides such IC/M function shall continuously monitor protected circuit packs and redundant common equipment.

4.4.1.3.3 The underlying equipment that provides such IC/M function shall automatically switch to a protection circuit pack on detection of a failure or degradation of normal operation.

4.4.1.3.4 The underlying equipment that provides such IC/M function shall be equipped with a redundant power supply or a battery back-up.

4.4.1.3.5 At MCI's option, BellSouth shall provide MCI with real time performance monitoring and alarm data on IC/M elements that may affect MCI's traffic. This includes IC/M hardware alarm data and facility alarm data on the underlying device that provides such IC/M function.

4.4.1.3.6 At MCI's option, BellSouth shall provide MCI with real time ability to initiate tests on the underlying device that provides such IC/M function integrated test equipment as well as other integrated functionality for routine testing and fault isolation.

#### 4.4.1.4 Interface Requirements

4.4.1.4.1 The Loop Concentrator/Multiplexer shall meet the following interface requirements, as appropriate for the configuration that MCI designates:

4.4.1.4.2 The Loop Concentrator/Multiplexer shall provide an analog voice frequency copper twisted pair interface at the serving wire center, as described in the references in Section 4.4.1.2.4.

4.4.1.4.3 The Loop Concentrator/Multiplexer shall provide digital 4-wire electrical interfaces at the

serving wire center, as described in the references in Section 4.4.1.2.4.

4.4.1.4.4 The Loop Concentrator/Multiplexer shall provide optical SONET interfaces at rates of OC-3, OC-12, OC-48, and OC-N, N as described in the references in Section 4.4.1.2.4.

4.4.1.4.5 The Loop Concentrator/Multiplexer shall provide the Bellcore TR-303 DS1 level interface at the serving wire center. Loop Concentrator/ Multiplexer shall provide Bellcore TR-08 modes 1&2 DS1 interfaces when designated by MCI. Such interface requirements are specified in the references in Section 4.4.1.2.4.

4.4.1.5 The Intelligent Loop Concentrator/Multiplexer shall be provided to MCI in accordance with the Technical References set forth in Sections 4.4.1.2.4.8 through 4.4.1.2.4.11 above.

#### **4.4.2 Loop Feeder**

##### **4.4.2.1 Definition:**

4.4.2.1.1 The Loop Feeder provides connectivity between (1) a Feeder Distribution Interface (FDI) associated with Loop Distribution and a termination point appropriate for the media in a central office, or (2) a Loop Concentrator/Multiplexer provided in a remote terminal and a termination point appropriate for the media in a central office. BellSouth shall provide MCI physical access to the FDI, and the right to connect, the Loop Feeder to the FDI.

4.4.2.1.2 The physical medium of the Loop Feeder may be copper twisted pair, or single or multi-mode fiber or other technologies as designated by MCI. In certain cases, MCI will require a copper twisted pair loop even in instances where the medium of the Loop Feeder for services that BellSouth offers is other than a copper facility.

**4.4.2.2 Requirements for Loop Feeder**

**4.4.2.2.1** The Loop Feeder shall be capable of transmitting analog voice frequency, basic rate ISDN, digital data, or analog radio frequency signals as appropriate.

**4.4.2.2.2** BellSouth shall provide appropriate power for all active elements in the Loop Feeder. BellSouth will provide appropriate power from a central office source, or from a commercial AC source with rectifiers for AC to DC conversion and 8-hour battery back-up when the equipment is located in an outside plant Remote Terminal (RT).

**4.4.2.3 Additional Requirements for Special Copper Loop Feeder Medium**

In addition to requirements set forth in Section 4.2 (above), MCIm may require BellSouth to provide copper twisted pair Loop Feeder which is unfettered by any intervening equipment (e.g. filters, load coils, and range extenders), so that MCIm can use these Loop Feeders for a variety of services by attaching appropriate terminal equipment at the ends.

**4.4.2.4 Additional Technical Requirements for DS1 Conditioned Loop Feeder**

In addition to the requirements set forth in Section 4.4.2.2 above, MCIm may designate that the Loop Feeder be conditioned to transport a DS1 signal. The requirements for such transport are defined in the references below in Section 4.4.2.6.

**4.4.2.5 Additional Technical Requirements for Optical Loop Feeder**

In addition to the requirements set forth in Section 4.4.2.2 above, MCIm may designate that Loop Feeder will transport DS3 and OCn (where n is defined in the technical reference in Section 4.4.1.2.4.4. The requirements for such transport are defined in the references below in Section 4.4.2.6.

**4.4.2.6 BellSouth shall offer Loop Feeder in accordance with the requirements set forth in the following Technical References:**

**4.4.2.6.1 Bellcore Technical Requirement TR-NWT-000499, Issue 5, December 1993, section 7 for DS1 interfaces; and,**

**4.4.2.6.2 Bellcore TR-NWT-000057, Functional Criteria for Digital Loop Carrier Systems, Issue 2, January 1993.**

**4.4.2.6.3 Bellcore TR-NWT-000393, Generic Requirements for ISDN Basic Access Digital Subscriber Lines.**

**4.4.2.6.4 ANSI T1.106-1988, American National Standard for Telecommunications - Digital Hierarchy - Optical Interface Specifications (Single Mode).**

**4.4.2.6.5 ANSI T1.105-1995, American National Standard for Telecommunications - Synchronous Optical Network (SONET) - Basic Description including Multiplex Structure, Rates and Formats.**

**4.4.2.6.6 ANSI T1.102-1993, American National Standard for Telecommunications - Digital Hierarchy - Electrical Interfaces.**

**4.4.2.6.7 ANSI T1.403-1989, American National Standard for Telecommunications - Carrier to Subscriber Installation, DS1 Metallic Interface Specification**

**4.4.2.6.8 Bellcore GR-253-CORE, Synchronous Optical Network Systems (SONET), Common Generic Criteria.**

**4.4.2.7 Interface Requirements**

**4.4.2.7.1 The Loop Feeder point of termination (POT) within a BellSouth central office will be as follows:**



4.4.2.7.1.1 Copper twisted pairs shall terminate on the MDF;

4.4.2.7.1.2 DS1 Loop Feeder shall terminate on a DSX1, DCS1/0 or DCS3/1; and

4.4.2.7.1.3 Fiber Optic cable shall terminate on a LGX.

4.4.2.7.2 Loop Feeder shall be equal to or better than each of the applicable interface requirements set forth in the following technical references:

4.4.2.7.2.1 Bellcore TR-TSY-000008, Digital Interface Between the SLC 96 Digital Loop Carrier System and a Local Digital Switch, Issue 2, August 1987.

4.4.2.7.2.2 Bellcore TR-NWT-000303, Integrated Digital Loop Carrier System Generic Requirements, Objectives and Interface, Issue 2, December 1992- Rev. 1, December 1993-1 Supplement 1, December 1993.

4.4.2.7.2.3 Bellcore Integrated Digital Loop Carrier System Generic Requirements, Objectives and Interface, GR-303-CORE, Issue 1, September 1995.

#### **4.5 Network Interface Device**

##### **4.5.1 Definition:**

4.5.1.1 The Network Interface Device (NID) is a single-line termination device or that portion of a multiple-line termination device required to terminate a single line or circuit. The function of the NID is to establish the network demarcation point between a carrier and its subscriber. The NID features two independent chambers or divisions which separate the service provider's network from the subscriber's inside wiring. Each chamber or division contains the appropriate connection points or posts to which the service provider, and the subscriber each make their connections.

4.5.1.2 With respect to multiple-line termination devices, MCIm shall specify the quantity of NIDs it requires within such device.

4.5.1.3 Figure 1 shows a schematic of a NID.

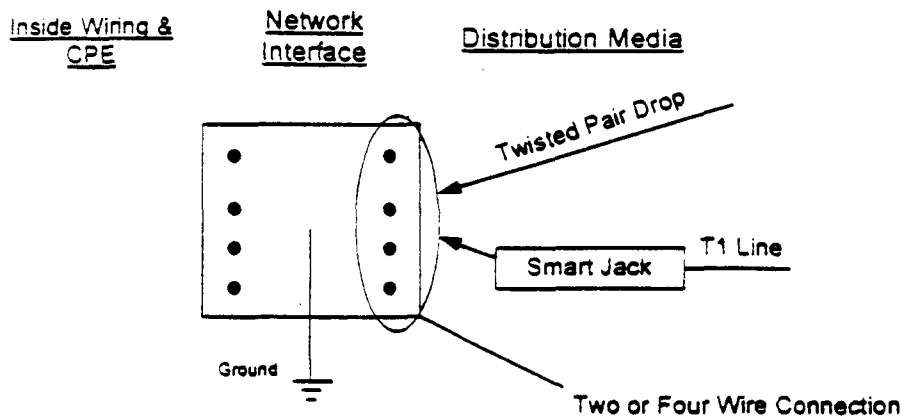

Figure 1 - Network Interface Device

#### 4.5.2 Technical Requirements

4.5.2.1 The BellSouth Network Interface Device shall provide a clean, accessible point of connection for the inside wiring for MCIm's Distribution Media via MCIm's NID and shall maintain a connection to ground that meets the requirements set forth below.

4.5.2.2 The NID shall be capable of transferring electrical analog or digital signals between the subscriber's inside wiring for MCIm's Distribution Media via MCIm's NID.

4.5.2.3 All NID posts or connecting points shall be in place, secure, usable and free of any rust or corrosion. The protective ground connection shall exist and be properly installed. The ground wire shall be free of rust or corrosion and have continuity relative to ground.

4.5.2.4 The NID shall be capable of withstanding all normal local environmental variations.

4.5.2.5 Where the NID is not located in a larger, secure cabinet or closet, the NID shall be protected from physical vandalism. The NID shall be physically accessible to MCIm designated personnel. In cases where entrance to the subscriber premises is required to give access to the NID, MCIm shall obtain entrance permission directly from the subscriber.

4.5.2.6 BellSouth shall offer the NID together with, and separately from the Distribution Media component of Loop Distribution.

#### 4.5.3 Interface Requirements

4.5.3.1 The NID shall be the interface to subscribers' premises wiring for all loop technologies.

4.5.3.2 The NID shall be equal to or better than all of the industry standards for NIDs set forth in the following technical references:

4.5.3.2.1 Bellcore Technical Advisory TA-TSY-000120 "Subscriber Premises or Network Ground Wire";

4.5.3.2.2 Bellcore Generic Requirement GR-49-CORE "Generic Requirements for Outdoor Telephone Network Interface Devices";

4.5.3.2.3 Bellcore Technical Requirement TR-NWT-00239 "Indoor Telephone Network Interfaces";

4.5.3.2.4 Bellcore Technical Requirement TR-NWT-000937 "Generic Requirements for Outdoor and Indoor Building Entrance"; and,

4.5.3.2.5 Bellcore Technical Requirement TR-NWT-0001 3 "Generic Requirements for Network Inside Wiring."

**4.5.4 Responsibilities of The Parties for Conditions of Access And Attachment To NIDs.** BellSouth shall allow MCIm to directly connect MCIm's Distribution Media to a BellSouth NID by using excess capacity on the NID. Where no excess capacity exists, MCIm shall adhere to the FCC rules regarding a NID-to-NID arrangement until such time as the appropriate guidelines are developed and incorporated within the National Electric Safety Code.

**4.6. Distribution -**

**4.6.1 Definition:**

**4.6.1.1 Distribution is a Network Element which provides connectivity between the NID component of Loop Distribution and the terminal block on the subscriber-side of a Feeder Distribution Interface (FDI). The FDI is a device that terminates the Distribution Media and the Loop Feeder, and cross-connects them in order to provide a continuous transmission path between the NID and a telephone company central office. There are three basic types of feeder-distribution connection: (i) multiple (splicing of multiple distribution pairs onto one feeder pair); (ii) dedicated ("home run"); and (iii) interfaced ("cross-connected"). While older plant uses multiple and dedicated approaches, newer plant and all plant that uses DLC or other pair-gain technology necessarily uses the interfaced approach. The feeder-distribution interface (FDI) in the interfaced design makes use of a manual cross-connection, typically housed inside an outside plant device ("green box") or in a vault or manhole.**

**4.6.1.2 The Distribution may be copper twisted pair, coax cable, single or multi-mode fiber optic cable or other technologies. A combination that includes two or more of these media is also possible. In certain cases, MCIm shall require a copper twisted pair Distribution even in instances where the Distribution for services that BellSouth offers is other than a copper facility.**

**4.6.2 Requirements for All Distribution**

**4.6.2.1 Distribution shall be capable of transmitting signals for the following services (as requested by MCIm):**

4.6.2.1.1 Two-wire & four-wire analog voice grade loops;

4.6.2.1.2 Two-wire & four-wire loops that are conditioned to transmit the digital signals needed to provide services such as ISDN, ADSL, HDSL, and DS1-level signals.

4.6.2.2 Distribution shall transmit all signaling messages or tones. Where the Distribution includes any active elements that terminate any of the signaling messages or tones, these messages or tones shall be reproduced by the Distribution at the interfaces to an adjacent Network Element in a format that maintains the integrity of the signaling messages or tones.

4.6.2.3 Distribution shall support functions associated with provisioning, maintenance and testing of the Distribution itself, as well as provide necessary access to provisioning, maintenance and testing functions for Network Elements to which it is associated.

4.6.2.4 Where possible, Distribution shall provide performance monitoring of the Distribution itself, as well as provide necessary access for performance monitoring for Network Elements to which it is associated.

4.6.2.5 Distribution shall be equal to or better than all of the applicable requirements set forth in the following technical references:

4.6.2.5.1 Bellcore TR-TSY-000057, "Functional Criteria for Digital Loop Carrier Systems", and,

4.6.2.5.2 Bellcore TR-NWT-000393, "Generic Requirements for ISDN Basic Access Digital Subscriber Lines."

4.6.2.6 BellSouth shall provide MCI with physical access to, and the right to connect to, the FDI.

4.6.2.7 BellSouth shall offer Distribution together with, and separately from the NID component of Loop Distribution.

4.6.3 Additional Requirements for Special Copper Distribution

In addition to Distribution that supports the requirements in Section 6.2. (above), MCI may designate Distribution to be copper twisted pair which are unfettered by any intervening equipment (e.g., filters, load coils, range extenders) so that MCI can use these loops for a variety of services by attaching appropriate terminal equipment at the ends.

#### **4.6.4 Additional Requirements for Fiber Distribution**

Fiber optic cable Distribution shall be capable of transmitting signals for the following services in addition to the ones under Section 6.2.1 above:

**4.6.4.1 DS3 rate private line service;**

**4.6.4.2 Optical SONET OCn rate private lines (where n is defined in the technical reference in Section 4.4.1.2.4.4; and**

**4.6.4.3 Analog Radio Frequency based services (e.g., Cable Television (CATV)).**

#### **4.6.5 Additional Requirements for Coaxial Cable Distribution**

Coaxial Cable (coax) Distribution shall be capable of transmitting signals for the following services in addition to the ones under Section 6.2.1 above:

**4.6.5.1 Broadband data, either one way or bi-directional, symmetric or asymmetric, at rates between 1.5 Mb/s and 45 Mb/s; and**

**4.6.5.2 Analog Radio Frequency based services (e.g., CATV).**

#### **4.6.6 Interface Requirements**

**4.6.6.1 Signal transfers between the Distribution and the NID and an adjacent Network Element shall have levels of degradation that are within the performance requirements set forth in Section 15.2 of this Attachment III.**

**4.6.6.2 Distribution shall be equal to or better than each of the applicable interface requirements set forth in the following technical references:**

4.6.6.2.1 Bellcore TR-NWT-000049, "Generic Requirements for Outdoor Telephone Network Interface Devices," Issued December 1, 1994;

4.6.6.2.2 Bellcore TR-NWT-000057, "Functional Criteria for Digital Loop Carrier Systems," Issued January 2, 1993;

4.6.6.2.3 Bellcore TR-NWT-000393, "Generic Requirements for ISDN Basic Access Digital Subscriber Lines";

4.6.6.2.4 Bellcore TR-NWT-000253, SONET Transport Systems: Common Criteria (A module of TSGR, FR-NWT-000440), Issue 2, December 1991;

***Section 5 Left Blank Intentionally***

***Section 6 Left Blank Intentionally***

***Section 7. Local Switching***

**7.1 Definition:**

**7.1.1 Local Switching is the Network Element that provides the functionality required to connect the appropriate lines or trunks wired to the Main Distributing Frame (MDF) or Digital Cross Connect (DSX) panel to a desired line or trunk. The desired connection path for each call type will vary by subscriber and will be specified by MCIm as a routing scenario that will be implemented in advance as part of or after the purchases of the unbundled local switching. Such functionality shall include all of the features, functions, and capabilities that the underlying BellSouth switch that is providing such Local Switching function is capable of providing, including but not limited to: line signaling and signaling software, digit reception, dialed number translations, call screening, routing, recording, call supervision, dial tone, switching, telephone number provisioning, announcements, calling features and capabilities (including call processing), Centrex, or Centrex-like services, Automatic Call Distributor (ACD), Carrier pre-subscription (e.g., long distance carrier, intraLATA toll), Carrier Identification Code (CIC) portability capabilities, testing and other operational features inherent to the switch and switch software. It also**

## **MCImetro-BellSouth Florida Interconnection Agreement**

provides access to transport, signaling (ISDN User Part (ISUP) and Transaction Capabilities Application Part (TCAP), and platforms such as adjuncts, Public Safety Systems (911), operator services, directory services and Advanced Intelligent Network (AIN). Remote Switching Module functionality is included in the Local Switching function. Local Switching shall also be capable of routing local, intraLATA, interLATA, calls to international subscriber's preferred carrier, call features (e.g., call forwarding) and Centrex capabilities.

**7.1.2 Local Switching, including the ability to route to MCIm's transport facilities, dedicated facilities and systems, shall be unbundled from all other unbundled Network Elements, i.e., Operator Systems, Common Transport, and Dedicated Transport. BellSouth shall provide MCIm with selective routing via Line Class Codes on a first-come, first-served basis. Further, MCIm and BellSouth shall continue to work with the appropriate industry groups to develop a long term solution for selective routing. BellSouth may reserve for itself a reasonable number of line class codes.**

### **7.2. Technical Requirements**

**7.2.1 Local Switching shall be equal to or better than the requirements for Local Switching set forth in Bellcore's Local Switching Systems General Requirements (FR-NWT-000064).**

**7.2.1.1 BellSouth shall route calls to the appropriate trunk or lines for call origination or termination.**

**7.2.1.2 Subject to section 7.1.2, above, BellSouth shall route calls on a per line or per screening class basis to (1) BellSouth platforms providing Network Elements or additional requirements, (2) MCIm designated platforms, or (3) third party platforms.**

**7.2.1.3 Subject to section 7.1.2, above, BellSouth shall provide recorded announcements as designated by MCIm and call progress tones to alert callers of call progress and disposition. If BellSouth cannot provide branded messages upon MCIm's request, BellSouth will remove it's own branding from all such announcements.**

**7.2.1.4 BellSouth shall change a subscriber from BellSouth's services to MCIm's services without loss of**



feature functionality, unless expressly agreed otherwise by MCIm.

7.2.1.5 BellSouth shall perform routine testing (e.g., Mechanized Loop Tests (MLT) and test calls such as 105, 107 and 108 type calls) and fault isolation on a schedule designated by MCIm.

7.2.1.6 BellSouth shall repair and restore any equipment or any other maintainable component that may adversely impact MCIm's use of unbundled Local Switching.

7.2.1.7 BellSouth shall control congestion points such as mass calling events, and network routing abnormalities, using capabilities such as Automatic Call Gapping, Automatic Congestion Control (e.g. choke trunk groups), and Network Routing Overflow. Application of such control shall be competitively neutral and not favor any user of unbundled switching or BellSouth.

7.2.1.8 BellSouth shall perform manual call trace as designated by MCIm and permit subscriber originated call trace.

7.2.1.9 BellSouth shall record all billable events, involving usage of the element, and send the appropriate recording data to MCIm as outlined in Attachment VIII.

7.2.1.10 For Local Switching used as 911 Tandems, BellSouth shall allow interconnection from MCIm local switching elements and BellSouth shall route the calls to the appropriate Public Safety Access Point (PSAP).

7.2.1.11 Where BellSouth provides the following special services, it shall provide to MCIm:

7.2.1.11.1 Essential Service Lines;

7.2.1.11.2 Telephone Service Prioritization;

7.2.1.11.3 Related services for handicapped;

7.2.1.11.4 Soft dial tone where required by law. Where BellSouth provides soft dial tone, it shall do so on a competitively-neutral basis.

7.2.1.11.5 Any other service required by law or regulation.

7.2.1.12 BellSouth shall provide Switching Service Point (SSP) capabilities and signaling software to interconnect the signaling links destined to the Signaling Transfer Point Switch (STPs). In the event that Local Switching is provided out of a switch without SS7 capability, the Tandem shall provide this capability as discussed in the section on Tandem Switching. These capabilities shall adhere to Bellcore specifications TCAP (GR-1432-CORE), ISUP (GR-905-CORE), Call Management (GR-1429-CORE), Switched Fractional DS1 (GR-1357-CORE), Toll Free Service (GR-1428-CORE), Calling Name (GR-1597-CORE), Line Information Database (GR-954-CORE), and Advanced Intelligent Network (GR-2863-CORE).

7.2.1.13 BellSouth shall provide interfaces to adjuncts through industry standard and Bellcore interfaces. These adjuncts can include, but are not limited to, Service Node, Service Circuit Node, Voice Mail and Automatic Call Distributors. Examples of existing interfaces are ANSI ISDN standards Q.931 and Q.932.

7.2.1.14 BellSouth shall provide performance data regarding a subscriber line, traffic characteristics or other measurable elements to MCIm, upon MCIm's request.

7.2.1.15 BellSouth shall offer all Local Switching features that are Technically Feasible and provide feature offerings at parity to those provided by BellSouth to itself or any other party. Such feature offerings shall include but are not limited to:

7.2.1.15.1 Basic and primary rate ISDN;

7.2.1.15.2 Residential features;

7.2.1.15.3 Custom Local Area Signaling Services (CLASS/LASS);

7.2.1.15.4 Custom Calling Features

**MCImetro-BellSouth Florida Interconnection Agreement**

**7.2.1.15.5 Centrex (including equivalent administrative capabilities, such as subscriber accessible reconfiguration and detailed message recording); and**

**7.2.1.15.6 Advanced intelligent network triggers supporting MCIm, and BellSouth service applications, in BellSouth's SCPs. BellSouth shall offer to MCIm all AIN triggers currently available to BellSouth for offering AIN-based services in accordance with applicable Bellcore technical references:**

**7.2.1.15.6.1 Off-Hook Immediate;**

**7.2.1.15.6.2 Off-Hook Delay;**

**7.2.1.15.6.3 Termination Attempt;**

**7.2.1.15.6.4 3/6/10;**

**7.2.1.15.6.5 Feature Code Dialing;**

**7.2.1.15.6.6 Custom Dialing Plan(s) including 555 services; and**

**7.2.1.15.7 When the following triggers are supported by BellSouth, BellSouth shall make said triggers available to MCIm:**

**7.2.1.15.7.1 Private EAMF Trunk;**

**7.2.1.15.7.2 Shared Interoffice Trunk (EAMF, SS7);**

**7.2.1.15.7.3 N11;**

**7.2.1.15.7.4 Automatic Route Selection.**

**7.2.1.16 Subject to section 7.1.2, above, BellSouth shall assign each MCIm subscriber line the class of service designated by MCIm using line class codes, and shall route directory assistance calls from MCIm subscribers as directed by MCIm at MCIm's option. This includes each of the following call types:**

7.2.1.16.1 O+/O- calls

7.2.1.16.2 911 calls

7.2.1.16.3 411/DA calls

7.2.1.16.4 InterLATA calls specific to PIC or regardless of PIC

7.2.1.16.5 IntraLATA calls specific to PIC or regardless of PIC

7.2.1.16.6 800/888 calls, prior to database query

7.1.2.16.7 Call forwarding of any type supported on the switch, to a line or a trunk

7.1.2.16.8 Any other customized routing that may be supported by the BellSouth switch

**7.2.1.17 Subject to section 7.1.2, above, BellSouth shall assign each MCI subscriber line the class of services designated by MCI using line class codes and shall route operator calls from MCI subscribers as directed by MCI at MCI's option. For example, BellSouth may translate 0- and 0+ intraLATA traffic, and route the call through appropriate trunks to an MCI Operator Services Position System (OSPS). Calls from Local Switching must pass the ANI-II digits unchanged.**

**7.2.1.18 If an MCI subscriber subscribes to MCI provided voice mail and messaging services, BellSouth shall redirect incoming calls to the MCI system based upon presubscribed service arrangements (e.g., busy, don't answer, number of rings). In addition, BellSouth shall provide a Standard Message Desk Interface-Enhanced (SMDI-E) interface to the MCI system. BellSouth shall support the Inter-switch Voice Messaging Service (IVMS) capability.**

**7.2.1.19 Local Switching shall be offered in accordance with the requirements of the following technical references and their future releases:**

**MCI metro-BellSouth Florida Interconnection Agreement**

**7.2.1.19.1 GR-1298-CORE, AIN Switching System Generic Requirements;**

**7.2.1.19.2 GR-1299-CORE, AIN Switch-Service Control Point (SCP)/Adjunct Interface Generic Requirements;**

**7.2.1.19.3 TR-NWT-001284, AIN 0.1 Switching System Generic Requirements;**

**7.2.1.19.4 SR-NWT-002247, AIN Release 1 Update.**

**7.2.2 Interface Requirements:**

**7.2.2.1 BellSouth shall provide the following interfaces to loops:**

**7.2.2.1.1 Standard Tip/Ring interface including loopstart or groundstart, on-hook signaling (e.g., for calling number, calling name and message waiting lamp);**

**7.2.2.1.2 Coin phone signaling;**

**7.2.2.1.3 Basic Rate Interface ISDN adhering to ANSI standards Q.931, Q.932 and appropriate Bellcore Technical Requirements;**

**7.2.2.1.4 Two-wire analog interface to PBX to include reverse battery, E&M, wink start and DID;**

**7.2.2.1.5 Four-wire analog interface to PBX to include reverse battery, E&M, wink start and DID;**

**7.2.2.1.6 Four-wire DS1 interface to PBX or subscriber provided equipment (e.g., computers and voice response systems);**

**7.2.2.1.7 Primary Rate ISDN to PBX adhering to ANSI standards Q.931, Q.932 and appropriate Bellcore Technical Requirements;**

**7.2.2.1.8 Switched Fractional DS1 with capabilities to configure Nx64 channels (where N = 1 to 24); and**

## MCImetro-BellSouth Florida Interconnection Agreement

7.2.2.1.9 Loops adhering to Bellcore TR-NWT-08 and TR-NWT-303 specifications to interconnect Digital Loop Carriers.

7.2.2.2 BellSouth shall provide access to the following but not limited to:

7.2.2.2.1 SS7 Signaling Network or Multi-Frequency trunking if requested by MCI;

7.2.2.2.2 Subject to section 7.1.2, above, interface to MCI operator services systems or Operator Services through appropriate trunk interconnections for the system; and

7.2.2.2.3 Subject to section 7.1.2, above, interface to MCI directory assistance services through the MCI switched network or to Directory Services through the appropriate trunk interconnections for the system; and 950 access or other MCI required access to interexchange carriers as requested through appropriate trunk interfaces.

### 7.3 Integrated Services Digital Network (ISDN)

7.3.1 Integrated Services Digital Network (ISDN) is defined in two variations. The first variation is Basic Rate ISDN (BRI). BRI consists of 2 Bearer (B) Channels and one Data (D) Channel. The second variation is Primary Rate ISDN (PRI). PRI consists of 23 B Channels and one D Channel. Both BRI and PRI B Channels may be used for voice, Circuit Switched Data (CSD) or Packet Switched Data (PSD). The BRI D Channel may be used for call related signaling, non-call related signaling or packet switched data. The PRI D Channel may be used for call related signaling.

#### 7.3.2 Technical Requirements — ISDN

7.3.2.1 BellSouth shall offer Data Switching providing ISDN that, at a minimum:

7.3.2.2 Provide integrated Packet handling capabilities;

7.3.2.3 Allow for full 2B+D Channel functionality for BRI; and

7.3.2.4 Allow for full 23B+D Channel functionality for PRI.

7.3.2.5 Each B Channel shall allow for voice, 64 Kbps CSD, and PSD of 128 logical channels at minimum speeds of 19 Kbps throughput of each logical channel up to the total capacity of the B Channel.

7.3.2.6 Each B Channel shall provide capabilities for alternate voice and data on a per call basis.

7.3.2.7 The BRI D Channel shall allow for call associated signaling, non-call associated signaling and PSD of 16 logical channels at minimum speeds of 9.6 Kbps throughput of each logical channel up to the total capacity of the D channel.

7.3.2.8 The PRI D Channel shall allow for call associated signaling.

### 7.3.3 Interface Requirements — ISDN

7.3.3.1 BellSouth shall provide the BRI U interface using 2-wire copper loops in accordance with TR-NWT-000393, January 1991, Generic Requirements for ISDN Basic Access Digital Subscriber Lines.

7.3.3.2 BellSouth shall provide the BRI interface using Digital Subscriber Loops adhering to Bellcore TR-NWT-303 specifications to interconnect Digital Loop Carriers.

7.3.3.3 BellSouth shall offer PSD interfaces adhering to the X.25, X.75 and X.75' ANSI and Bellcore requirements.

7.3.3.4 BellSouth shall offer PSD trunk interfaces operating at 56 Kbps.

## **Section 8. Operator Systems**

See Attachment VIII, Section 6.1.2 Directory Assistance Service and 5.1.3 Operator Service.

## **Section 9. Common Transport**

### 9.1 Definition:

Common Transport is an interoffice transmission path between BellSouth Network Elements (illustrated in Figure 2) shared by carriers. Where BellSouth Network Elements are connected by intra-office wiring, such wiring is provided as a part of the Network Elements and is not Common Transport. BellSouth shall offer Common Transport as of the effective date of the agreement, at DS0, DS1, DS3, STS-1 or higher transmission bit rate circuits. Common Transport consists of BellSouth inter-office transport facilities and is distinct and separate from local switching.

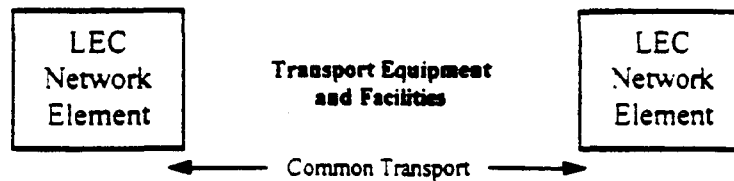

Figure 2

## 9.2 Technical Requirements

9.2.1 BellSouth shall be responsible for the engineering, provisioning, and maintenance of the underlying equipment and facilities that are used to provide Common Transport.

9.2.2 At a minimum, Common Transport shall meet all of the requirements set forth in the following technical references (as applicable for the transport technology being used):

9.2.3. ANSI T1.101-1994, American National Standard for Telecommunications - Synchronization Interface Standard Performance and Availability;

9.2.3.1 ANSI T1.102-1993, American National Standard for Telecommunications - Digital Hierarchy - Electrical Interfaces;

9.2.3.2 ANSI T1.102.01-199x, American National Standard for Telecommunications - Digital Hierarchy - VT1.5;

9.2.3.3 ANSI T1.105-1995, American National Standard for Telecommunications - Synchronous Optical Network (SONET) - Basic Description including Multiplex Structure, Rates and Formats;



9.2.3.4 ANSI T1.105.01-1995, American National Standard for Telecommunications - Synchronous Optical Network (SONET) Automatic Protection Switching;

9.2.3.5 ANSI T1.105.02-1995, American National Standard for Telecommunications - Synchronous Optical Network (SONET) - Payload Mappings;

9.2.3.6 ANSI T1.105.03-1994, American National Standard for Telecommunications - Synchronous Optical Network (SONET) - Jitter at Network Interfaces;

9.2.3.7 ANSI T1.105.03a-1995, American National Standard for Telecommunications - Synchronous Optical Network (SONET)-Jitter at Network Interfaces - DS1 Supplement;

9.2.3.8 ANSI T1.105.05-1994, American National Standard for Telecommunications - Synchronous Optical Network (SONET) - Tandem Connection;

9.2.3.9 ANSI T1.105.06-199x, American National Standard for Telecommunications - Synchronous Optical Network (SONET) - Physical Layer Specifications;

9.2.3.10 ANSI T1.105.07-199x, American National Standard for Telecommunications - Synchronous Optical Network (SONET) - Sub STS-1 Interface Rates and Formats;

9.2.3.11 ANSI T1.105.09-199x, American National Standard for Telecommunications - Synchronous Optical Network (SONET) - Network Element Timing and Synchronization;

9.2.3.12 ANSI T1.106-1988, American National Standard for Telecommunications - Digital Hierarchy - Optical Interface Specifications (Single Mode);

9.2.3.13 ANSI T1.107-1988, American National Standard for Telecommunications - Digital Hierarchy - Formats Specifications;

9.2.3.14 ANSI T1.107a-1990 -American National Standard for Telecommunications - Digital Hierarchy - Supplement to Formats Specifications (DS3 Format Applications);

9.2.3.15 ANSI T1.107b-1991 -American National Standard for Telecommunications - Digital Hierarchy - Supplement to Formats Specifications;

9.2.3.16 ANSI T1.117-1991, American National Standard for Telecommunications - Digital Hierarchy - Optical Interface Specifications (SONET) (Single Mode - Short Reach);

9.2.3.17 ANSI T1.403-1989, Carrier to Subscriber Installation, DS1 Metallic Interface Specification;

9.2.3.18 ANSI T1.404-1994, Network-to-Subscriber Installation - DS3 Metallic Interface Specification;

9.2.3.19 ITU Recommendation G.707, Network node interface for the synchronous digital hierarchy (SDH);

9.2.3.20 ITU Recommendation G.704, Synchronous frame structures used at 1544, 6312, 2048, 8488 and 44736 kbit/s hierarchical levels;

9.2.3.21 Bellcore FR-440 and TR-NWT-000499, Transport Systems Generic Requirements (TSGR): Common Requirements;

9.2.3.22 Bellcore GR-820-CORE, Generic Transmission Surveillance: DS1 & DS3 Performance;

9.2.3.23 Bellcore GR-253-CORE, Synchronous Optical Network Systems (SONET); Common Generic Criteria;

9.2.3.24 Bellcore TR-NWT 000507, Transmission, Section 7, Issue 5 (Bellcore, December 1993). (A module of LSSGR, FR-NWT-000064.);

9.2.3.25 Bellcore TR-NWT-000776, Network Interface Description for ISDN Subscriber Access;

9.2.3.26 Bellcore TR-INS-000342, High-Capacity Digital Special Access Service-Transmission Parameter Limits and Interface Combinations, Issue 1 February 1991;

9.2.3.27 Bellcore ST-TEC-000052, Telecommunications Transmission Engineering Textbook, Volume 2: Facilities, Third Edition, Issue I May 1989;

9.2.3.28 Bellcore ST-TEC-000051, Telecommunications Transmission Engineering Textbook Volume 1: Principles, Third Edition. Issue 1 August 1987;

## **Section 10. Dedicated Transport**

### **10.1 Definition**

10.1.1 Dedicated Transport is an interoffice transmission path between MCI designated locations to which MCI is granted exclusive use. Such locations may include BellSouth central offices or other locations, MCI network components, other carrier network components, or subscriber premises. Dedicated Transport is depicted below in Figure 3.



**Figure 3**

10.1.2 BellSouth shall offer Dedicated Transport in each of the following manners:

10.1.2.1 As capacity on a shared facility.

10.1.2.2 As a circuit (e.g., DS1, DS3, STS-1) dedicated to MCI.

10.1.2.3 As a system (i.e., the equipment and facilities used to provide Dedicated Transport such as SONET ring) dedicated to MCI.

10.1.3 When Dedicated Transport is provided as a circuit or as capacity on a shared facility, it shall include (as appropriate):

10.1.3.1 Multiplexing functionality;

10.1.3.2 Grooming functionality; and,

10.1.3.3 Redundant equipment and facilities necessary to support protection and restoration.

10.1.4 When Dedicated Transport is provided as a system it shall include:

10.1.4.1 Transmission equipment such as multiplexers, line terminating equipment, amplifiers, and regenerators;

10.1.4.2 Inter-office transmission facilities such as optical fiber, copper twisted pair, and coaxial cable;

10.1.4.3 Redundant equipment and facilities necessary to support protection and restoration; and,

10.1.4.4 Dedicated Transport includes the Digital Cross-Connect System (DCS) functionality as an option. DCS is described below in Section 10.5.

## 10.2 Technical Requirements -

This Section sets forth technical requirements for all Dedicated Transport.

10.2.1 When BellSouth provides Dedicated Transport as a circuit or a system, the entire designated transmission circuit or system (e.g., DS1, DS3, STS-1) shall be dedicated to MCIm designated traffic.

10.2.2 BellSouth shall offer Dedicated Transport using currently available technologies including, but not limited to, DS1 and DS3 transport systems, SONET (or SDH) Bi-directional Line Switched Rings, SONET (or SDH) Unidirectional Path Switched Rings, and SONET (or SDH) point-to-point transport systems (including linear add-drop systems), at all available transmission bit rates.

10.2.3 When requested by MCIm, Dedicated Transport shall provide physical diversity. Physical diversity means that two circuits are provisioned in such a way that no single failure of facilities or equipment will cause a failure on both circuits.

10.2.4 When physical diversity is requested by MCIm, BellSouth shall provide the maximum feasible physical separation between

**MCImetro-BellSouth Florida Interconnection Agreement**

transmission paths for all facilities and equipment (unless otherwise agreed by MCIm).

10.2.5 Upon MCIm's request, BellSouth shall provide real time and continuous remote access to performance monitoring and alarm data affecting, or potentially affecting, MCIm's traffic.

10.2.6 BellSouth shall offer the following interface transmission rates for Dedicated Transport:

10.2.6.1 DS1 (Extended SuperFrame - ESF/B8ZS, D4, and unframed applications shall be provided);

10.2.6.2 DS3 (C-bit Parity, M13, and unframed applications shall be provided);

10.2.6.3 SONET standard interface rates in accordance with ANSI T1.105 and ANSI T1.105.07 and physical interfaces per ANSI T1.106.06 (including referenced interfaces). In particular, VT1.5 based STS-1s will be the interface at an MCIm service node.

10.2.6.4 SDH Standard interface rates in accordance with International Telecommunications Union (ITU) Recommendation G.707 and Plesiochronous Digital Hierarchy (PDH) rates per ITU Recommendation G.704.

10.2.7 BellSouth shall provide cross-office wiring up to a suitable Point of Termination (POT) between Dedicated Transport and MCIm designated equipment. BellSouth shall provide the following equipment for the physical POT:

10.2.7.1 DSX1 for DS1s or VT1.5s;

10.2.7.2 DSX3 for DS3s or STS-1s; and

10.2.7.3 LGX for optical signals (e.g., OC-3 and OC-12).

10.2.9 For Dedicated Transport provided as a system, BellSouth shall design the system (including but not limited to facility routing and termination points) according to MCIm specifications where the MCIm specifications are available. Those MCIm specifications not available shall be addressed via the bona fide request process.

**MCImetro-BellSouth Florida Interconnection Agreement**

**10.2.10** Upon MCI's request, BellSouth shall provide MCI with electronic provisioning control of an MCI specified Dedicated Transport on SONET rings. As system development allows, either initiated by BellSouth or via the bona fide request process, BellSouth shall provide electronic provisioning control of linear transport systems.

**10.2.11** BellSouth shall offer Dedicated Transport together with and separately from DCS.

**10.3 Technical Requirements for Dedicated Transport Using SONET Technology.**

This Section sets forth additional technical requirements for Dedicated Transport using SONET technology including rings, point-to-point systems, and linear add-drop systems.

**10.3.1** All SONET Dedicated Transport provided as a system shall:

**10.3.1.1** Be synchronized from both a primary and secondary Stratum 1 level timing source.

**10.3.1.2** Provide SONET standard interfaces which properly interwork with SONET standard equipment from other vendors. This includes, but is not limited to, SONET standard Section, Line and Path performance monitoring, maintenance signals, alarms, and data channels.

**10.3.1.3** Provide Data Communications Channel (DCC) or equivalent connectivity through the SONET transport system. Dedicated Transport provided over a SONET transport system shall be capable of routing DCC messages between MCI and SONET network components connected to the Dedicated Transport. For example, if MCI leases a SONET ring from BellSouth, that ring shall support DCC message routing between MCI and SONET network components connected to the ring.

**10.3.1.4** Support the following performance requirements for each circuit (STS-1, DS1, DS3, etc.):

**10.3.1.4.1** No more than 10 Errored Seconds Per Day (Errored Seconds are defined in the technical reference at Section 10.4.5); and

10.3.1.4.2 No more than 1 Severely Errored Second Per Day (Severely Errored Seconds are defined in the technical reference at Section 10.4.5).

10.3.2 SONET rings shall:

10.3.2.1 Be provisioned on physically diverse fiber optic cables (including separate building entrances where available and diversely routed intraoffice wiring). "Diversely routed" shall be interpreted as the maximum feasible physical separation between transmission paths, unless otherwise agreed by MCIm.

10.3.2.2 Support dual ring interworking per SONET Standards.

10.3.2.3 Where Technically Feasible, provide the necessary redundancy in optics, electronics, and transmission paths (including intra-office wiring) such that no single failure will cause a service interruption.

10.3.2.4 Provide the ability to disable ring protection switching at MCIm's direction (selective protection lock-out). This requirement applies to line switched rings only. The only exceptions to this requirement shall be BellSouth SONET equipment in use as of the Effective Date which lacks that functionality.

10.3.2.5 Provide the ability to use the protection channels to carry traffic (extra traffic). This requirement applies to line switched rings only. The only exceptions to this requirement shall be BellSouth SONET equipment in use as of the Effective Date which lacks that functionality.

10.3.2.6 Provide 50 millisecond restoration unless a ring protection delay is set to accommodate dual ring interworking schemes.

10.3.2.7 Have settable ring protection switching thresholds that shall be set in accordance with MCIm's specifications.

10.3.2.8 Provide revertive protection switching with a settable wait to restore delay with a default setting of 5 minutes. This requirement applies to line switched rings only.

**MCImetro-BellSouth Florida Interconnection Agreement**

**10.3.2.9 Provide non-revertive protection switching. This requirement applies to path switched rings only.**

**10.3.2.10 Adhere to the following availability requirements, where availability is defined in the technical reference set forth in Section 10.4.5.**

**10.3.2.10.1 No more than 0.25 minutes of unavailability month; and**

**10.3.2.10.2 No more than 0.5 minutes of unavailability per year.**

**10.4 At a minimum, Dedicated Transport shall meet each of the requirements set forth in Section 9.2.3 and in the following technical references.**

**10.4.1 ANSI T1.105.04-1995, American National Standard for Telecommunications - Synchronous Optical Network (SONET) - Data Communication Channel Protocols and Architectures;**

**10.4.2 ANSI T1.119-1994, American National Standard for Telecommunications - Synchronous Optical Network (SONET) - Operations, Administration, Maintenance, and Provisioning (OAM&P) Communications;**

**10.4.3 ANSI T1.119.01-1995, American National Standard for Telecommunications - Synchronous Optical Network (SONET) Operations, Administration, Maintenance, and Provisioning (OAM&P) Communications Protection Switching Fragment;**

**10.4.4 ANSI T1.119.02-199x, American National Standard for Telecommunications - Synchronous Optical Network (SONET) Operations, Administration, Maintenance, and Provisioning (OAM&P) Communications Performance Monitoring Fragment;**

**10.4.5 ANSI T1.231-1993 -American National Standard for Telecommunications - Digital Hierarchy - Layer 1 In-Service Digital Transmission Performance Monitoring.**

**10.5 Digital Cross-Connect System (DCS)**

**10.5.1 Definition:**



10.5.1.1 DCS provides automated cross connection of Digital Signal level 0 (DS0) or higher transmission bit rate digital channels within physical interface facilities. Types of DCSs include but are not limited to DCS 1/0s, DCS 3/1s, and DCS 3/3s, where the nomenclature 1/0 denotes interfaces typically at the DS1 rate or greater with cross-connection typically at the DS0 rate. This same nomenclature, at the appropriate rate substitution, extends to the other types of DCSs specifically cited as 3/1 and 3/3. Types of DCSs that cross-connect Synchronous Transport Signal level 1 (STS-1 s) or other Synchronous Optical Network (SONET) signals (e.g., STS-3) are also DCSs, although not denoted by this same type of nomenclature. DCS may provide the functionality of more than one of the aforementioned DCS types (e.g., DCS 3/3/1 which combines functionality of DCS 3/3 and DCS 3/1). For such DCSs, the requirements will be, at least, the aggregation of requirements on the "component" DCSs.

10.5.1.2 In locations where automated cross connection capability does not exist, DCS will be defined as the combination of the functionality provided by a Digital Signal Cross-Connect (DSX) or Light Guide Cross-Connect (LGX) patch panels and D4 channel banks or other DS0 and above multiplexing equipment used to provide the function of a manual cross connection.

10.5.1.3 Interconnection between a DSX or LGX, to a switch, another cross-connect, or other service platform device, is included as part of DCS.

## 10.6 DCS Technical Requirements

10.6.1 DCS shall provide completed end-to-end cross connection of the channels designated by MCIm.

10.6.2 Where Technically Feasible, DCS shall perform facility grooming, multipoint bridging, one-way broadcast, two-way broadcast, and facility test functions.

10.6.3 DCS shall provide multiplexing, format conversion, signaling conversion, or other functions.

10.6.4 The end-to-end cross connection assignment shall be input to the underlying device used to provide DCS from an operator at a

**MCImetro-BellSouth Florida Interconnection Agreement**

terminal or via an intermediate system. The cross connection assignment shall remain in effect whether or not the circuit is in use.

**10.6.5 BellSouth shall continue to administer and maintain DCS, including updates to the control software to current available releases.**

**10.6.6 BellSouth shall provide various types of Digital Cross-Connect Systems including:**

**10.6.6.1 DS0 cross-connects (typically termed DCS 1/0);**

**10.6.6.2 DS1/VT1.5 (Virtual Tributaries at the 1.5Mbps rate) cross-connects (typically termed DCS 3/1);**

**10.6.6.3 DS3 cross-connects (typically termed DCS 3/3);**

**10.6.6.4 STS-1 cross-connects; and**

**10.6.6.5 Other Technically Feasible cross-connects designated by MCIm.**

**10.6.7 BellSouth shall provide an automated interface which allows real time configuration and reconfiguration of the channels between the physical interfaces.**

**10.6.8 Left Blank Intentionally.**

**10.6.9 DCS shall continuously monitor protected circuit packs and redundant common equipment.**

**10.6.10 DCS shall automatically switch to a protection circuit pack on detection of a failure or degradation of normal operation.**

**10.6.11 The underlying equipment used to provide DCS shall be equipped with a redundant power supply or a battery back-up.**

**10.6.12 BellSouth shall make available to MCIm spare facilities and equipment necessary for provisioning repairs, and to meet MCIm's maintenance standards as specified in the Provisioning and Maintenance sections.**

**10.6.13 At MCIm's option, BellSouth shall provide MCIm with real time performance monitoring and alarm data on the signals and the**

components of the underlying equipment used to provide DCS that actually impact MCIm's services.

10.6.14 Where Technically Feasible, at MCIm's option, BellSouth shall provide MCIm with real time ability to initiate tests on integrated equipment used to test the signals and the underlying equipment used to provide DCS, as well as other integrated functionality for routine testing and fault isolation.

10.6.15 Where Technically Feasible, DCS shall provide SONET to asynchronous gateway functionality (e.g., STS-1 to DS1 or STS-1 to DS3).

10.6.16 Where Technically Feasible, DCS shall perform optical to electrical conversion where the underlying equipment used to provide DCS contains optical interfaces or terminations (e.g., Optical Carrier level 3, i.e., OC-3, interfaces on a DCS 3/1).

10.6.17 Where Technically Feasible, DCS shall have SONET ring terminal functionality where the underlying equipment used to provide DCS acts as a terminal on a SONET ring.

10.6.18 Where Technically Feasible, DCS shall provide multipoint bridging of multiple channels to other DCSs. MCIm may designate multipoint bridging to be one-way broadcast from a single master to multiple tributaries, or two-way broadcast between a single master and multiple tributaries.

10.6.19 Where Technically Feasible, DCS shall multiplex lower speed channels onto a higher speed interface and demultiplex higher speed channels onto lower speed interfaces as designated by MCIm.

## 10.7 DCS Interface Requirements

10.7.1 BellSouth shall provide physical interfaces on DS0, DS1, and VT1.5 channel cross-connect devices at the DS1 rate or higher. In all such cases, these interfaces shall be in compliance with applicable Bellcore, ANSI, ITU, and MCIm standards.

10.7.2 BellSouth shall provide physical interfaces on DS3 channel cross-connect devices at the DS3 rate or higher. In all such cases, these interfaces shall be in compliance with applicable Bellcore, ANSI, ITU, and MCIm standards.

**MCImetro-BellSouth Florida Interconnection Agreement**

**10.7.3 BellSouth shall provide physical interfaces on STS-1 cross-connect devices at the OC-3 rate or higher. In all such cases, these interfaces shall be in compliance with applicable Bellcore, ANSI, ITU, and MCIm standards.**

**10.7.4 Interfaces on all other cross-connect devices shall be in compliance with applicable Bellcore, ANSI, ITU, and MCIm standards.**

**10.8 DCS shall, at a minimum, meet all the requirements set forth in the following technical references:**

**10.8.1 ANSI T1.102-1993, American National Standard for Telecommunications - Digital Hierarchy - Electrical Interfaces;**

**10.8.2 ANSI T1.102.01-199x, American National Standard for Telecommunications - Digital Hierarchy - VT1.5;**

**10.8.3 ANSI T1.105-1995, American National Standard for Telecommunications - Synchronous Optical Network (SONET) - Basic Description including Multiplex Structure, Rates and Formats;**

**10.8.4 ANSI T1.105.03-1994, American National Standard for Telecommunications - Synchronous Optical Network (SONET) - Jitter at Network Interfaces;**

**10.8.5 ANSI T1.105.03a-1995, American National Standard for Telecommunications - Synchronous Optical Network (SONET): Jitter at Network Interfaces - DS1 Supplement;**

**10.8.6 ANSI T1.105.06-199x, American National Standard for Telecommunications - Synchronous Optical Network (SONET) - Physical Layer Specifications;**

**10.8.7 ANSI T1.106-1988, American National Standard for Telecommunications - Digital Hierarchy - Optical Interface Specifications (Single Mode);**

**10.8.8 ANSI T1.107-1988, American National Standard for Telecommunications - Digital Hierarchy - Formats Specifications;**

**10.8.9 ANSI T1.107a-1990, American National Standard for Telecommunications - Digital Hierarchy - Supplement to Formats Specifications (DS3 Format Applications);**

10.8.10 ANSI T1.107b-1991, American National Standard for Telecommunications - Digital Hierarchy - Supplement to Formats Specifications;

10.8.11 ANSI T1.117-1991, American National Standard for Telecommunications - Digital Hierarchy - Optical Interface Specifications (SONET) (Single Mode - Short Reach);

10.8.12 ANSI T1.403-1989, Carrier to Subscriber Installation, DS1 Metallic Interface Specification;

10.8.13 ANSI T1.404-1994, Network-to-Subscriber Installation - DS3 Metallic Interface Specification;

10.8.14 FR-440 and TR-NWT-000499, Transport Systems Generic Requirements (TSGR): Common Requirements;

10.8.15 GR-820-CORE, Generic Transmission Surveillance: DS1 & DS3 Performance;

10.8.16 GR-253-CORE, Synchronous Optical Network Systems (SONET); Common Generic Criteria; and

10.8.17 TR-NWT-000776, Network Interface Description for ISDN Subscriber Access.

## **Section 11. Signaling Link Transport -**

### **11.1 Definition:**

Signaling Link Transport is a set of two or four dedicated 56 Kbps transmission paths between MCI/m-designated Signaling Points of Interconnection (SPOI) that provides appropriate physical diversity and a cross connect at a BellSouth STP site.

### **11.2 Technical Requirements**

11.2.1 Signaling Link Transport shall consist of full duplex mode 56 Kbps transmission paths.

11.2.2 Of the various options available, Signaling Link Transport shall perform in the following two ways:

## **MCImetro-BellSouth Florida Interconnection Agreement**

11.2.2.1 As an "A-link" which is a connection between a switch or SCP and a home Signaling Transfer Point Switch (STPs) pair; and

11.2.2.2 As a "D-link" which is a connection between two STPs pairs in different company networks (e.g., between two STPs pairs for two Competitive Local Exchange Carriers (CLECs)).

11.2.3 Signaling Link Transport shall consist of two or more signaling link layers as follows:

11.2.3.1 An A-link layer shall consist of two links.

11.2.3.2 A D-link layer shall consist of four links.

11.2.4 A signaling link layer shall satisfy a performance objective such that:

11.2.4.1 There shall be no more than two minutes down time per year for an A-link layer, and

11.2.4.2 There shall be negligible (less than 2 seconds) down time per year for a D-link layer.

11.2.5 A signaling link layer shall satisfy interoffice and intraoffice diversity of facilities and equipment, such that:

11.2.5.1 No single failure of facilities or equipment causes the failure of both links in an A-link layer (i.e., the links should be provided on a minimum of two separate physical paths end-to-end); and

11.2.5.2 No two concurrent failures of facilities or equipment shall cause the failure of all four links in a D-link layer (i.e., the links should be provided on a minimum of three separate physical paths end-to-end).

### **11.3 Interface Requirements**

11.3.1 There shall be a DS1 (1.544 Mbps) interface at the MCIm-designated SPOIs. Each 56 Kbps transmission path shall appear as a DS0 channel within the DS1 interface.

## **Section 12. Signaling Transfer Points (STPs) -**

12.1 Definition:

Signaling Transfer Points (STPs) provide functionality that enable the exchange of SS7 messages among and between switching elements, database elements and signaling transfer points. Figure 4 depicts Signaling Transfer Points.

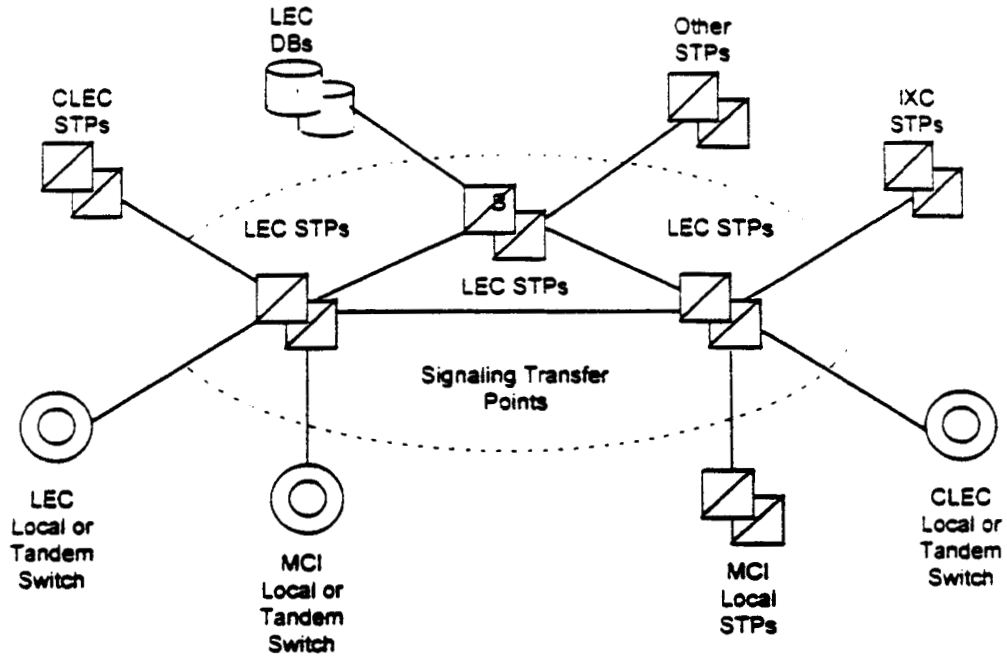

Figure 4

12.2 Technical Requirements

12.2.1 STPs shall provide access to all other Network Elements connected to the BellSouth SS7 network. These include:

12.2.1.1 BellSouth Local Switching or Tandem Switching;

12.2.1.2 BellSouth Service Control Points/DataBases;

12.2.1.3 Third-party local or tandem switching systems; and

**12.2.1.4 Third-party-provided STPs.**

**12.2.2** The connectivity provided by STPs shall fully support the functions of all other Network Elements connected to BellSouth's SS7 network. This explicitly includes the use of BellSouth's SS7 network to convey messages which neither originate nor terminate at a signaling end point directly connected to the BellSouth SS7 network (i.e., transit messages). When the BellSouth SS7 network is used to convey transit messages, there shall be no alteration of the Integrated Services Digital Network User Part (ISDNUP) or Transaction Capabilities Application Part (TCAP) user data that constitutes the content of the message.

**12.2.3** If a BellSouth tandem switch routes calling traffic, based on dialed or translated digits, on SS7 trunks between an MCIm local switch and third party local switch, BellSouth's SS7 network shall convey the TCAP messages that are necessary to provide Call Management features (Automatic Callback, Automatic Recall, and Screening List Editing) between the MCIm local STPs and the STPs that provide connectivity with the third party local switch, even if the third party local switch is not directly connected to BellSouth's STPs.

**12.2.4** STPs shall provide all functions of the MTP as specified in ANSI T1.111 (Reference 12.5.2). This includes:

**12.2.4.1** Signaling Data Link functions, as specified in ANSI T1.111.2;

**12.2.4.2** Signaling Link functions, as specified in ANSI T1.111.3; and

**12.2.4.3** Signaling Network Management functions, as specified in ANSI T1.111.4.

**12.2.5** STPs shall provide all functions of the SCCP necessary for Class 0 (basic connectionless) service, as specified in ANSI T1.112 (Reference 12.5.4). In particular, this includes Global Title Translation (GTT) and SCCP Management procedures, as specified in T1.112.4.

**12.2.6** In cases where the destination signaling point is a BellSouth local or tandem switching system or data base, or is an MCIm or third party local or tandem switching system directly connected to BellSouth's SS7 network, BellSouth STPs shall



## **MCImetro-BellSouth Florida Interconnection Agreement**

perform final GTT of messages to the destination and SCCP Subsystem Management of the destination. In all other cases, STPs shall perform intermediate GTT of messages to a gateway pair of STPs in an SS7 network connected with the BellSouth SS7 network, and shall not perform SCCP Subsystem Management of the destination.

12.2.7 STPs shall also provide the capability to route SCCP messages based on ISNI, as specified in ANSI T1.118 (Reference 12.5.7), when this capability becomes available on BellSouth STPs.

12.2.8 STPs shall provide all functions of the OMAP commonly provided by STPs, as specified in the reference in Section 12.5.6. Upon MCIm request, BellSouth will identify the switches in which OMAP functionality is available. This includes:

12.2.8.1 MTP Routing Verification Test (MRVT); and,

12.2.8.2 SCCP Routing Verification Test (SRVT).

12.2.9 In cases where the destination signaling point is a BellSouth local or tandem switching system or DB, or is an MCIm or third party local or tandem switching system directly connected to the BellSouth SS7 network, STPs shall perform MRVT and SRVT to the destination signaling point. In all other cases, STPs shall perform MRVT and SRVT to a gateway pair of STPs in an SS7 network connected with the BellSouth SS7 network. This requirement shall be superseded by the specifications for Internetwork MRVT and SRVT if and when these become approved ANSI standards and available capabilities of BellSouth STPs, and when mutually agreed upon by MCIm and BellSouth.

12.2.10 STPs shall be equal to or better than the following performance requirements:

12.2.10.1 MTP Performance, as specified in ANSI T1.111.6; and

12.2.10.2 SCCP Performance, as specified in ANSI T1.112.5.

## **12.3 Interface Requirements**

12.3.1 BellSouth shall provide the following STPs options to connect MCI or MCI-designated local switching systems or STPs to the BellSouth SS7 network:

12.3.1.1 An A-link interface from MCI local switching systems; and,

12.3.2 Each type of interface shall be provided by one or more sets (layers) of signaling links, as follows:

12.3.2.1 An A-link layer shall consist of two links, as depicted in Figure 6.

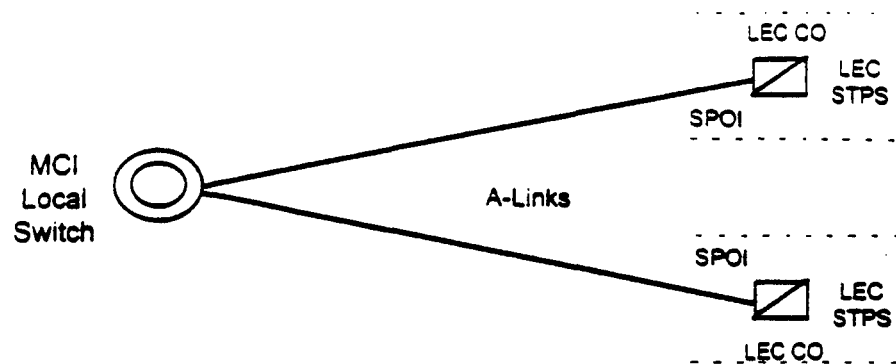

Figure 6. A-Link Interface

12.3.3 The Signaling point of Interconnection (SPOI) for each link shall be located at a cross-connect element, such as a DSX-1, in the Central Office (CO) where the BellSouth STPs is located. There shall be a DSI or higher rate transport interface at each of the SPOIs. Each signaling link shall appear as a DS0 channel within the DS1 or higher rate interface.

BellSouth shall offer higher rate DS1 signaling for interconnecting MCI local switching systems or STPs with BellSouth STPs as soon as these become approved ANSI standards and available capabilities of BellSouth STPs. MCI and ILEC shall cooperate to establish mutually agreed upon SPOI's.

12.3.4 BellSouth shall provide MTP and SCCP protocol interfaces that shall conform to all sections relevant to the MTP or SCCP in the following specifications:

12.3.4.1 Bellcore GR-905-CORE, Common Channel Signaling Network Interface Specification (CCSNIS) Supporting Network Interconnection, Message Transfer Part (MTP), and Integrated Services Digital Network User Part (ISDNUP); and

12.3.4.2 Bellcore GR-1432-CORE, CCS Network Interface Specification (CCSNIS) Supporting Signaling Connection Control Part (SCCP) and Transaction Capabilities Application Part (TCAP).

## 12.4 Message Screening

12.4.1 BellSouth shall set message screening parameters so as to accept messages from MCIm local or tandem switching systems destined to any signaling point in the BellSouth SS7 network with which the MCIm switching system has a legitimate signaling relation.

12.4.2 BellSouth shall set message screening parameters so as to accept messages from MCIm local or tandem switching systems destined to any signaling point or network interconnected to the BellSouth SS7 network with which the MCIm switching system has a legitimate signaling relation:

12.4.3 BellSouth shall set message screening parameters so as to accept messages destined to an MCIm local or tandem switching system from any signaling point or network interconnected to the BellSouth SS7 network with which the MCIm switching system has a legitimate signaling relation.

12.4.4 BellSouth shall set message screening parameters so as to accept and send messages destined to an MCIm SCP from any signaling point or network interconnected to the BellSouth SS7 network with which the MCIm SCP has a legitimate signaling relation.

## 12.5 STP Requirements

12.5.1 STPs shall be equal to or better than all of the requirements for STPs set forth in the following technical references:

12.5.2 ANSI T1.111-1992 American National Standard for Telecommunications - Signaling System Number 7 (SS7) - Message Transfer Part (MTP);

12.5.3 ANSI T1.111A-1994 American National Standard for Telecommunications - Signaling System Number 7 (SS7) - Message Transfer Part (MTP) Supplement;

12.5.4 ANSI T1.112-1992 American National, Standard for Telecommunications - Signaling System Number 7 (SS7) - Signaling Connection Control Part (SCCP);

12.5.5 ANSI T1.115-1990 American National Standard for Telecommunications - Signaling System Number 7 (SS7) - Monitoring and Measurements for Networks;

12.5.6 ANSI T1.116-1990 American National Standard for Telecommunications - Signaling System Number 7 (SS7) - Operations, Maintenance and Administration Part (OMAP);

12.5.7 ANSI T1.118-1992 American National Standard for Telecommunications - Signaling System Number 7 (SS7) - Intermediate Signaling Network Identification (ISNI);

12.5.8 Bellcore GR-905-CORE, Common Channel Signaling Network Interface Specification (CCSNIS) Supporting Network Interconnection, Message Transfer Part (MTP), and Integrated Services Digital Network User Part (ISDNUP); and

12.5.9 Bellcore GR-1432-CORE, CCS Network Interface Specification (CCSNIS) Supporting Signaling Connection Control Part (SCCP) and Transaction Capabilities Application Part (TCAP).

### ***Section 13. Service Control Points/Databases***

#### **13.1 Definition**

13.1.1 Databases are the Network Elements that provide the functionality for storage of, access to, and manipulation of information required to offer a particular service and/or capability. Databases include, but are not limited to: Number Portability, LIDB, Toll Free Number Database, Automatic Location Identification/Data Management System, and AIN.

13.1.2 A Service Control Point (SCP) is a specific type of Database Network Element functionality deployed in a Signaling System 7 (SS7) network that executes service application logic in

response to SS7 queries sent to it by a switching system also connected to the SS7 network. SCPs also provide operational interfaces to allow for provisioning, administration and maintenance of subscriber data and service application data. (e.g., an 800 database stores subscriber record data that provides information necessary to route 800 calls).

### 13.2 Technical Requirements for SCPs/Databases

Requirements for SCPs/Databases within this section address storage of information, access to information (e.g. signaling protocols, response times), and administration of information (e.g., provisioning, administration, and maintenance). All SCPs/Databases shall be provided to MCI/m in accordance with the following requirements, except where such a requirement is superseded by specific requirements set forth in Subsections 13.3 through 13.7:

13.2.1 BellSouth shall provide physical interconnection to SCPs through the SS7 network and protocols, as specified in Section 12 of this Attachment, with TCAP as the application layer protocol.

13.2.2 BellSouth shall provide physical interconnection to databases via industry standard interfaces and protocols (e.g., ISDN and X.25).

13.2.3 The reliability of interconnection options shall be consistent with requirements for diversity and survivability as specified in Section 12 of this Attachment (which applies to both SS7 and non-SS7 interfaces).

13.2.4 Database functionality shall be unavailable a maximum of 30 minutes per year.

13.2.5 BellSouth shall provide Database provisioning consistent with the provisioning requirements of this Agreement (e.g., data required, edits, acknowledgments, data format and transmission medium and notification of order completion).

13.2.6 The operational interface provided by BellSouth shall complete Database transactions (i.e., add, modify, delete) for MCI/m subscriber records stored in BellSouth databases within an interval at parity with BellSouth's own provisioning schedule.

13.2.7 BellSouth shall provide Database maintenance consistent with the maintenance requirements as specified in this Agreement

## **MCImetro-BellSouth Florida Interconnection Agreement**

(e.g., notification of BellSouth Network Affecting Events, testing, dispatch schedule and measurement and exception reports).

13.2.8 BellSouth shall provide billing and recording information to track database usage consistent with connectivity billing and recording requirements as specified in this Agreement (e.g., recorded message format and content, timeliness of feed, data format and transmission medium).

13.2.9 BellSouth shall provide SCPs/Databases in accordance with the physical security requirements specified in this Agreement.

13.2.10 BellSouth shall provide SCPs/Databases in accordance with the logical security requirements specified in this Agreement.

### **13.3 Number Portability Database**

Permanent Number Portability (PNP) is currently being worked in industry forums. The results of these forums will dictate the industry direction of PNP. BellSouth and MCIm agree to implement PNP as directed by the FCC as a result of final, nonappealable orders in FCC Docket 95-116 and the appropriate industry forums.

### **13.4 Line Information Database (LIDB)**

This Subsection 13.4 defines and sets forth additional requirements for the Line Information Database. This Subsection 13.4 supplements the requirements of Subsection 13.2 and 13.7.

#### **13.4.1 Definition:**

The Line Information Database (LIDB) is a transaction-oriented database accessible through Common Channel Signaling (CCS) networks. It contains records associated with subscriber Line Numbers and Special Billing Numbers (in accordance with the requirements in the technical reference in Section 13.7.5). LIDB accepts queries from other Network Elements, or MCIm's network, and provides appropriate responses. The query originator need not be the owner of LIDB data. LIDB queries include functions such as screening billed numbers that provides the ability to accept Collect or Third Number Billing calls and validation of Telephone Line Number based non-proprietary calling cards. The interface for the LIDB functionality is the interface between the BellSouth CCS network and other CCS networks. LIDB also interfaces to administrative systems. The administrative system interface

provides Work Centers with an interface to LIDB for functions such as provisioning, auditing of data, access to LIDB measurements and reports.

#### 13.4.2 Technical Requirements

13.4.2.1 Prior to the availability of a long-term solution for Number Portability, BellSouth shall enable MCIm to store in BellSouth's LIDB any subscriber Line Number or Special Billing Number record, (in accordance with the technical reference in Section 13.7.5) whether ported or not, for which the NPA-NXX or NXX-0/IXX Group is supported by that LIDB.

13.4.2.1.1 MCIm agrees that it will accept responsibility for telecommunications services billed by BellSouth for its billing and collection customers for MCIm's end user accounts which are resident in LIDB pursuant to this Agreement. MCIm authorizes BellSouth to place such charges on MCIm's bill from BellSouth and agrees that it shall pay such charges. Charges for which MCIm hereby takes responsibility include, but are not limited to, collect and third number calls.

13.4.2.1.2 Charges for such services shall appear on a separate BellSouth bill page identified with the name of the entity for which BellSouth is billing the charge.

13.4.2.1.3 MCIm shall have the responsibility to render a billing statement to its end users for these charges, but MCIm's obligation to pay BellSouth for the charges billed shall be independent of whether MCIm is able or not to collect from MCIm's end users.

13.4.2.1.4 BellSouth shall not become involved in any disputes between MCIm and the entities for which BellSouth performs billing and collection. BellSouth will not issue adjustments for charges billed on behalf of an entity to MCIm. It shall be the responsibility of MCIm and the other entity to negotiate and arrange for any appropriate adjustments.

13.4.2.2 Prior to the availability of a long-term solution for Number Portability, BellSouth shall enable MCIm to store in BellSouth's LIDB any subscriber Line Number or Special Billing Number (in accordance with the technical reference in Section 13.7.5) record, whether ported or not, and NPA-NXX and NXX-0/1XX Group Records, belonging to an NPA-NXX or NXX-0/1 XX owned by MCIm.

13.4.2.3 Prior to the availability of a long-term solution for Number Portability, BellSouth shall enable MCIm to store in BellSouth's LIDB any subscriber Line Number or Special Billing Number (in accordance with the technical reference in Section 13.7.5) record, whether ported or not, regardless of the number's NPA-NXX or NXX-0/1XX.

13.4.2.4 BellSouth shall perform the following LIDB functions (i.e., processing of the following query types as defined in the technical reference in Section 13.7.5) for MCIm's subscriber records in LIDB:

13.4.2.4.1 Billed Number Screening (provides information such as whether the Billed Number may accept Collect or Third Number Billing calls); and

13.4.2.4.2 nonproprietary Calling Card Validation.

13.4.2.5 BellSouth shall process MCIm's subscriber records in LIDB at least at parity with BellSouth subscriber records, with respect to other LIDB functions (as defined in the technical reference in Section 13.5). BellSouth shall indicate to MCIm what additional functions (if any) are performed by LIDB in their network.

13.4.2.6 Within two (2) weeks after a request by MCIm, BellSouth shall provide MCIm with a list of the subscriber data items which MCIm would have to provide in order to support each required LIDB function. The list shall indicate which data items are essential to LIDB function, and which are required only to support certain services. For each data item, the list shall show the data formats, the acceptable values of the data item and the meaning of those values.

13.4.2.7 BellSouth shall provide LIDB systems for which operating deficiencies that would result in calls being blocked, shall not exceed 30 minutes per year.



13.4.2.8 BellSouth shall provide LIDB systems for which operating deficiencies that would not result in calls being blocked shall not exceed 12 hours per year.

13.4.2.9 BellSouth shall provide LIDB systems for which the LIDB function shall be in overload (degraded performance in accordance with the technical reference in Section 13.7.5) no more than 12 hours per year. Such deficiency period is in addition to the periods specified in Sections 13.4.2.7 and 13.4.2.8 above.

13.4.2.10 BellSouth shall provide MCIIm with the capability to provision (e.g., to add, update, and delete) NPA-NXX and NXX-0/IXX Group Records, and Line Number and Special Billing Number Records, associated with MCIIm subscribers, directly into BellSouth's LIDB provisioning (i.e. service order) process.

13.4.2.11 Unless directed otherwise by MCIIm, in the event that end user subscribers change their local service provider, BellSouth shall maintain subscriber data (for line numbers, card numbers, and for any other types of data maintained in LIDB) so that such subscribers shall not experience any interruption of service due to the lack of such maintenance of subscriber data. In the event that end user subscribers change their local service provider, BellSouth shall use its best efforts to avoid service interruption in those situations where BellSouth has control over additions and deletions in the database as LIDB provider.

13.4.2.12 All additions, updates and deletions of MCIIm data to the LIDB shall be solely at the direction of MCIIm.

13.4.2.13 BellSouth shall provide, at parity, priority updates to LIDB for MCIIm data upon MCIIm's request (e.g., to support fraud protection).

13.4.2.14 BellSouth shall provide MCIIm reports of all MCIIm data in LIDB.

13.4.2.15 Pursuant to BellSouth procedures, BellSouth shall provide LIDB systems such that no more than 0.01% of

MCIm subscriber records will be missing from LIDB, as measured by MCIm audits.

13.4.2.16 BellSouth shall perform backup and recovery of all of MCIm's data in LIDB at parity, including sending to LIDB all changes made since the date of the most recent backup copy.

13.4.2.17 BellSouth shall provide to MCIm access to LIDB measurements and reports at least at parity with the capability BellSouth has for its own subscriber records and that BellSouth provides to any other party.

13.4.2.18 BellSouth shall provide MCIm with LIDB reports of data which are missing or contain errors, as well as any misroute errors, within the time period reasonably negotiated between MCIm and BellSouth.

13.4.2.19 BellSouth shall prevent any access to or use of MCIm data in LIDB by BellSouth personnel or by any other party that is not authorized by MCIm in writing.

13.4.2.20 BellSouth shall provide MCIm performance of the LIDB Data Screening function, which allows a LIDB to completely or partially deny specific query originators access to LIDB data owned by specific data owners, (in accordance with the technical reference in Section 13.7.5) for Subscriber Data that is part of an NPA-NXX or NXX-0/1XX wholly or partially owned by MCIm at least at parity with BellSouth Subscriber Data. BellSouth shall obtain from MCIm the screening information associated with LIDB Data Screening of MCIm data in accordance with this requirement.

13.4.2.21 BellSouth shall accept queries to LIDB associated with MCIm subscriber records, and shall return responses in accordance with the requirements of this Section 13.

13.4.2.22 BellSouth shall provide mean processing time at the LIDB within 0.50 seconds under normal conditions as defined in the technical reference in Section 13.7.5.

13.4.2.23 BellSouth shall provide processing time at the LIDB within 1 second for 99% of all messages under normal conditions as defined in the technical reference in Section 13.7.5.

13.4.2.24 BellSouth shall provide 99.9 % of all LIDB queries in a round trip response within 2 seconds.

13.4.2.25 BellSouth shall provide LIDB performance that complies with the standards set forth below in sections 13.4.2.25.1 through 13.4.2.25.6.3. If MCIIm requests, in writing, a higher level of performance than BellSouth provides to its own subscribers, BellSouth shall inform MCIIm, in writing, of the amount MCIIm's desired performance level exceeds that which BellSouth provides to its subscribers as well as a reasonable estimate of what it would cost BellSouth to meet, measure, and report these standards. If MCIIm then communicates, in writing, to BellSouth that it desires such higher levels of performance, MCIIm shall pay BellSouth for the costs incurred in providing such higher level of service. Moreover, MCIIm shall pay all mechanisms necessary to capture and report data, required to measure, report or track any performance measurement that BellSouth does not, as of the Effective Date, measure, report or track for itself or its own subscribers. In the event such system is not developed exclusively for MCIIm, but rather is developed for use with other CLECs, as well as MCIIm, BellSouth shall allocate to MCIIm, on a competitively neutral basis, MCIIm's share of the costs associated with such system.

13.4.2.25.1 There shall be at least a 99.9% reply rate to all query attempts.

13.4.2.25.2 Queries shall time out at LIDB no more than 0.1% of the time.

13.4.2.25.3 Data in LIDB replies shall have at no more than 2% unexpected data values, for all queries to LIDB.

13.4.2.25.4 No more than 0.01% of all LIDB queries shall return a missing subscriber record.

13.4.2.25.5 There shall be no defects in LIDB Data Screening of responses.

13.4.2.25.6 Group troubles shall occur for no more than 1% of LIDB queries. Group troubles include:

## **MCImetro-BellSouth Florida Interconnection Agreement**

**13.4.2.25.6.1 Missing Group** — When reply is returned "vacant" but there is no active record for the 6-digit NPA-NXX group.

**13.4.2.25.6.2 Vacant Code** — When a 6-digit code is active but is not assigned to any subscriber on that code.

**13.4.2.25.6.3 Non-Participating Group and unavailable Network Resource** — should be identified in the LARG (LIDB Access Routing Guide) so MCIm does not pay access for queries that will be denied in LIDB.

### **13.4.3 Interface Requirements**

BellSouth shall offer LIDB in accordance with the requirements of this subsection 13.4.3.

**13.4.3.1** The interface to LIDB shall be in accordance with the technical reference in Section 13.7.3.

**13.4.3.2** The CCS interface to LIDB shall be the standard interface described in Section 13.7.3.

**13.4.3.3** The LIDB Data Base interpretation of the ANSI-TCAP messages shall comply with the technical reference in Section 13.7.4. Global Title Translation shall be maintained in the signaling network in order to support signaling network routing to the LIDB.

### **13.5 Toll Free Number Database**

The Toll Free Number Database is a SCP that provides functionality necessary for toll free (e.g., 800 and 888) number services by providing routing information and additional so-called vertical features during call set-up in response to queries from SSPs. This Subsection 13.5 supplements the requirements of Subsection 13.2 and 13.7. BellSouth shall provide the Toll Free Number Database in accordance with the following:

#### **13.5.1 Technical Requirements**

## **MCImetro-BellSouth Florida Interconnection Agreement**

**13.5.1.1** BellSouth shall make the BellSouth Toll Free Number Database available for MCIm to query, from MCIm's designated switch including BellSouth unbundled local switching, with a toll-free number and originating information.

**13.5.1.2** The Toll Free Number Database shall return carrier identification and, where applicable, the queried toll free number, translated numbers and instructions as it would in response to a query from a BellSouth switch.

**13.5.1.3** The SCP shall also provide, at MCIm's option, such additional features as described in SR-TSV-002275 (BOC Notes on the BellSouth Networks, SR-TSV-002275, Issue 2, (Bellcore, April 1994)) as are available to BellSouth. These may include but are not limited to:

**13.5.1.3.1** Network Management;

**13.5.1.3.2** Subscriber Sample Collection, at charges set forth in Attachment I; and

**13.5.1.3.3** Service Maintenance.

### **13.5.2 Interface Requirements**

The signaling interface between the MCIm or other local switch and the Toll-Free Number database shall use the TCAP protocol as specified in the technical reference in Section 13.7.1, together with the signaling network interface as specified in the technical reference in Sections 13.7.2 and 13.7.6.

### **13.6 Automatic Location Identification/Data Management System (ALI/DMS)**

The ALI/DMS Database contains subscriber information (including name, address, telephone information, and sometimes special information from the local service provider or subscriber) used to determine to which Public Safety Answering Point (PSAP) to route the call. The ALI/DMS database is used to provide more routing flexibility for E911 calls than Basic 911. This Subsection 13.6 supplements the requirements of Subsection 13.7.2 and 13.7.6. BellSouth shall provide the Emergency Services Database in accordance with the following:

#### **13.6.1 Technical Requirements**

## **MCImetro-BellSouth Florida Interconnection Agreement**

**13.6.1.1 BellSouth shall offer MCIm a data link to the ALI/DMS database or permit MCIm to provide its own data link to the ALI/DMS database.**

**BellSouth shall provide error reports from the ALI/DMS data base to MCIm after MCIm inputs information into the ALI/DMS data base. Alternately, MCIm may utilize BellSouth to enter through the service order process subscriber information into the data base on a demand basis, and validate subscriber information on a demand basis.**

**13.6.1.2 The ALI/DMS database shall contain the following subscriber information:**

**13.6.1.2.1 Name;**

**13.6.1.2.2 Address;**

**13.6.1.2.3 Telephone number; and**

**13.6.1.2.4 Other information as BellSouth deems appropriate**

**13.6.1.3 When BellSouth is responsible for administering the ALI/DMS database in its entirety, ported number NXXs entries for the ported numbers should be maintained unless MCIm requests otherwise and shall be updated if MCIm requests.**

**13.6.1.4 When Remote Call Forwarding (RCF) is used to provide number portability to the local subscriber and a remark or other appropriate field information is available in the database, the shadow or "forwarded-to" number and an indication that the number is ported shall be added to the subscriber record.**

**13.6.1.5 If BellSouth is responsible for configuring PSAP features (for cases when the PSAP or BellSouth supports an ISDN interface) it shall ensure that CLASS Automatic Recall (Call Return) is not used to call back to the ported number.**

### **13.6.2 Interface Requirements -**

**MCImetro-BellSouth Florida Interconnection Agreement**

13.6.2.1 The interface between the E911 Switch or Tandem and the ALI/DMS database for MCIm subscribers shall meet industry standards.

13.7 Where Technically Feasible, SCPs/Databases shall be equal to or better than all of the requirements for SCPs/Databases set forth in the following technical references:

13.7.1 GR-246-CORE, Bell Communications Research Specification of Signaling System Number 7, ISSUE 1 (Bellcore, December 1999);

13.7.2 GR-1432-CORE, CCS Network Interface Specification (CCSNIS) Supporting Signaling Connection Control Part (SCCP) and Transaction Capabilities Application Part (TCAP). (Bellcore, March 1994);

13.7.3 GR-954-CORE, CCS Network Interface Specification (CCSNIS) Supporting Line Information Database (LIDB) Service 6, Issue 1, Rev. 1 (Bellcore, October 1995);

13.7.4 GR-1149-CORE, OSSGR Section 10: System Interfaces, Issue 1 (Bellcore, October 1995) (Replaces TR-NWT-001149);

13.7.5 GR-1158-CORE, OSSGR Section 22.3: Line Information Database 6, Issue (Bellcore, October 1995)

13.7.6 GR-1428-CORE, CCS Network Interface Specification (CCSNIS) Supporting Toll Free Service (Bellcore, May 1995); and

13.7.7 "Bellcore Special Report SR-TSV-002275, IBOC Notes on the LEC Networks - Signaling".)

**13.8 Advanced Intelligent Network (AIN) Access, Service Creation Environment and Service Management System (SCE/SMS) Advanced Intelligent Network Access**

13.8.1 BellSouth will make all BellSouth SCP-based AIN retail services available for resale to MCIm. MCIm will be given the opportunity to develop competitive AIN 0.1 service applications via unbundled access to BellSouth's SCE/SMS. Where Technically Feasible, access to BellSouth resold services and MCIm created services may be supported from both MCIm and BellSouth local switches.

13.8.2 SCE/SMS AIN Access shall provide MCIm the ability to create service applications utilizing BellSouth AIN 0.1 service creation tools and deploy those applications via the BellSouth SMS to the BellSouth SCPs. Through traditional mechanisms, MCIm will be supported in provisioning switch triggers in BellSouth local switches which will access these applications. AIN SCE/SMS service development capabilities provided to MCIm will provide the same AIN 0.1 service development opportunities as presented to BellSouth in utilization of its basic AIN programmability tools (DesignEDGE service). See Figure 7 below.

13.8.2.1 BellSouth will participate in standards bodies actively pursuing SMS/SCE standards. If standards are adopted in this area, BellSouth will seek to evolve its AIN SMS/SCE access toward such standards.

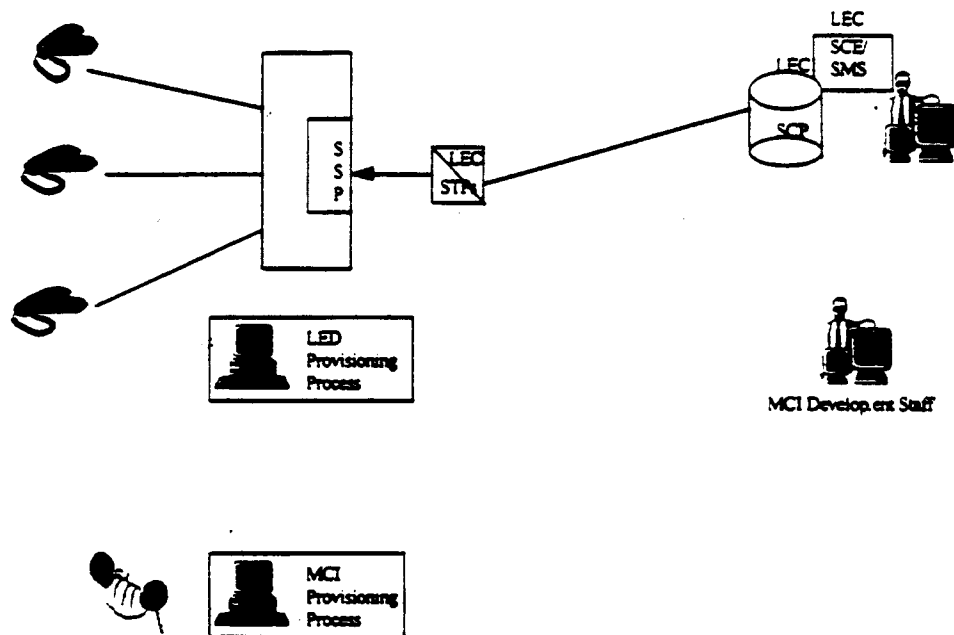

Figure 7

13.8.3 BellSouth's SCE/SMS offering shall provide access to SCE hardware, software, testing and technical support (e.g., help desk, system administrator) resources available to MCIm on a



## MCI/metro-BellSouth Florida Interconnection Agreement

reasonable basis. Scheduling procedures shall provide MCI/m equal priority access to these resources.

13.8.4 AIN access BellSouth shall allow for multi-user access with proper source code management and other logical security functions as specified in the Security section of this Agreement.

13.8.5 The BellSouth SCP shall partition and protect MCI/m service logic and data from unauthorized access, execution or other types of compromise.

13.8.6 When MCI selects SCE/SMS AIN access, BellSouth shall provide adequate training, documentation, and technical support of MCI/m development staff to reasonably expect successful application development. Such training shall address use of SCE/SMS AIN access and administrative functions, but will not include support for creation of a specific service application.

13.8.7 BellSouth will provide a secure controlled access environment in association with its internal utilization of AIN components. When MCI/m utilizes BellSouth's SCE/SMS, AIN Access will be provided via remote data connections (e.g., dial up, LAN, WAN) to published specifications.

13.8.8 When MCI/m selects SCE/SMS AIN Access, BellSouth shall allow MCI/m to download data forms and/or tables to the BellSouth SCP via the BellSouth SMS without intervention from BellSouth (e.g., service customization and subscriber subscription).

13.8.9 BellSouth shall offer, through the SCE/SMS AIN Access, access to the SCPs/Databases for control of MCI/m end user functionality.

### **Section 14. Tandem Switching**

#### **14.1 Definition:**

Tandem Switching is the function that establishes a communications path between two switching offices through a third switching office (the tandem switch). BellSouth shall provide MCI/m with selective routing via Line Class Codes on a first-come, first-served basis. Further, MCI/m and BellSouth shall continue to work with the appropriate industry groups to develop a long term solution for selective routing. BellSouth may reserve for itself a reasonable number of line class codes.

**14.2 Technical Requirements**

**14.2.1 Tandem Switching shall have the same capabilities or equivalent capabilities as those described in Bell Communications Research TR-TSY-000540 Issue 2R2, Tandem Supplement, 6/1/90. The requirements for Tandem Switching include, but are not limited to, the following:**

**14.2.1.1 Tandem Switching shall provide signaling to establish a tandem connection;**

**14.2.1.2 Subject to section 14.1, above, Tandem Switching shall provide screening as jointly agreed to by MCI and BellSouth and routing on a per call basis as designated by MCI;**

**14.2.1.3 Tandem Switching shall provide recording of all billable events designated by MCI;**

**14.2.1.4 When Technically Feasible, and requested via BFR by MCI, Tandem Switching shall provide Advanced Intelligent Network triggers supporting AIN features;**

**14.2.1.5 Subject to section 14.1, above, Tandem Switching shall provide connectivity to Operator Systems as designated by MCI;**

**14.2.1.6 Tandem Switching shall provide access to Toll Free number portability database as designated by MCI;**

**14.2.1.7 Tandem Switching shall provide all trunk interconnections discussed under the "Network Interconnection" section (e.g., SS7, MF, DTMF, Dial Pulse, PRI-ISDN, DID, and CAMA-ANI (if appropriate for 911));**

**14.2.1.8 Tandem Switching shall provide connectivity to PSAPs where 911 solutions are deployed and the tandem is used for 911; and**

**14.2.1.9 Tandem Switching shall provide connectivity to transit traffic to and from other carriers.**

**14.2.2 Tandem Switching shall accept connections (including the necessary signaling and trunking interconnections) between end offices, other tandems, IECs, ICOs, CAPs and CLEC switches.**

**MCImetro-BellSouth Florida Interconnection Agreement**

**14.2.3 Tandem Switching shall provide local tandeming functionality between two end offices including two offices belonging to different CLEC's (e.g., between an MCI end office and the end office of another CLEC).**

**14.2.4 Tandem Switching shall preserve CLASS/LASS features and Caller ID as traffic is processed. Additional signaling information and requirements are provided in Section 12.**

**14.2.5 Tandem Switching shall record billable events and send them to the area billing centers designated by MCI. Billing requirements are specified in Attachment 8 of this Agreement.**

**14.2.6 Upon reasonable request, BellSouth shall perform routine testing and fault isolation on the underlying switch that is providing Tandem Switching and all its interconnections. When requested by MCI, the results and reports of the testing shall be made immediately available to MCI.**

**14.2.7 When requested by MCI, BellSouth shall provide performance data regarding traffic characteristics or other measurable elements to MCI for review.**

**14.2.8 Tandem Switching shall be capable of controlling congestion using capabilities such as Automatic Congestion Control (e.g. choke trunk groups) and Network Routing Overflow. Congestion control provided or imposed on MCI traffic shall be at parity with controls being provided or imposed on BellSouth traffic (e.g., BellSouth shall not block MCI traffic in a discriminatory manner).**

**14.2.9 Subject to section 14.1, above, Tandem Switching shall route calls to BellSouth or MCI endpoints or platforms (e.g., operator services and PSAPs) on a per call basis as designated by MCI. Detailed primary and overflow routing plans for all interfaces available within the BellSouth switching network shall be mutually agreed to by MCI and BellSouth. Such plans shall meet reasonable MCI requirements for routing calls through the local network.**

**14.2.10 Tandem Switching shall process originating toll-free traffic received from an MCI local switch.**

## **MCImetro-BellSouth Florida Interconnection Agreement**

**14.2.11** In support of AIN triggers and features, Tandem Switching, when Technically Feasible and requested via BFR by MCIm, shall provide SSP capabilities when these capabilities are not available from the Local Switching Network Element.

**14.2.12** The Local Switching and Tandem Switching functions may be combined in an office. If this is done, both Local Switching and Tandem switching shall provide all of the functionality required of each of those Network Elements in this Agreement.

### **14.3 Interface Requirements**

**14.3.1** Tandem Switching shall provide interconnection to the E911 PSAP where the underlying Tandem is acting as the E911 Tandem.

**14.3.2** Tandem Switching shall interconnect, with direct trunks, to all carriers with which BellSouth interconnects.

**14.3.3** BellSouth shall provide all signaling necessary to provide Tandem Switching with no loss of feature functionality.

**14.3.4** Tandem Switching shall interconnect with MCIm's switch, using two-way trunks, for traffic that is transiting via the BellSouth network to interLATA or intraLATA carriers. At MCIm's request, Tandem Switching shall record and keep records of traffic for billing.

**14.3.5** Tandem Switching shall provide an alternate final routing pattern for MCIm traffic overflowing from direct end office high usage trunk groups.

**14.4** Tandem Switching shall meet or exceed (i.e., be more favorable to MCIm) each of the requirements for Tandem Switching set forth in the following technical references:

**14.4.1** Bell Communications Research TR-TSY-000540 Issue 2R2, Tandem Supplement, 6/1/90;

**14.4.2** GR-905-CORE covering CCSNIS;

**14.4.3** GR-1429-CORE for call management features; and GR-2863-CORE and GR-2902-CORE covering CCS AIN interconnection.

**Section 15. Additional Requirements**

This Section 15 of Attachment III sets forth the additional requirements for unbundled Network Elements which BellSouth agrees to offer to MCIm under this Agreement.

**15.1 Cooperative Testing**

**15.1.1 Definition:**

Cooperative Testing means that BellSouth shall cooperate with MCIm upon request or as needed to (1) ensure that the Network Elements and Ancillary Functions and additional requirements being provided to MCIm by BellSouth are in compliance with the requirements of this Agreement, (2) test the overall functionality of various Network Elements and Ancillary Functions provided by BellSouth to MCIm in combination with each other or in combination with other equipment and facilities provided by MCIm or third parties, and (3) ensure that all operational interfaces and processes are in place and functioning properly and efficiently for the provisioning and maintenance of Network Elements and Ancillary Functions and so that all appropriate billing data can be provided to MCIm.

**15.1.2 Requirements**

Within ninety (90) days of the Effective Date of this Agreement, MCIm and BellSouth will agree upon a process to resolve technical issues relating to interconnection of MCIm's network to BellSouth's network and Network Elements and Ancillary Functions. The agreed upon process shall include procedures for escalating disputes and unresolved issues up through higher levels of each company's management. If MCIm and BellSouth do not reach agreement on such a process within ninety (90) days, any issues that have not been resolved by the parties with respect to such process shall be submitted to the procedures set forth in Part A Section 23 of this Agreement unless both parties agree to extend the time to reach agreement on such issues.

**15.1.2.1** BellSouth shall provide MCIm access for testing at any interface between a BellSouth Network Element or combinations and MCIm equipment or facilities. Such test access shall be sufficient to ensure that the applicable requirements can be tested by MCIm. This access shall be available seven (7) days per week, 24 hours per day.

15.1.2.2 MCIm may test any interfaces, Network Elements or Ancillary Functions and additional requirements provided by BellSouth pursuant to this Agreement.

15.1.2.3 BellSouth shall provide engineering data as requested by MCIm for the loop components as set forth in Sections 2, 3 and 4 of this Attachment which MCIm may desire to test. Such data shall include equipment engineering and cable specifications, signaling and transmission path data.

15.1.2.4 Upon MCIm's request, to the extent required by applicable commission orders or by subsequent agreement, BellSouth shall provide to MCIm any office records, central office layout and design records and drawings, system engineering and other applicable documentation pertaining to a Network Element or Ancillary Function or the underlying equipment that is then providing a Network Element or Ancillary Function to MCIm.

15.1.2.5 BellSouth shall provide to MCIm upon request, all applicable test results, from BellSouth testing activities on a Network Element or Ancillary Function or Additional Requirement or the underlying equipment providing a Network Element or Ancillary Function or Additional Requirements. MCIm may review such testing results and may notify BellSouth of any deficiencies that are detected.

15.1.2.6 BellSouth shall temporarily provision MCIm designated Local Switching features for testing. Within ninety (90) days of the Effective Date of this Agreement, MCIm and BellSouth shall mutually agree on the procedures to be established between BellSouth and MCIm to expedite such provisioning processes for feature testing.

15.1.2.7 Upon MCIm's request, BellSouth shall provide technical staff to meet with MCIm representatives to provide required support for Cooperative Testing.

15.1.2.8 Dedicated Transport and Loop Feeder may experience alarm conditions due to in-progress tests. BellSouth shall not remove such facilities from service without obtaining MCIm's prior approval.

## **MCImetro-BellSouth Florida Interconnection Agreement**

**15.1.2.9 BellSouth shall get acceptance from MCIIm prior to conducting tests or maintenance procedures on Network Elements or Ancillary Functions or on the underlying equipment that is then providing a Network Element or Ancillary Function, that may cause a service interruption or degradation of service**

**15.1.2.10 BellSouth shall provide a single point of contact to MCIIm that is available 7 days per week, 24 hours per day for trouble status, sectionalization, resolution, escalation, and closure. Such staff shall be adequately skilled to allow expeditious problem resolution.**

**15.1.2.11 BellSouth shall provide to MCIIm electronic access to 105 responders, 100-type test lines, or 102-type test lines associated with any circuits under test.**

**15.1.2.12 BellSouth shall participate in Cooperative Testing with MCIIm upon MCIIm's request to test any operational interface or process used to provide Network Elements, Ancillary Functions or Services to MCIIm.**

**15.1.2.13 MCIIm and BellSouth shall endeavor to complete Cooperative Testing as stated in Attachment 8.**

**15.1.2.14 BellSouth shall participate in Cooperative Testing requested by MCIIm whenever it is deemed necessary by MCIIm to insure service performance, reliability and subscriber serviceability.**

**15.1.2.15 MCIIm may accept or reject the Network Element ordered by MCIIm if, upon completion of cooperative acceptance testing, the tested Network Element does not meet the requirements stated herein.**

**15.1.2.16 BellSouth shall provide real-time, remote data access, where available to performance monitoring and alarm data on events affecting (or potentially affecting) MCIIm's traffic on BellSouth's network elements.**

## **15.2 Performance**

### **15.2.1 Scope**

## **MCImetro-BellSouth Florida Interconnection Agreement**

This section addresses performance requirements for Network Elements and Ancillary Functions to provide local service. It includes requirements for the reliability and availability of Network Elements and Ancillary Functions, and quality parameters such as transmission quality (analog and digital), and speed (or delay). In addition, an overview of service performance requirements is given. These requirements shall apply to the extent they are in conformance with, and applicable to BellSouth under, accepted industry standards, and MCI may request more stringent performance standards, if Technically Feasible, via the bona fide request process.

**15.2.1.1 The General Performance Requirements in this section apply to all aspects of Network Elements and Ancillary Functions. Additional requirements are given in this performance section and in the individual Network Elements sections.**

**15.2.1.2 BellSouth shall work cooperatively with MCI to determine appropriate performance allocations across Network Elements.**

**15.2.3 BellSouth shall provide performance equal to or better than all of the requirements set forth in the following technical references:**

**15.2.3.1 Bell Communications Research, Inc. Documents**

**15.2.3.1.1 FR-64, LATA Switching Systems Generic Requirements (LSSGR). This document contains 117 Technical References and Generic Requirements. Sections provide the requirements for local switching systems (also referred to as end offices) that serve subscribers' lines. Some modules of the LSSGR are also referenced separately in this document.**

**15.2.3.1.2 TR-NWT-000499, Issue 5, Rev 1, April 1992, Transport Systems Generic Requirements (TSGR): Common Requirements.**

**15.2.3.1.3 TR-NWT-000418, Issue 2, December 1992, Generic Reliability Assurance Requirements For Fiber Optic Transport Systems.**



MCI/metro-BellSouth Florida Interconnection Agreement

15.2.3.1.4 TR-NWT-000057, Issue 2, January 1993,  
Functional Criteria for Digital Loop Carriers Systems.

15.2.3.1.5 TR-NWT-000507, Issue 5, December  
1993, LSSGR - Transmission, Section 7.

15.2.3.1.6 GR-303-CORE, Issue 1, September 1995,  
Integrated Digital Loop Carrier System Generic  
Requirements, Objectives, and Interface.

15.2.3.1.7 GR-334-CORE, Issue 1, June 1994,  
Switched Access Service: Transmission Parameter  
Limits and Interface Combinations.

15.2.3.1.8 TR-NWT-000335, Issue 3, May 1993,  
Voice Grade Special Access Services - Transmission  
Parameter Limits and Interface Combinations.

15.2.3.1.9 TR-TSY-000529, Issue 2, July 1987,  
Public Safety - LSSGR.

15.2.3.1.10 GR-1158-CORE, Issue 2, October 1995,  
OSSGR Section 22.3: Line Information Database.

15.2.3.1.11 TR-TSY-000511, Issue 2, July 1987,  
Service Standards, a Module (Section 11) of LATA  
Switching Systems Generic Requirements (LSSGR,  
FR-NWT-000064).

15.2.3.1.12 TR-NWT-000393, January 1991, Generic  
Requirements for ISDN Basic Access Digital  
Subscriber Lines.

15.2.3.1.13 TR-NWT-000909, December 1991,  
Generic Requirements and Objectives for Fiber In  
The Loop Systems.

15.2.3.1.14 TR-NWT-000505, Issue 3, May 1991,  
LSSGR Section 5, Call Processing.

15.2.3.1.15 FR-NWT-000271, 1993, Operator  
Services Systems Generic Requirements (OSSGR).

## **MCImetro-BellSouth Florida Interconnection Agreement**

**15.2.3.1.16 TR-NWT-001156, Issue 2, July 1993, OSSGR Operator Services Systems Generic Requirements, Section 21, Operator Subsystem.**

**15.2.3.1.17 SR-TSY-001 171, Issue 1, January 1989, Methods and Procedures for System Reliability Analysis.**

**15.2.3.1.18 Bellcore Telecommunications Transmission Engineering, 3rd Ed, 1990.**

### **15.2.3.2 ANSI Standards**

**15.2.3.2.1 ANSI T1.512-1994, Network Performance - Point-to-Point Voice-Grade Special Access Network Voiceband Data Transmission Objectives.**

**15.2.3.2.2 ANSI T1.506-1990, Network Performance - Transmission Specifications for Switched Exchange Access Network.**

**15.2.3.2.3 ANSI T1.508-1992, Telecommunications - Network Performance - Loss Plan for Evolving Digital Networks. Also supplement T1.508a-1993.**

**15.2.3.2.4 ANSI T1.101-1994, Digital Synchronization Network Plan.**

### **15.2.3.3 TIA/EIA Standards**

**15.2.3.3.1 Requirements not specifically addressed here shall be found in the documents listed in Electronic Industries Association/Telecommunications Industries Association Standards and Engineering Publications.**

**15.2.3.3.2 TIA/EIA TSB-37A, Telephone Network Transmission Model for Evaluating Modem Performance.**

**15.2.3.3.3 TIA/EIA TSB-38, Test Procedure for Evaluation of 2-wire 4 kHz Voiceband Duplex Modems.**

**15.2.3.4 IEEE Standards**

**15.2.3.4.1 IEEE Standard 743-1984, IEEE Standard Methods and Equipment for Measuring Transmission Characteristics of Analog Voice Frequency Circuits.**

**15.2.3.4.2 ANSI/IEEE Standard 820-1984, Telephone Loop Performance Characteristics.**

**15.2.4 Services and Capabilities**

**15.2.4.1 All Network Elements shall provide performance sufficient, in combination with other Network Elements, to provide the following applications in accordance with the requirements of this document:**

**15.2.4.1.1 All types of voice services.**

**15.2.4.1.2 All types of voice-band data modem connections up to and including 28.8 Kbps V-34.**

**15.2.4.1.3 All types of FAX transmissions up to and including 14.4 Kbps group 3.**

**15.2.4.1.4 All CLASS/LASS features.**

**15.2.4.1.5 All Operator Systems.**

**15.2.4.2 The following capabilities shall be provided as applicable:**

**15.2.4.2.1 ISDN BRI**

**15.2.4.2.2 ISDN PRI**

**15.2.4.2.3 Switched Digital Data**

**15.2.4.2.4 Non-Switched Digital Data**

**15.2.4.2.5 Any types of Video applications that a subscriber may order**

**15.2.4.2.6 Any Coin Services the subscriber may order**

15.2.4.2.7 Frame Relay and ATM

15.2.4.2.8 Private Line Services

15.2.5 Specific Performance Requirements for Network Elements and Ancillary Functions

15.2.5.1 The following sections itemize performance parameters for Network Elements and Ancillary Functions. BellSouth shall provide performance equal to or better than all of the requirements set forth in this Section. Unless noted otherwise, requirements and objectives are given in terms of specific limits. This means that all tests (acceptance and ongoing performance) shall meet the limit(s) to satisfy the requirement.

15.2.5.2 Performance Allocation

15.2.5.2.1 Transmission path impairments may be classified as either analog or digital, and will depend on the nature of the signal transmitted across the Network Element. Analog impairments are introduced on any analog portion of the loop, typically between the NID portion of Loop Distribution and the analog to digital (A/D) conversion, and are usually correlated with the length of the physical plant. Digital impairments are introduced by A/D conversion and by interfaces between digital Network Elements. In addition, noise can be introduced by either analog transmission or the A/D conversion.

15.2.5.3 Loop Combination Architecture Constraints

15.2.5.3.1 The following constraints will limit not only the variety of Loop Combination architectures that may be considered, but also the architectures BellSouth may consider to deliver any Ancillary Function or Network Element. These constraints apply to the entire path between the NID portion of Loop Distribution and the BellSouth switch. Any exceptions to these restrictions shall be specifically requested or approved by MCIm in writing.

15.2.5.3.1.1 No more than 1 A-D conversion.

15.2.5.3.1.2 No more than 1, 2-to-4-wire hybrid.

15.2.5.3.1.3 No voice compression.

15.2.5.3.1.4 No echo canceled or suppressers.

15.2.5.3.1.5 One digital loss pad per PBX.

15.2.5.3.1.6 No digital gain.

15.2.5.3.1.7 No additional equipment that might significantly increase intermodulation distortion.

#### 15.2.5.4 Transmission Impairments

##### 15.2.5.4.1 Analog Impairments

15.2.5.4.1.1 Analog impairments are those introduced on portions of the end-to-end circuit on which communications signals are transmitted in analog format. These portions of the transmission path would typically be between NID and an A/D conversion, most commonly on the metallic loop. The performance on the analog portion of a circuit is typically inversely proportional to the length of that circuit.

##### 15.2.5.4.1.2 Loss

15.2.5.4.1.2.1 Electrical loss is measured using a 1004 Hz 0.0 DB one Milliwatt 900 ohm test tone.

15.2.5.4.1.2.2 Off-hook electrical loss between the NID and the switch shall be no more than 8.0 dB for any line, and the mean value for all lines shall be 3.5 dB  $\pm$ 0.5 dB. On-hook electrical loss between the NID and the switch shall be

no more than 4.0 dB above the off-hook electrical loss for any line.

#### 15.2.5.4.1.3 Idle Channel Circuit Noise

15.2.5.4.1.3.1 Idle channel circuit noise (C-message) is added by analog facilities, by the A/D conversion of signals, by digital processing equipment (e.g., echo cancelers, digital loss pads), robbed bit signaling, and errors on digital facilities.

15.2.5.4.1.3.2 Idle channel circuit noise shall be less than or equal to 18 dBmC.

#### 15.2.5.4.1.4 Talker Echo

15.2.5.4.1.4.1 The primary source of echo is improper impedance-matching at the 2-to-4 wire hybrid in the BellSouth network. The impact on subscriber perception is a function of both echo return loss and delay.

15.2.5.4.1.4.2 Echo Return Loss (ERL) shall be greater than 26 dB to a standard termination (900 ohms, 2.16  $\mu$ Fd), and greater than 14 dB to a telephone set off-hook. Singing Return Loss (SRL) shall be greater than 21 dB to a standard termination, and greater than 11 dB to a telephone set off-hook.

#### 15.2.5.4.1.5 Listener Echo

Listener echo is a double reflection of a transmitted signal at two different impedance mismatches in the end-to-end connection. While in extreme cases it can degrade voice transmission performance, listener echo is primarily an issue for voiceband data. The requirements on Talker Echo shall apply to Listener Echo.

**15.2.5.4.1.6 Propagation and Processing Delay**

**15.2.5.4.1.6.1** Propagation delay is the delay involved in transmitting information from one location to another. It is caused by processing delays of equipment in the network and delays associated with traveling across transmission facilities.

**15.2.5.4.1.6.2** BellSouth shall cooperate with MCIm to limit total service propagation and processing delay to levels at parity with that within the BellSouth local network.

**15.2.5.4.1.7 Signal-to-Noise Ratio**

**15.2.5.4.1.7.1** The Signal-to-Noise Ratio (S/N) is a critical parameter in determining voiceband data performance. It is typically measured with a 1004 Hz tone.

**15.2.5.4.1.7.2** BellSouth must provide on the Loop Combination a signal-to-noise ratio of at least 37 dB between the NID and the end office.

**15.2.5.4.1.8 C-Notched Noise**

The requirements for Signal-to-Noise Ratio shall apply to C-Notched Noise.

**15.2.5.4.1.9 Attenuation Distortion**

**15.2.5.4.1.9.1** Attenuation distortion, also known as frequency distortion or gain slope, measures the variations in loss at different frequencies across the voice frequency spectrum (200 Hz - 3400 Hz). It is measured by subtracting

the loss at 1004 Hz from the loss at the frequency of interest.

15.2.5.4.1.9.2 Attenuation distortion from the NID to the switch shall be within the range  $\pm 0.5$  dB for frequencies between 304 and 3004 Hz; from the switch to NID attenuation distortion shall be within the range  $\pm 0.5$  dB for frequencies between 204 Hz and 3004 Hz. In addition, attenuation distortion shall remain within the range  $+1$  dB/ $-3$  dB for frequencies between 200 Hz and 3500 Hz.

#### 15.2.5.4.1.10 Envelope Delay Distortion

15.2.5.4.1.10.1 Envelope Delay Distortion (EDD) measures the difference in transit time of signals at different frequencies. EDD is measured relative to the transit time of a 1704 Hz tone, and is given in microseconds. EDD is used as an approximation of the group delay of the channel.

15.2.5.4.1.10.2 EDD shall be: 1704 Hz to 604 Hz —  $\leq 350$   $\mu$ sec.; 1704 Hz to 2804 Hz —  $\leq 195$   $\mu$ sec.; 1704 Hz to 204 Hz —  $\leq 580$   $\mu$ sec.; 1704 Hz to 3404 Hz —  $\leq 400$   $\mu$ sec.

#### 15.2.5.4.1.11 Phase Jitter

15.2.5.4.1.11.1 Phase jitter measures the unwanted angular modulation of a signal. It is caused by noise or the actual modulation of the signal by another unwanted signal. It displaces the zero crossings of a signal. It is measured in terms of peak-to-peak deviations of a 1004 Hz tone from its nominal zero crossings, and in a particular frequency band (200-300 HZ)



and either 4-300 Hz or 2-300 Hz). Phase jitter impacts voiceband data performance and can make modems more susceptible to other impairments, including noise.

15.2.5.4.1.11.2 From the NID to the interexchange carrier point of termination, phase jitter shall be  $< 1.5^\circ$  point-to-point in the 0-300 Hz band, and  $< 1.8^\circ$  point-to-point in the 4-300 Hz band.

#### 15.2.5.4.1.12 Amplitude Jitter

15.2.5.4.1.12.1 Amplitude jitter is any deviation of the peak value of a 1004 Hz signal from its nominal value. Excessive amounts can impair voiceband data performance. It is primarily caused by noise but can also be caused by phase jitter, gain hits, or single frequency interference.

15.2.5.4.1.12.2 In NID-interexchange carrier point of termination,  $\leq 2.5\%$  of amplitude jitter is permitted in the 20-300 Hz band and  $\leq 2.9\%$  in the 4-300 Hz band.

#### 15.2.5.4.1.13 Intermodulation Distortion

15.2.5.4.1.13.1 Intermodulation distortion (IMD) measures non-linear distortions of a signal. It compares the power of harmonic tones to the power of the transmitted tones. It is measured for both the 2nd and 3rd harmonics of the transmitted tones. IMD is caused by compression or clipping and can impair voiceband data performance.

15.2.5.4.1.13.2 Both 2nd and 3rd order IMD between the NID and end office must be  $\geq 52$  dB.

15.2.5.4.1.14 Impulse Noise

15.2.5.4.1.14.1 Impulse noise is a sudden and large increase in noise on a channel for a short duration of time. Impulse noise is measured as a count of the number of times a noise threshold is exceeded during a given time period (typically 5 or 15 minutes). It is caused by protection switching, maintenance activities, electromechanical switching systems, digital transmission errors, and line coding mismatches. Impulse noise sounds like clicking noises or static on voice connections. Impulse noise impairs voiceband data performance.

15.2.5.4.1.14.2 The NID to interexchange carrier point of termination portions of connections shall introduce no impulse noise events within 6 dB of the received signal power on 93% of all 15 minute connections. In addition, there shall be no more than 1 impulse noise event within 6 dB of the received signal power during any 30-minute period.

15.2.5.4.1.15 Phase Hits

15.2.5.4.1.15.1 Phase hits are a sudden change in the phase of a signal lasting at least 4 msec. Phase hits are measured using a threshold which indicates how much the phase of the signal has changed with respect to its nominal phase. Phase hits are caused by protection switching and slips or other synchronization errors. Phase hits can impair voiceband data performance.

15.2.5.4.1.15.2 Between the NID and interexchange carrier point of termination, 99.75% of all 15-minute connections shall have no phase hits exceeding 10°. In addition, there shall be no more than 1 phase hit exceeding 10° in any 30-minute period.

15.2.5.4.1.16 Gain Hits

15.2.5.4.1.16.1 Gain hits are sudden changes in the level of a signal that last at least 4 msec. Gain hits are measured against a threshold of typically 2-5 dB relative to the signal's nominal level. Gain hits are usually caused by protection switches and can impair voiceband data performance.

15.2.5.4.1.16.2 Between the NID and the interexchange carrier point of termination, 99.5% of all 15-minute connections shall have no gain hits exceeding 3 dB. In addition, there shall be no more than 1 gain hit exceeding 3 dB in any 30-minute period.

15.2.5.4.1.17 Dropouts

15.2.5.4.1.17.1 Dropouts are drops in the level of a signal of 12 dB or more for at least 4 msec. They are caused by protection switching events, radio fading, and conditions causing digital carrier systems to lose frame. Dropouts are critical for voiceband data performance but, if severe enough, will also affect voice quality.

15.2.5.4.1.17.2 Between the NID and the interexchange carrier point of termination, 99.9% of all 15-minute connections shall have no dropouts and in addition, no connection shall suffer

more than 1 dropout in any 60-minute period.

#### 15.2.5.4.1.18 Frequency Shift

15.2.5.4.1.18.1 Frequency shift measures any frequency changes that occur when a signal is transmitted across a channel. It is typically measured using a 1004 Hz tone. Frequency shift has very little impact on voice or voiceband data performance; however, round-trip frequency shifts can affect the ability of echo cancelers to remain converged.

15.2.5.4.1.18.2 No more than 0.2 Hz frequency shift shall be on any connection. In addition, 99.5% of all calls shall have frequency shift < 0.1 Hz.

#### 15.2.5.4.1.19 Crosstalk

15.2.5.4.1.19.1 Crosstalk is the presence of signals from other telephone connections on a circuit. Crosstalk can be either intelligible, when speech from other connections can be heard and understood, or unintelligible. Crosstalk is caused by inter-channel interference on the transmission system. Crosstalk is difficult to measure: it requires correlating signals on different circuits or using human listeners to identify its presence. Trouble reports may be used to estimate the probability of crosstalk.

15.2.5.4.1.19.2 99% of Loop Combinations shall have probability  $\leq$  0.1% of experiencing crosstalk exceeding -65 dBm0.

#### 15.2.5.4.1.20 Clipping

15.2.5.4.1.20.1 Clipping occurs when part of a transmitted signal is dropped and does not reach the receiving portion on a connection. It can be caused by Digital Speech Interpolation (DSI) equipment used in Digital Circuit Multiplication Systems (DCMS) which increase the amount of traffic that transmission facilities carry, and by echo cancelers or echo suppressers.

15.2.5.4.1.20.2 No clipping incidents shall occur on any call.

#### 15.2.5.4.2 Digital Impairments

Digital impairments occur in the signal wherever it is transmitted in digital format. These errors are usually introduced upon conversion of the signal from analog to digital, as well as at interfaces between digital components. While many digital impairments have little impact on subjective voice quality, they can impact voiceband data performance.

##### 15.2.5.4.2.1 Signal Correlated Distortion

15.2.5.4.2.1.1 Signal correlated distortion (SCD) is unwanted noise or distortion introduced into a signal through the conversion of a signal from analog to digital format or through digital processing that changes the transmitted signal. SCD affects performance when a sign is being transmitted. The primary sources of SCD are signal encoders, echo cancelers, digital loss pads, and robbed bit signaling. SCD affects both voice and voiceband data performance.

15.2.5.4.2.1.2 The NID-to-end-office connection shall allow:

15.2.5.4.2.1.2.1 A maximum of 1 A/D conversion, using 64 Kbps  $\mu$ -law ( $\mu=255$ ) PCM;

15.2.5.4.2.1.2.2 No voice compression;

15.2.5.4.2.1.2.3 No echo cancellation; and

15.2.5.4.2.1.2.4 Robbed bit signaling only if SS7 or ISDN are not used.

#### 15.2.5.4.2.2 Slips

15.2.5.4.2.2.1 Slips occur when a frame of digital data is either deleted or repeated because of differences in the clocks used to synchronize digital facilities. Slips sound like clicks or pops on voice calls and have major impact on voiceband data performance.

15.2.5.4.2.2.2 The NID-to-interexchange carrier point of termination portion of connections shall have fewer than 0.45 slips every 24 hours on average.

#### 15.2.5.4.2.3 Digital Timing Jitter and Wander

15.2.5.4.2.3.1 Digital timing jitter is the unwanted phase modulation of digital signals at rates above 10 Hz. Wander is the unwanted phase modulation of digital signals at rates below 10 Hz. Digital timing jitter is caused by imperfections in the timing recovery process of repeaters and the stuffing synchronization process used by multiplexer/demultiplexers. Wander is caused by slowly varying changes in digital signal phase due to clock

frequency offset and drift, changes in propagation delay of terrestrial facilities due to temperature changes and changes in the distance of satellites from the earth. These events have a major impact on voiceband data performance.

15.2.5.4.2.3.2 The maximum digital timing jitter allowed in the 10 Hz to 8 kHz frequency band at any network interface or any terminal equipment in the network is 5 Unit Intervals (UI). The maximum digital timing jitter allowed in the 8 kHz to 40 kHz frequency band is 0.1 UI. The objective for wander is less than 28 UI at any network interface or terminal equipment.

#### 15.2.5.4.2.4 DS-1 Errored Seconds

15.2.5.4.2.4.1 An Errored Second (ES) on a DS-1 facility is any second during which at least 1 bit is in error. The impact of an ES on performance depends on the number of errors that occur during a second. Typically, voice performance is not significantly impacted by ES but they can cause errors in voiceband data transmissions.

15.2.5.4.2.4.2 Each BellSouth network shall have less than 20 ESs per 24 hour period.

#### 15.2.5.4.2.5 DS-1 Severely Errored Seconds

15.2.5.4.2.5.1 A severely Errored Second (SES) is any second during which a DS-1 has an error rate exceeding 0.001. An SES can be caused by a loss of framing, a slip, or a protection switch. SESs have impacts on both voice and voiceband data performance. For voice, a SES will

sound like a burst of noise or static. SESs that occur during a voiceband data transmission cause a significant burst of errors and can cause modems to retrain.

15.2.5.4.2.5.2 The digital portion of each NID to POP connection shall have less than 2 SESs per 24 hour period.

#### 15.2.5.4.2.6 Short Failure Events

15.2.5.4.2.6.1 A Short Failure Event (SFE) is a Loss of Frame (LOF) event of less than two minutes' duration. An LOF event is declared when, on detection of a Loss of Signal (LOS) or Out-of-Frame (OOF), a rise-slope-type integration process starts that declares a LOF after  $2.5 \pm 0.5$  sec. of continuous LOS or OOF. If the LOS or OOF is intermittent the integration process shall decay at a slope of 1/5 the rise slope during the period when the signal is normal. Thus, if the ratio of a LOS or OOF to a normal signal is greater than 1/2, a LOF will be declared. A LOS condition shall be declared when the Network Channel Terminating Equipment has determined that  $175 \pm 75$  successive pulse positions with no pulses of either positive or negative polarity have occurred. An OOF condition shall be declared when either Network equipment or Digital Terminal Equipment detects errors in the framing pattern.

15.2.5.4.2.6.2 There shall be fewer than 1 SFE per month.

#### 15.2.5.5 Service Availability and Reliability

Availability refers to the time period during which the service is up and usable for its intended purpose. Reliability refers



to the probability that a task will be completed successfully, given that it is successfully begun.

#### 15.2.5.5.1 Blocked Calls

15.2.5.5.1.1 Blocking is the fraction of call origination attempts denied service during a stated measurement period. Blocking occurs because of competition for limited resources within the network.

15.2.5.5.1.2 For intraLATA toll service and local exchange service, the blocking level from originating (NID) to terminating NID shall not exceed 1% in any hour, except under conditions of service disruption. For access to or egress from a long distance network, the blocking rate shall not exceed 0.5% in any hour.

#### 15.2.5.5.2 Downtime

Downtime is the period of time that a system is in a failed state.

15.2.5.5.2.1 The average downtime for all subscriber Loop Combinations shall be less than 49 minutes per year. The maximum downtime for 99% of all subscriber Loop Combinations shall be less than 74 minutes per year.

15.2.5.5.2.2 The average downtime for an end office switch shall be less than 3 minutes per year. The average downtime for individual trunks shall be less than 28 minutes per year. The average downtime for digital trunk groups shall be less than 20 minutes per year. The average downtime for an individual line appearance at the switch shall be less than 28 minutes per year. The average downtime for a Remote Terminal (RT) shall be less than 17 minutes per year. The average downtime for an individual line on a Remote Terminal (RT) shall be less than 13 minutes per year.

15.2.5.5.2.3 The mean time to repair (MTTR) of any equipment at an attended site shall be less than 3 hours. The mean time to repair (MTTR) of any equipment at an unattended site shall be less than 4 hours. 95% of all repairs to the network interface (NID) shall be completed within 24 hours.

15.2.5.5.2.4 There shall be no downtime due to power failures at the switch.

15.2.5.5.2.5 The probability of a stable call being cut off shall be less than 20 cutoffs per one million 1 minute calls.

15.2.5.5.2.6 The rate of ineffective machine attempts at the end office shall be less than 0.0005 (5 failures per 10,000 call attempts).

15.2.5.5.2.7 BellSouth shall meet all requirements for private line services in TR-NWT-000335, ANSI T1.512-1994.

#### 15.2.5.5.3 Dial Tone Delay

15.2.5.5.3.1 Dial-Tone Delay is the time period between a subscriber off-hook and the receipt of dial tone from an originating end office. Dial-Tone Delay has a significant effect on subscriber opinion of service quality.

15.2.5.5.3.2 The average dial-tone delay shall not exceed 1.5% of calls delayed more than 3 seconds. At most 20% of calls during the high day busy hour (HDBH) shall experience dial-tone delay greater than 3 seconds.

#### 15.2.5.5.4 Dial Tone Removal

15.2.5.5.4.1 Dial tone removal is the time between recognition of the first address digit to the removal of dial tone on the line.

15.2.5.5.4.2 The maximum dial tone removal interval shall be  $\leq 500$  milliseconds.

#### 15.2.5.5.5 Post Dial Delay

15.2.5.5.5.1 Post Dial Delay (PDD) is the amount of time a caller must wait after entering or dialing the last digit of a Destination Telephone Number (DTN) before hearing a valid audible network response. The PDD for an end user is measured from the time the caller has pressed or dialed the last digit of a DTN until receipt of an audible network response.

15.2.5.5.5.2 The requirements given reflect an end-to-end CCS7 protocol for MCI end users. Where a mixture of CCS7 and inband (MF) signaling protocols are employed, an increase in the PDD can be expected.

##### 15.2.5.5.5.2.1 PDD 1 - A - Intra LSO

15.2.5.5.5.2.1.1 Intra-LSO calls do not employ external signaling protocols. The PDD for intra-LSO calls flows are dependent upon the processor cycle time and traffic load conditions. This PDD is assumed to be between subscribers on the same LSO, between the Remote Switch Modules (RSMs) on the same Host, or between an RSM and Host subscribers.

15.2.5.5.5.2.1.2 The objective for intra-LSO PDD is less than 310 milliseconds for 50% of all calls and less than 460 milliseconds for 95% of all calls.

##### 15.2.5.5.5.2.2 PDD1 - B - LSO to Another Local LSO

15.2.5.5.5.2.2.1 The signaling protocols from an LSO to another LSO are assumed to employ out-of-band Common Channel Signaling System 7 (CCS7) format. Local calls, that is, calls from an LSO to another LSOs are assumed to have no more than one pair of Signaling Transfer Point Switches (STPs) and no more than one data base dip.

15.2.5.5.5.2.2.2 This PDD is expected to be better than the MCIT Long Distance objective with an average PDD of  $\leq 8.70$  seconds with 95%  $\leq 1.34$  seconds.

**15.2.5.5.5.2.3 PDD1 - C - MCIm LSO to Other LSO**

15.2.5.5.5.2.3.1 Calls from an MCIm LSO to other LSOs are dependent upon the interface agreements between MCIm and the LSO service provider and may employ CCS7, inband (MF) or a combination of both protocols.

15.2.5.5.5.2.3.2 Calls from an MCIm LSO to another LSO via the Public Switched Telecommunications Network (PSTN), using end-to-end CCS7 signaling protocols, can expect to meet the MCIm PDD objectives of an average of 2.0 seconds with 95% in  $\leq 2.5$  seconds. Calls from an MCIm LSO via the PSTN to LSOs outside the local service area are assumed to use CCS7 signaling protocols to the MCIm switch. The egress signaling protocols from the MCIT Switched Network to the many different local telephone company service

providers however does not necessarily utilize CCS7 signaling. There are three basic egress signaling configuration. They are:

15.2.5.5.2.3.2.1 Network Inter-Connect, CCS7 between MCIm and the local telephone company.

15.2.5.5.2.3.2.2 Inband Multifrequency (MF) signaling protocols without a BellSouth egress tandem in the connection.

15.2.5.5.2.3.2.3 Inband MF signaling protocols with a BellSouth egress tandem in the connection.

15.2.5.5.2.3.2.3.1 Calls from an MCIm LSO to other LSOs outside the local service area are assumed to have multiple STPs for 1+ traffic in the access and PSTN portion of the connection. The egress from the PSTN for 1+ traffic is again dependent upon the interface agreements in that service area and may consist of CCS7 or inband MF protocols.

15.2.5.5.2.3.2.3.2 Calls from an MCIm's LSO to another MCIm LSO with a mixture of CCS7 or all inband signaling protocols are expected to receive PDDs on the average of 2.9 seconds with 95% in  $\leq 6.5$  seconds.

#### 15.2.5.5.2.4 Impact of Number Portability (NP)

If a call forwarding option is used as an interim solution for NP, the delay due to additional switching in the local access shall not exceed 0.4 seconds when MCIm is direct connected to the BellSouth end office, and 0.8 seconds

when MCI<sub>m</sub> is connected to the BellSouth tandem, in addition to the PDDs described above.

**15.2.5.5.5.2.5 Custom Local Area Subscriber Services (CLASS)**

CLASS<sup>SM</sup> features such as Calling Name Delivery can contribute to the PDD of a call. This delay is caused by the additional time (BellSouth option) before the ringing interval commences. This default delay is 3 seconds. Optional settings are available in 1 second intervals from 1 to 6 seconds. Calls to DTNs that have CLASS<sup>SM</sup> features, particularly with calling name delivery, can expect to experience from 1 to 6 seconds (3 seconds default) of additional PDD compared to the PDDs shown for PDD1-C. MCI will specify optimal settings.

**15.2.5.5.5.2.6 Partial Dial Timing**

**15.2.5.5.5.2.6.1** The interval between each information digit from a subscriber's line, until the LSO or switching system has determined that the digit string is incomplete.

**15.2.5.5.5.2.6.2** For subscriber lines, partial dial timing shall be  $\geq 16$  seconds and  $\leq 24$  seconds. For trunks, inband signaling time-out shall be  $\geq 5$  seconds and  $\leq 20$  seconds.

**15.2.5.6 Local Switching**

BellSouth shall provide performance equal to or better than the requirements for Local Switching set forth in Bellcore LSSGR TR-TSY-000511. Post dial delay for connections to MCI<sub>m</sub> local operator services shall be no worse than

Operator Services provided by BellSouth. Additionally, post dial delay from the Operator Services to destination numbers shall be no worse than that provided by BellSouth. Post dial delay for connections to MCIm local directory services shall be no worse than directory services provided by BellSouth. Additionally, post dial delay from the directory system to destination numbers shall be no worse than that provided by BellSouth.

#### 15.2.5.7 Operator Systems

Operator System connections shall comply with the requirements for the Loop Combination, Local Switching, Operator Service, and Directory Assistance Service requirements.

#### 15.2.5.8 Common Transport

Specific requirements for this Network Element or Ancillary Function are in the Common Transport section. In all cases the performance of this Network Element shall meet the general requirements stated in "General Performance Requirements." Allocation of impairments shall be negotiated between MCIm and BellSouth consistent with sound engineering principles.

#### 15.2.5.9 Dedicated Transport

Specific requirements for this Network Element are in the Dedicated Transport section. In all cases the performance of this Network Element shall meet the general requirements stated in "General Performance Requirements." (Allocation of impairments shall be negotiated between MCIm and BellSouth consistent with sound engineering principles.)

#### 15.2.5.10 Signaling Transfer Points

Specific requirements for this Network Element are in the Signaling Transfer Points section. In all cases the performance of this Network Element shall meet the general requirements stated in "General Performance Requirements." (Allocation of impairments shall be negotiated between MCIm and BellSouth.)

#### 15.2.5.11 Signaling Link Transport

Specific requirements for this Network Element are in the Signaling Link Transport section. In all cases the performance of this Network Element shall meet the general requirements stated in "General Performance Requirements." Allocation of impairments shall be negotiated between MCIm and BellSouth consistent with sound engineering principles.

#### 15.2.5.12 SCPs/Databases

The performance requirements for databases (NP, LIDB, E911, etc.) vary depending on the database and the applications it supports. Database-specific performance requirements are included in the sections addressing individual Network Elements and in applicable Bellcore documents. In all cases, the query response time, availability, accuracy, updating capabilities, and other performance parameters shall at least be at parity with those services as provided to BellSouth or other subscriber.

#### 15.2.5.13 Tandem Switching

Specific requirements for this Network Element are in the Tandem Switching section. In all cases the performance of this Network Element shall meet the general requirements stated in "General Performance Requirements." Allocation of impairments shall be negotiated between MCIm and BellSouth consistent with sound engineering principles.

### 15.2.6 Test and Verification

15.2.6.1 BellSouth shall permit MCIm to confirm acceptable performance of any Network Element.

15.2.6.1.1 At MCIm's request, BellSouth will provide access to the Network Element sufficient for MCIm to test the performance of that Network Element to MCIm's satisfaction.

15.2.6.1.2 At MCIm's request, BellSouth will perform tests to confirm acceptable performance and provide MCIm with documentation of test procedures and results acceptable to MCIm.

### 15.3 Protection, Restoration, and Disaster Recovery



**15.3.1 Scope:**

This Section refers specifically to requirements on the use of redundant network equipment and facilities for protection, restoration, and disaster recovery.

**15.3.2 Requirements**

**15.3.2.1** BellSouth shall provide protection, restoration, and disaster recovery capabilities at parity with those capabilities provided for their own services, facilities and equipment (e.g., equivalent circuit pack protection ratios, facility protection ratios).

**15.3.2.2** BellSouth shall provide Network Elements and Ancillary Functions equal priority in protection, restoration, and disaster recovery as provided to their own services, facilities and equipment.

**15.3.2.3** BellSouth shall provide Network Elements and Ancillary Functions equal priority in the use of spare equipment and facilities as provided to their own services, facilities and equipment.

**15.3.2.4** BellSouth shall restore Network Elements which are specific to MCI end user subscribers on a priority basis as MCI may designate.

**15.4 Synchronization**

**15.4.1 Definition:**

Synchronization is the function which keeps all digital equipment in a communications network operating at the same average frequency. With respect to digital transmission, information is coded into discrete pulses. When these pulses are transmitted through a digital communications network, all synchronous Network Elements are traceable to a stable and accurate timing source. Network synchronization is accomplished by timing all synchronous Network Elements in the network to a stratum 1 source so that transmission from these network points have the same average line rate.

**15.4.2 Technical Requirements**

The following requirements are applicable to the case where BellSouth provides synchronization to equipment that MCIm owns and operates within a BellSouth location. In addition, these requirements apply to synchronous equipment that is owned by BellSouth and is used to provide a Network Element to MCIm.

**15.4.2.1** The synchronization of clocks within digital networks is divided into two parts: intra-building and inter-building. Within a building, a single clock is designated as the Building Integrated Timing Supply (BITS), which provides all of the DS1 and DS0 synchronization references required by other clocks in such building. This is referred to as intra-building synchronization. The BITS receives synchronization references from remotely located BITS. Synchronization of BITS between buildings is referred to as inter-building synchronization.

**15.4.2.2** To implement a network synchronization plan, clocks within digital networks are divided into four stratum levels. All clocks in strata 2, 3, and 4 are synchronized to a stratum 1 clock, that is, they are traceable to a stratum 1 clock. A traceable reference is a reference that can be traced back through some number of clocks to a stratum 1 source. Clocks in different strata are distinguished by their free running accuracy or by their stability during trouble conditions such as the loss of all synchronization references.

#### **15.4.2.2.1 Intra-Building**

**15.4.2.2.1.1** Within a building, there may be different kinds of equipment that require synchronization at the DS1 and DS0 rates. Synchronization at the DS1 rate is accomplished by the frequency synchronizing presence of buffer stores at various DSI transmission interfaces. Synchronization at the DS0 rate is accomplished by using a composite clock signal that phase synchronizes the clocks. Equipment requiring DS0 synchronization frequently does not have adequate buffer storage to accommodate the phase variations among different equipment. Control of phase variations to an acceptable level is accomplished by externally timing all

interconnecting DS0 circuits to a single clock source and by limiting the interconnection of DS0 equipment to less than 1,500 cable feet. Therefore, a BITS shall provide DS1 and composite clock signals when the appropriate composite signal is a 64-kHz 5/8<sup>th</sup> duty cycle, return to zero with a bipolar violation every eighth pulse (B8RZ).

#### 15.4.2.2.2 Inter-Building

15.4.2.2.2.1 BellSouth shall provide inter-building synchronization at the DSI rate, and the BITS shall accept the primary and secondary synchronization links from BITS in other buildings. From hierarchical considerations, the BITS shall be the highest stratum clock within the building and BellSouth shall provide operations capabilities (this includes, but is not limited to: synchronization reference provisioning; synchronization reference status inquiries; timing mode status inquiries; and alarm conditions).

#### 15.4.3 Synchronization Distribution Requirements

15.4.3.1 Central office BITS shall contain redundant clocks meeting or exceeding the requirements for a stratum 2 clock as specified in ANSI T1.101-1994 and Bellcore TR-NWT-001244 Clocks for the Synchronized Network: Common Genetic Criteria.

15.4.3.2 Central office BITS shall be powered by primary and backup power sources.

15.4.3.3 If both reference inputs to the BITS are interrupted or in a degraded mode (meaning off frequency greater than twice the minimum accuracy of the BITS, loss of frame, excessive bit errors, or in Alarm Indication Signal), then the stratum clock in the BITS shall provide the necessary bridge in timing to allow the network to operate without a frame repetition or deletion (slip free) with better performance than 1 frame repetition or deletion (slip) per week.

15.4.3.4 DS1s multiplexed into a SONET synchronous payload envelope within an STS-n (where n is defined in ANSI T1.105-1995) signal shall not be used as reference facilities for network synchronization.

15.4.3.5 The total number of Network Elements cascaded from the stratum 1 source shall be minimized.

15.4.3.6 A Network Element shall receive the synchronization reference signal only from another Network Element that contains a clock of equivalent or superior quality (stratum level).

15.4.3.7 BellSouth shall select for synchronization those facilities shown to have the greatest degree of availability (absence of outages).

15.4.3.8 Where possible, all primary and secondary synchronization facilities shall be physically diverse (this means the maximum feasible physical separation of synchronization equipment and cabling).

15.4.3.9 No timing loops shall be formed in any combination of primary and secondary facilities.

15.4.3.10 An Operations Support System (OSS) shall continuously monitor the BITS for synchronization related failures or degradation.

15.4.3.11 An OSS shall continuously monitor all equipment transporting synchronization facilities for synchronization related failures or degradation.

15.4.3.12 For non-SONET equipment, BellSouth shall provide synchronization facilities which, at a minimum, comply with the standards set forth in ANSI T1.101-1994.

15.4.3.13 For SONET equipment, BellSouth shall provide synchronization facilities that have time deviation (TDEV) for integration times greater than 0.05 seconds and less than or equal to 10 seconds, that is less than or equal to 10 nanoseconds. TDEV, in nanoseconds, for integration times greater than 10 seconds and less than 1000 seconds, shall be less than 3.1623 times the square-root of the integration

time. For example, for integration times of 25 seconds, TDEV shall be less than 15.8 nanoseconds.

## 15.5 SS7 Network Interconnection

### 15.5.1.1 Definition:

Figure 8 depicts Signaling System 7 (SS7) Network Interconnection. SS7 Network Interconnection is the interconnection of MCI local Signaling Transfer Point (STPs) with BellSouth STPs. This interconnection provides connectivity that enables the exchange of SS7 messages among BellSouth switching systems and databases (DBs), MCI local or tandem switching systems, and other third-party switching systems directly connected to the BellSouth SS7 network.

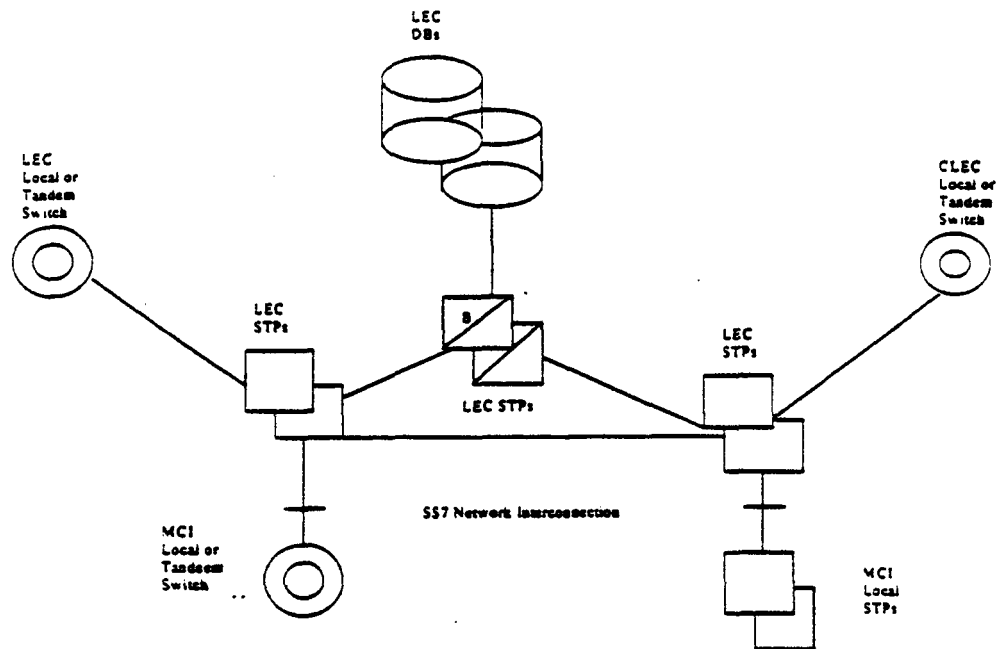

Figure 8. SS7 Network Interconnection

### 15.5.2 Technical Requirements

15.5.2.1 SS7 Network Interconnection shall provide connectivity to all components of the BellSouth SS7 network. These include:

15.5.2.1.1 BellSouth local or tandem switching systems;

15.5.2.1.2 BellSouth DBs; and

15.5.2.1.3 Other third-party local or tandem switching systems.

15.5.2.2 The connectivity provided by SS7 Network Interconnection shall fully support the functions of BellSouth switching systems and DBs and MCI or other third-party switching systems with A-link access to the BellSouth SS7 network.

15.5.2.3 In particular, Figure 9 depicts a circumstance where SS7 Network Interconnection shall provide transport for certain types of Transaction Capabilities Application Part (TCAP) messages. If traffic is routed based on dialed or translated digits between an MCI local switching system and a BellSouth or other third-party local switching system, either directly or via a BellSouth tandem switching system, then it is a requirement that the BellSouth SS7 network convey via SS7 Network Interconnection the TCAP messages that are necessary to provide Call Management services (Automatic Callback, Automatic Recall, and Screening List Editing) between the MCI local STPs and the BellSouth or other third-party local switch.

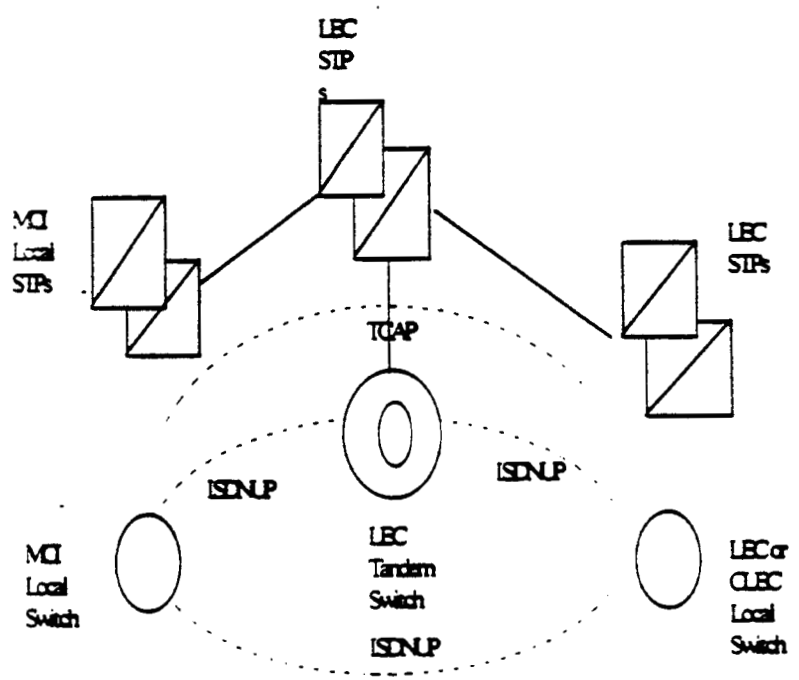

FIGURE 9. Interswitch TCAP Signaling for SS7 Network Interconnection

15.5.2.4 When the capability to route messages based on Intermediate Signaling Network Identifier (ISNI) is generally available on BellSouth STPs, the BellSouth SS7 Network shall also convey TCAP messages using SS7 Network Interconnection in similar circumstances where the BellSouth switch routes traffic based on a Carrier Identification Code (CIC).

15.5.2.5 SS7 Network Interconnection shall provide all functions of the MTP as specified in ANSI T1.111 (Reference 12.5.2). This includes:

15.5.2.5.1 Signaling Data Link functions, as specified in ANSI T1.111.2;

15.5.2.5.2 Signaling Link functions, as specified in ANSI T1.111.3; and

15.5.2.5.3 Signaling Network Management functions, as specified in ANSI T1.111.4.

15.5.2.6 SS7 Network Interconnection shall provide all functions of the SCCP necessary for Class 0 (basic connectionless) service, as specified in ANSI T1.112 (Reference 12.5.4). In particular, this includes Global Title Translation (GTT) and SCCP Management procedures, as specified in T1.112.4.

15.5.2.7 Where the destination signaling point is a BellSouth switching system or DB, or is another third-party local or tandem switching system directly connected to the BellSouth SS7 network, SS7 Network Interconnection shall include final GTT of messages to the destination and SCCP Subsystem Management of the destination.

15.5.2.8 Where the destination signaling point is an MCI local or tandem switching system, SS7 Network Interconnection shall include intermediate GTT of messages to a gateway pair of MCI local STPs, and shall not include SCCP Subsystem Management of the destination.

## **MCImetro-BellSouth Florida Interconnection Agreement**

**15.5.2.9 SS7 Network Interconnection shall provide all functions of the Integrated Services Digital Network User Part (ISDNUP), as specified in ANSI T1.113.**

**15.5.2.10 SS7 Network Interconnection shall provide all functions of the TCAP, as specified in ANSI T1.114.**

**15.5.2.11 If and when Internetwork MTP Routing Verification Test (MRVT) and SCCP Routing Verification Test (SRVT) become approved ANSI standards and available capabilities of BellSouth STPs, SS7 Network Interconnection shall provide these functions of the OMAP.**

**15.5.2.12 SS7 Network Interconnection shall be equal to or better than the following performance requirements:**

**15.5.2.12.1 MTP Performance, as specified in ANSI T1.111.6;**

**15.5.2.12.2 SCCP Performance, as specified in ANSI T1.112.5; and**

**15.5.2.12.3 ISDNUP Performance, as specified in ANSI T1.113.5.**

### **15.5.3 Interface Requirements**

**15.5.3.1 BellSouth shall offer the following SS7 Network Interconnection options to connect MCIm or MCIm-designated STPs to the BellSouth SS7 network:**

**15.5.3.1.1 D-link interface from MCIm STPs.**

**15.5.3.2 Each interface shall be provided by one or more sets (layers) of signaling links, as follows:**



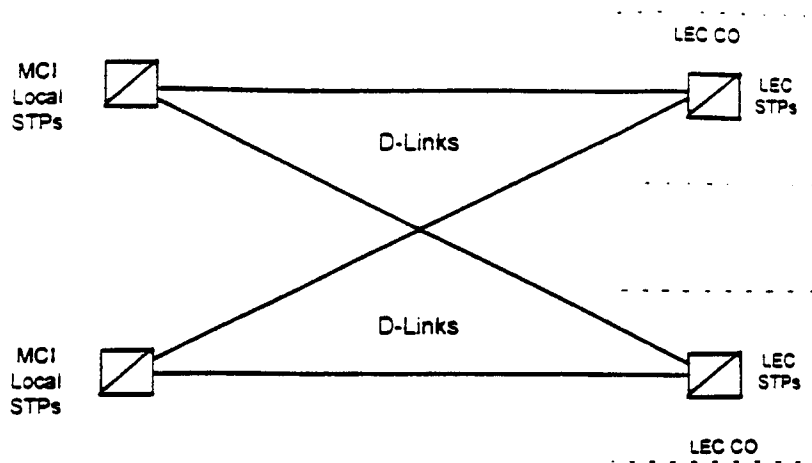

FIGURE 10. D-LINK Interface

15.5.3.3 The Signaling Point of Interconnection (SPOI) for each link shall be located at a cross-connect element, including but not limited to a DSX-1, in the Central Office (CO) where the BellSouth STPs is located. There shall be a DS1 or higher rate transport interface at each of the SPOIs. Each signaling link shall appear as a DS0 channel within the DS1 or higher rate interface. BellSouth shall offer higher rate DS1 signaling links for interconnecting MCI/m local switching systems or STPs with BellSouth STPs as soon as these become approved ANSI standards and available capabilities of BellSouth STPs.

15.5.3.3.1 In each LATA, there will be two signaling points of interconnection (SPOIs). The requirement for two SPOIs is driven by the critical importance attached by all parties to signaling link diversity.

15.5.3.3.2 Each party will designate one of the two SPOIs in the LATA. A SPOI can be any existing cross connect point in the LATA. Since each party will designate a SPOI, we believe that both parties will be incented to select reasonable and efficient SPOI locations.

15.5.3.3.3 Each signaling link requires a port on each party's STP, which each party shall provide without explicit charge.

15.5.3.4 The BellSouth CO shall provide intraoffice diversity between the SPOIs and the BellSouth STPs, so that no single failure of intraoffice facilities or equipment shall cause the failure of both D-links in a layer connecting to a BellSouth STPs.

15.5.3.5 The protocol interface requirements for SS7 Network Interconnection include the MTP, ISDNUP, SCCP and TCAP. These protocol interfaces shall conform to the following specifications:

15.5.3.5.1 Bellcore GR-905-CORE, Common Channel Signaling Network Interface Specification (CCSNIS) Supporting Network Interconnection, Message Transfer Part (MTP), and Integrated Services Digital network User Part (ISDNUP);

15.5.3.5.2 Bellcore GR-1428-CORE, CCS Network Interface Specification (CCSNIS) Supporting Toll Free Service;

15.5.3.5.3 Bellcore GR-1429-CORE, CCS Network Interface Specification (CCSNIS) Supporting Call Management Services; and

15.5.3.5.4 Bellcore GR-1432-CORE, CCS Network Interface Specification (CCSNIS) Supporting Signaling Connection Control Part (SCCP) and Transaction Capabilities Application Part (TCAP).

15.5.3.5 BellSouth shall set message screening parameters to block accept messages from MCI/m local or tandem switching systems destined to any signaling point in the BellSouth SS7 network with which the MCI/m switching system has a legitimate signaling relation.

15.5.4 SS7 Network Interconnection shall be equal to or better than all of the requirements for SS7 Network Interconnection set forth in the following technical references:

15.5.4.1 ANSI T1.110-1992 American National Standard Telecommunications Signaling System Number 7 (SS7) - General Information;

**15.5.4.2 ANSI T1.111-1992 American National Standard for Telecommunications - Signaling System Number 7 (SS7) - Message Transfer Part (MTP);**

**15.5.4.3 ANSI T1.111A-1994 American National Standard for Telecommunications - Signaling System Number 7 (SS7) - Message Transfer Part (MTP) Supplement;**

**15.5.4.4 ANSI T1.112-1992 American National Standard for Telecommunications - Signaling System Number 7 (SS7) - Signaling Connection Control Part (SCCP);**

**15.5.4.5 ANSI T1.113-1995 American National Standard for Telecommunications - Signaling System Number 7 (SS7) - Integrated Services Digital Network (ISDN) User Part;**

**15.5.4.6 ANSI T1.114-1992 American National Standard for Telecommunications - Signaling System Number 7 (SS7) - Transaction Capabilities Application Part (TCAP);**

**15.5.4.7 ANSI T1.115-1990 American National Standard for Telecommunications - Signaling System Number 7 (SS7) - Monitoring and Measurements for Networks;**

**15.5.4.8 ANSI T1.116-1990 American National Standard for Telecommunications - Signaling System Number 7 (SS7) - Operations, Maintenance and Administration Part (OMAP);**

**15.5.4.9 ANSI T1.118-1992 American National Standard for Telecommunications - Signaling System Number 7 (SS7) - Intermediate Signaling Network Identification (ISNI);**

**15.5.4.10 Bellcore GR-905-CORE, Common Channel Signaling Network Interface Specification (CCSNIS) Supporting Network Interconnection, Message Transfer Part (MTP), and Integrated Services Digital Network User Part (ISDNUP);**

**15.5.4.11 Bellcore GR-954-CORE, CCS Network Interface Specification (CCSNIS) Supporting Line Information Database (LIDB) Service;**

**15.5.4.12 Bellcore GR-1428-CORE, CCS Network Interface Specification (CCSNIS) Supporting Toll Free Service;**

15.5.4.13 Bellcore GR-1429-CORE, CCS Network Interface Specification (CCSNIS) Supporting Call Management Services; and,

15.5.4.14 Bellcore GR-1432-CORE, CCS Network Interface Specification (CCSNIS) Supporting Signaling Connection Control Part (SCCP) and Transaction Capabilities Application Part (TCAP).

## 15.6 Network Interconnection

### 15.6.1 Technical Requirements -

15.6.1.1 When requested by MCIm, BellSouth shall provide interconnections between the BellSouth Network Elements provided to MCIm and MCIm's network at transmission rates designated by MCIm.

15.6.1.2 Traffic shall be combined and routed as follows:

15.6.1.2.1 BellSouth shall provide direct trunks for intraLATA traffic (except 911, directory assistance, operator services, and other services that may require special routing) and, at MCIm's request, BellSouth shall allow MCIm to route such traffic either directly to a BellSouth tandem or directly to a BellSouth end-office. At MCIm's option, intraLATA toll and local traffic shall be combined onto one trunk group.

15.6.1.2.2 At MCIm's request, BellSouth shall receive MCIm traffic destined to the BellSouth Operator Systems Network Element, on trunks from an MCIm end-office or an MCIm tandem.

15.6.1.2.3 At MCIm's request, BellSouth shall receive MCIm CAMA-ANI (Centralized Automatic Message Accounting - Automatic Number identification) traffic destined to the BellSouth B911 PSAPs, or E911 tandems, on trunks from an MCIm end-office.

15.6.1.2.4 If and when S911 is being provided by BellSouth, at MCIm's request, BellSouth shall receive MCIm SS7 traffic destined to any BellSouth S911 tandem on trunks from an MCIm end-office.

15.6.1.3 When requested by MCIm and a third party carrier, BellSouth shall provide interconnections between MCIm's network, and the other carrier's network through the BellSouth network at transmission rates designated by MCIm, including, but not limited to DS1, DS3, and STS-1. BellSouth shall combine and route traffic to and from other local carriers and interLATA carriers through the BellSouth network, and at MCIm's request, BellSouth shall record and keep records of such traffic for MCIm billing purposes.

15.6.1.4 BellSouth shall provide two-way trunk groups for interconnections. At MCIm's request, BellSouth shall provide unidirectional traffic on such trunks, in either direction, effectively operating them as if they were one-way trunk groups.

15.6.1.5 BellSouth shall provision trunks without any user restrictions (e.g., option for two-way trunking where mutually agreed to, and no unnecessary trunk group fragmentation by traffic types; provided that the Party receiving the traffic has the right to receive traffic in the manner set forth in Section 1.1.2 of Attachment IV).

15.6.1.6 All trunking provided by BellSouth shall adhere to the applicable performance requirements set forth in the "General Performance Requirements" section of this Agreement.

15.6.1.7 At MCIm's request, BellSouth shall provide for overflow routing from a given trunk group or groups onto another trunk group or groups as MCIm designates.

15.6.1.8 BellSouth and MCIm shall agree on the establishment of two-way trunk groups for the exchange of traffic for other IXCs. These trunk groups can be provided in a "meet point" arrangement.

15.6.1.9 Interconnection shall be made available upon MCIm's request at any Technically Feasible point of interface. All trunk interconnections shall be provided, including, SS7, MF, DTMF, DialPulse, PRI-ISDN (where available), DID (Direct Inward Dialing), CAMA-ANI, and trunking necessary so that interim NP can be provided.

**15.6.1.10 Trunk Interface Requirements**

**15.6.1.10.1 B911/E911 Trunks**

**15.6.1.10.1.1** BellSouth shall allow MCI/m to provide direct trunking to BellSouth E911 tandem. These trunks are to be provided as one-way trunks from a given MCI/m end office to the BellSouth 911 tandem.

**15.6.1.10.2 S911 Trunks**

In areas where S911 tandems are used, BellSouth shall allow MCI/m to provide direct trunking to each BellSouth S911 tandem. Such SS7 trunks are to be provided as one-way trunks from a given MCI/m end-office to the BellSouth S911 tandem.

**15.6.1.10.3 Local Switch and Access Tandem Trunks**

**15.6.1.10.3.1** BellSouth shall provide trunk groups provisioned exclusively to carry intraLATA traffic, as designated by MCI/m.

**15.6.1.10.3.2** BellSouth shall provide trunk groups provisioned exclusively to carry interLATA traffic, as designated by MCI/m.

**15.6.1.10.3.3** BellSouth shall provide SS7 trunks which provide SS7 interconnection. At MCI/m's request, MF trunks may be substituted for SS7 trunks where applicable.

**15.6.1.10.3.4** When and if Technically Feasible, BellSouth shall simultaneously route calls based on dialed digits (in accordance with the standard GR-317-CORE), and Carrier Identification Code (in accordance with the standard GR-394-CORE) over a single SS7 trunk group.

**15.6.1.10.4 BellSouth Operator Services Trunk**

**15.6.1.10.4.1** For traffic from the BellSouth network to MCI/m for Operator Services,

**MCImetro-BellSouth Florida Interconnection Agreement**

**BellSouth shall provide one trunk group per NPA served by the local BellSouth switch.**

**15.6.1.10.4.2 BellSouth shall provide such trunks as one-way trunks from the BellSouth network to the MCIm network.**

**15.6.2 Network Interconnection between BellSouth and MCIm shall meet or exceed all of the requirements for Network Interconnection set forth in the following technical references:**

**15.6.2.1 GR-317-CORE, Switching System generic requirements for Call Control Using the Integrated Services Digital Network User Part (ISDNUP), Bellcore, February, 1994;**

**15.6.2.2 GR-394-CORE, Switching System generic requirements for Interexchange Carrier Interconnection Using the Integrated Services Digital Network User Part (ISDNUP), Bellcore, February, 1994;**

**15.6.2.3 FR-NWT-000271, OSSGR Operator Services Systems generic requirements, Bellcore, 1994 Edition; and**

**15.6.2.4 FR-NWT-000064, LATA Switching Systems Generic Requirements (LSSGR), Bellcore, 1994 Edition.**

***Section 16. Basic 911 and E911***

**See Attachment VIII, Section 6.1.1 911 General Requirements and Section 6.2.1 911 System Interface and Exchanges**

***Section 17. Directory Assistance Data***

**See Attachment VIII, Section 6.1.6, Directory Assistance Data General Requirements and Section 6.2.2, Directory Assistance Data Interfaces and Exchanges.**

**TABLE OF CONTENTS**

**Attachment IV  
INTERCONNECTION**

Section 1.	Local Interconnection Trunk Arrangement	IV - 1
Section 2.	Compensation Mechanisms	IV - 2
Section 3.	Signaling	IV - 4
Section 4.	Network Servicing	IV - 5
Section 5.	Network Management	IV - 8
Section 6.	Busy Line Verify and Interrupt	IV - 9
Section 7.	Usage Measurement	IV - 9
Section 8.	Responsibilities of the Parties	IV - 10



**ATTACHMENT IV**

**INTERCONNECTION**

***Section 1. Local Interconnection Trunk Arrangement***

A. One-way and two-way trunks. The parties may use either one-way or two-way trunking or a combination, as mutually agreed.

1.1 The parties shall initially reciprocally terminate local exchange traffic and IntraLATA/InterLATA toll calls originating on each other's networks as follows:

1.1.1 The parties shall make available to each other either one way or two-way trunks for the reciprocal exchange of combined local traffic and non-equal access IntraLATA toll traffic

1.1.2 Separate two-way trunks will be made available for the exchange of equal-access InterLATA or IntraLATA interexchange traffic that transits BellSouth's network, and local transit traffic to other LECs. Local transit traffic to other LECs shall only be assessed the local interconnection charge.

1.1.3 Separate trunks connecting MCIIm's switch to each 911/E911 tandem.

1.1.4 Separate trunk group connecting MCIIm's switch to BellSouth's operator service center for operator-assisted busy line interrupt/verify. MCIIm, at its option, may establish trunks from its own operator services platform directly to BellSouth's operator service center.

1.1.5 Separate trunk group connecting MCIIm's switch to BellSouth's directory assistance center in instances where MCIIm is purchasing BellSouth's unbundled directory assistance service.

1.1.6 The parties shall attempt to develop a solution whereby local, interLATA and intraLATA traffic may all be combined on a single trunk group.

1.2 Interconnection Point

## MCIm-BellSouth Florida Interconnection Agreement

1.2.1 BellSouth "Interconnection Point" or "IP" means the physical point that establishes the technical interface, the test point, and the operational responsibility hand-off between MCIm and BellSouth for the local interconnection of their networks. MCIm will separate traffic destined for different tandems onto separate trunk groups at the IP.

1.2.2 MCIm shall designate at least one IP in the LATA in which MCIm originates local traffic and interconnects with BellSouth. MCIm will be responsible for engineering and maintaining its network on its side of the IP. BellSouth will be responsible for engineering and maintaining its network on its side of the IP. If and when the parties choose to interconnect at a mid-span meet, MCIm and BellSouth will jointly provision the fiber optic facilities that connect the two networks and shall share the financial and other responsibilities for that facility.

1.2.2.1 Upon MCIm's request for additional points of interconnection, BellSouth will interconnect with MCIm at any Technically Feasible point on BellSouth's network of MCIm's choosing using the same technical configuration or using other arrangements, including but not limited to mutually agreed upon mid-span fiber meets, entrance facilities, telco closets, and physical or virtual collocation.

1.2.2.2 Within three (3) business days of MCIm's written request for IP, BellSouth shall identify any known Environmental Hazard or Hazardous Materials existing in the IP route or location.

1.2.2.3 BellSouth shall allow MCIm to perform any environmental site investigations, including, but not limited to, asbestos surveys, MCIm deems to be necessary in support of its collocation needs, at MCIm's request.

1.2.2.4 If interconnection is complicated by the presence of Environmental Hazards or Hazardous Materials, and an alternative route is available, BellSouth shall make such alternative route available for MCIm's consideration.

## **Section 2. Compensation Mechanisms**

### **2.1 Interconnection Point**

2.1.1 Each party is responsible for bringing their facilities to the IP.

## MCIm-BellSouth Florida Interconnection Agreement

### 2.2 Compensation for Call Traffic Transport and Termination

2.2.1 The Parties shall bill each other reciprocal compensation at the rates set forth for Local Interconnection in this Agreement and the Order of the FPSC. Local Traffic is defined as any telephone call that originates in one exchange and terminates in either the same exchange, or a corresponding Extended Area (EAS) exchange. The terms Exchange and EAS exchanges are defined and specified in Section A3. Of BellSouth's General Subscriber Service Tariff.

2.2.1.1 BellSouth shall provide to MCIm, on diskette(s) or in any other manner that the parties agree to, on a one-time basis when requested by MCIm, an all-inclusive list (BellSouth, LEC, CLEC and EAS NXX's) of NXX's pertaining to section 2.2.1, above, that creates parity with that which BellSouth provides to itself. MCIm may require, upon request, updates to this list.

2.2.2 The IP determines the point at which the originating carrier shall pay the terminating carrier for the completion of that traffic. The following compensation elements shall apply:

2.2.2.1 "Transport", which includes the transmission and any necessary tandem switching of local telecommunications traffic from the interconnection point between the two carriers to the terminating carrier's end-office switch that directly serves the called end-user.

2.2.2.2 "Termination", which includes the switching of Local Traffic at the terminating carrier's end office switch.

2.3 When an MCIm subscriber places a call to BellSouth's subscriber, MCIm will hand off that call to BellSouth at the IP. Conversely, when BellSouth hands over local traffic to MCIm for MCIm to transport and terminate, BellSouth must use the established IP.

2.4 MCIm may designate an IP at any Technically Feasible point including but not limited to any electronic or manual cross-connect points, collocations, telco closets, entrance facilities, and mid-span meets where mutually agreed upon. The transport and termination charges for local traffic flowing through an IP shall be as follows:

## **MCIm-BellSouth Florida Interconnection Agreement**

2.4.1 When calls from MCIm are terminating on BellSouth's network through the BellSouth tandem, MCIm will pay to BellSouth the tandem switching rate.

2.4.2 When BellSouth terminates calls to MCIm's subscribers using MCIm's switch, BellSouth shall pay to MCIm the appropriate interconnection rate(s). BellSouth shall not compensate MCIm for transport and tandem switching unless MCIm actually performs each function.

2.4.3 MCIm may choose to establish direct trunking to any given end office. If MCIm leases trunks from BellSouth, it shall pay charges for dedicated or common transport. For calls terminating from MCIm to subscribers served by these directly trunked end offices, MCIm shall also pay BellSouth the end office switching rate. For BellSouth traffic terminating to MCIm over the direct end office trunking, BellSouth shall pay the same rate.

### ***Section 3. Signaling***

3.1 Signaling protocol. The parties will interconnect their networks using SS7 signaling as defined in GR-317 and GR-394 including ISDN User Part ("ISUP") for trunk signaling and Transaction Capabilities Application Part ("TCAP") for CCS-based features in the interconnection of their networks. All Network Operations Forum (NOF) adopted standards shall be adhered to.

3.2 The parties will provide CCS to each other in conjunction with all trunk groups supporting local, transit, and toll traffic. The parties will cooperate on the exchange of Transactional Capabilities Application Part (TCAP) messages to facilitate full inter-operability of CCS-based features between their respective networks, including all CLASS features and functions. All CCS signaling parameters will be provided including automatic number identification (ANI), originating line information (OLI), calling party category, charge number, etc. All privacy indicators will be honored.

3.2.1 OSS7, while planned by BellSouth, is not presently available.

3.3 Refer to Attachment III, Section 15.5 for detailed terms of SS7 Network Interconnection.

3.4 Both parties agree that the standard interconnection facilities shall be Extended Superframe (ESF) with B8ZS line code. Where ESF/B8ZS is not available, MCIm will agree to using other interconnection protocols on

an interim basis until the standard ESF/B8ZS is available. BellSouth will provide anticipated dates of availability for those areas not currently ESF/B8ZS compatible.

3.4.1 Where MCIm is unwilling to utilize an alternate interconnection protocol, MCIm will provide BellSouth an initial forecast of 64 Kbps Clear Channel Capability ("64K CCC") trunk quantities within 30 days of executing this Agreement, consistent with the forecasting agreements between the parties. Upon receipt of this forecast, the parties will begin joint planning for the engineering, procurement, and installation of the segregated 64K CCC Local Interconnection Trunk Groups, and the associated B8ZS Extended Super Frame ("ESF") facilities, for the sole purpose of transmitting 64K CCC data calls between MCIm and BellSouth. Where additional equipment is required, such equipment would be obtained, engineered, and installed on the same basis and with the same intervals as any similar growth job for IXC, CLEC or ILEC internal subscriber demand for 64K CCC trunks. Where Technically Feasible, these trunks will be established as two-way.

#### **Section 4. Network Servicing**

##### **4.1 Trunk Forecasting:**

4.1.1 The parties shall work towards the development of joint forecasting responsibilities for traffic utilization over trunk groups. Orders for trunks that exceed forecasted quantities for forecasted locations will be accommodated as facilities and or equipment are available. Parties shall make all reasonable efforts and cooperate in good faith to develop alternative solutions to accommodate orders when facilities are not available. Intercompany forecast information must be provided by the parties to each other twice a year. BellSouth's forecast will be provided thirty (30) days following the receipt of the MCIm forecast. The semi-annual forecasts shall include:

4.1.1.1 Yearly forecasted trunk quantities (which include measurements that reflect actual tandem and end office Local Interconnection and future meet point trunks and tandem-subtending Local Interconnection end office equivalent trunk requirements for no more than two years (current plus one year));

4.1.1.2 The use of Common Language Location Identifier (CLLI-MSG), which are described in Bellcore documents BR 795-100-100 and BR 795-400-100;

4.1.1.3 Description of major network projects that affect the other party will be provided in the semi-annual forecasts. Major network projects include but are not limited to trunking or network rearrangements, shifts in anticipated traffic patterns, or other activities by either party that are reflected by a significant increase or decrease in trunking demand for the following forecasting period.

4.1.2 Parties shall meet to review and reconcile their forecasts if forecasts vary significantly. The parties shall mutually agree to the over or under trunk group utilization prior to action being taken on the following;

4.1.2.1 If the parties are unable to reach such a reconciliation, the Local interconnection Trunk Groups shall be provisioned to the higher forecast. At the end of three months, the utilization of the Local Interconnection Trunk Groups will be reviewed and if the average CCS utilization for the third month is under seventy-five percent (75%) of capacity, either party may issue an order to resize the trunk group, which shall be left with not less than twenty-five percent (25%) excess capacity.

4.1.2.2 If the parties agree on the original forecast and then it is determined that a trunk group is under seventy-five percent (75%) of CCS capacity on a monthly-average basis for each month of any six-month period, either party may issue an order to resize the trunk group, which shall be left with not less than twenty-five percent (25%) excess capacity.

4.1.3 Each party shall provide a specified point or points of contact for planning Forecasting and trunk servicing purposes.

4.1.4 Trunking can be established to tandems or end offices or a combination of both via either one-way or two-way trunks. Trunking will be at the DS-0 level, DS-1 level, DS-3/OC-3 level, or higher, as designated by MCI. Initial trunking will be established between the MCI switching centers and BellSouth's access tandem(s). The parties will utilize direct end office trunking under the following conditions:

## **MCIm-BellSouth Florida Interconnection Agreement**

**4.1.4.1 Tandem Exhaust - If a tandem through which the parties are interconnected is unable to, or is forecasted to be unable to, support additional traffic loads for any period of time, the parties will mutually agree on an end office trunking plan that will alleviate the tandem capacity shortage and ensure completion of traffic between MCIm and ILEC subscribers.**

**4.1.4.2 Traffic volume - The parties shall install and retain direct end office trunking sufficient to handle actual or reasonably forecasted traffic volumes, whichever is greater, between an MCIm switching center and a BellSouth end office where the traffic exceeds or is forecast to exceed 220,000 minutes of local traffic per month. The parties will install additional capacity between such points when overflow traffic between the MCIm switching center and ILEC access tandem exceeds or is forecast to exceed 220,000 minutes of local traffic per month.**

**4.1.4.3 Mutual Agreement - The parties may install direct end office trunking upon mutual agreement in the absence of conditions (1) or (2) above and agreement will not unreasonably be withheld.**

### **4.2 Grade Of Service:**

**4.2.1 A blocking standard of one percent (.01) during the average busy hour, as defined by each party's standards, for final trunk groups between a MCIm end office and a BellSouth access tandem carrying meet point traffic shall be maintained. All other final trunk groups are to be engineered with a blocking standard of one percent (.01). Direct end office trunk groups are to be engineered with a blocking standard of one percent (.01). The blocking standard of one half of one percent (.005) will be used on trunk groups carrying interlata traffic.**

**4.2.2 For trunks carrying MCIm interlata traffic, MCIm may request BellSouth to report trunk group service performance and blocking standards to the industry.**

### **4.3 Trunk Servicing**

**4.3.1 Orders between the parties to establish, add, change or disconnect trunks shall be processed by use of an Access Service**

## **MCIm-BellSouth Florida Interconnection Agreement**

Request (ASR), or another industry standard eventually adopted to replace the ASR for local service ordering.

4.3.2 As discussed in this Agreement, both parties will jointly manage the capacity of Local Interconnection Trunk Groups. BellSouth's or MCIm's Trunk Servicing Group will send a Trunk Group Service Request (TGSR) to the other party to trigger changes they desire to the Local Interconnection Trunk Groups based on their capacity assessment. The affected party will issue an ASR to the other party:

4.3.2.1 within ten (10) business days after receipt of the TGSR upon review of and in response to BellSouth's TGSR, or

4.3.2.2 at any time as a result of either party's own capacity management assessment, to begin the provisioning process.

4.3.3 The standard interval used for the provisioning of Local Interconnection Trunk Groups shall be determined by Subscriber Desired Due Date, but in no event shall it be longer than ten (10) working days.

4.3.4 Orders that comprise a major project that directly impacts the other party may be submitted at the same time, and their implementation shall be jointly planned and coordinated. Major projects are those that require the coordination and execution of multiple orders or related activities between and among BellSouth and MCIm work groups, including but not limited to the initial establishment of Local Interconnection or Meet Point trunk groups and service in an area, NXX code moves, re-homes, facility grooming, or network rearrangements.

4.3.5 MCIm and BellSouth agree to exchange escalation lists which reflect contact personnel including vice president-level officers. These lists shall include name, department, title, phone number, and fax number for each person. MCIm and BellSouth agree to exchange an up-to-date list on a quarterly basis.

### ***Section 5. Network Management***

#### **5.1 Protective Protocols**



## MCIm-BellSouth Florida Interconnection Agreement

5.1.1 Either party may use protective network traffic management controls such as 7-digit and 10-digit code gaps on traffic toward each others network, when required to protect the public switched network from congestion due to facility failures, switch congestion or failure or focused overload. MCIm and BellSouth will immediately notify each other of any protective control action planned or executed.

### 5.2 Expansive Protocols

5.2.1 Where the capability exists, originating or terminating traffic reroutes may be implemented by either party to temporarily relieve network congestion due to facility failures or abnormal calling patterns. Reroutes will not be used to circumvent normal trunk servicing. Expansive controls will only be used when mutually agreed to by the parties.

### 5.3 Mass Calling

5.3.1 MCIm and BellSouth shall cooperate and share pre-planning information; where available, regarding cross-network call-ins expected to generate large or focused temporary increases in call volumes, to prevent or mitigate the impact of these events on the public switched network. Parties agree that permanent controls should be in place for NXX's that are dedicated for media stimulated mass calling.

## ***Section 6. Busy Line Verify And Interrupt***

6.1 Description: Each party shall establish procedures whereby its operator bureau will coordinate with the operator bureau of the other party in order to provide Busy Line Verification ("BLV") and Busy Line Verification and Interrupt ("BLVI") services on calls between their respective end users on or before the effective date of this agreement.

6.2 Compensation: Each party shall charge the other party for BLV and BLVI at rates specified in Attachment I.

## ***Section 7. Usage Measurement***

7.1 Each party shall calculate terminating interconnection minutes of use based on standard Automatic Message Accounting (AMA) recordings made within each party's network. These recordings being necessary for each party to generate bills to the other party.

7.2 Measurement of minutes of use over Local Interconnection Trunk groups shall be in actual conversation seconds. The total conversation seconds over each individual Local Interconnection Trunk Group will be totaled for the entire monthly bill-round and then rounded to the next whole minute.

7.3 Where MCIm provides local exchange services via switch facilities, each party shall provide to the other, within 20 calendar days after the end of each BellSouth fiscal quarter (commencing with the first full fiscal quarter after the effective date of this agreement), a usage report with the following information regarding traffic originating from facilities provided by the originating party and terminated over the Local Interconnection Trunk Groups:

7.3.1 Total traffic volume described in terms of minutes and messages and by call type (local, toll, and other) at the state level terminated to each other over the Local Interconnection Trunk Groups and

7.3.2. Percent Local Use (PLU)

#### ***Section 8. Responsibilities Of The Parties***

8.1 BellSouth and MCIm agree to treat each other fairly, nondiscriminatorily, and equally for all items included in this Agreement, or related to the support of items included in this Agreement.

8.2 MCIm and BellSouth agree to exchange such reports and/or data as provided in this Attachment in Section 7.3 to facilitate the proper billing of traffic. Either party may request an audit of such usage reports on no fewer than 10 business days' written notice and any audit shall be accomplished during normal business hours at the office of the party being audited. Such audit must be performed by a mutually agreed-to independent auditor paid for by the party requesting the audit and may include review of the data described in Section 7 above. Such audits shall be requested within six months of having received the PLU factor and usage reports from the other party.

8.3 MCIm and BellSouth will review engineering requirements on a semi-annual basis and establish forecasts for trunk and facilities utilization provided under this Agreement. BellSouth and MCIm will work together to begin providing these forecasts within 30 days from the Effective Date of this Agreement. New trunk groups will be implemented as dictated by engineering requirements for either BellSouth or MCIm.

**MCIm-BellSouth Florida Interconnection Agreement**

**8.4 MCIm and BellSouth shall share responsibility for all Control Office functions for Local Interconnection Trunks and Trunk Groups, and both parties shall share the overall coordination, installation, and maintenance responsibilities for these trunks and trunk groups.**

**8.5 MCIm is responsible for all Control Office functions for the meet point trunking arrangement trunks and trunk groups, and shall be responsible for the overall coordination, installation, and maintenance responsibilities for these trunks and trunk groups.**

**8.6 MCIm and BellSouth shall:**

**8.6.1 Provide trained personnel with adequate and compatible test equipment to work with each other's technicians.**

**8.6.2 Notify each other when there is any change affecting the service requested, including the due date.**

**8.6.3 Coordinate and schedule testing activities of their own personnel, and others as applicable, to ensure its interconnection trunks/trunk groups are installed per the interconnection order, meet agreed-upon acceptance test requirements, and are placed in service by the due date.**

**8.6.4 Perform sectionalization to determine if a trouble is located in its facility or its portion of the interconnection trunks prior to referring the trouble to each other.**

**8.6.5 Advise each other's Control Office if there is an equipment failure which may affect the interconnection trunks.**

**8.6.6 Provide each other with a trouble reporting/repair contact number that is readily accessible and available 24 hours/7 days a week. Any changes to this contact arrangement must be immediately provided to the other party.**

**8.6.7 Provide to each other test-line numbers and access to test lines.**

**8.6.8 Cooperatively plan and implement coordinated repair procedures for the mutually agreed upon meet point and Local Interconnection Trunks and facilities to ensure trouble reports are resolved in a timely and appropriate manner.**

**MCI-BellSouth Florida Interconnection Agreement**

**8.6.9 The parties shall meet and mutually agree to network protocols which include but are not limited to glare parameters, number of digits outpulsed, OZZ codes and 800 CIC codes in use.**

**TABLE OF CONTENTS**

**Attachment V  
COLLOCATION**

Section 1.	Introduction	V-1
Section 2.	Technical Requirements	V-1
Section 3.	License	V-8
Section 4.	Technical References	V-8

## **ATTACHMENT V**

### **COLLOCATION**

#### ***Section 1. Introduction***

This Attachment sets forth the requirements for Collocation.

#### ***Section 2. Technical Requirements***

2.1 BellSouth shall provide space, as requested by MCIm, to meet MCIm's needs for placement of equipment, interconnection, or provision of service.

2.1.1. Within three (3) business days of MCIm's written request, BellSouth shall identify any known Environmental Hazard or Hazardous Materials in the space provided for placement of equipment and interconnection.

2.1.2 BellSouth shall allow MCIm to perform any environmental site investigations, including, but not limited to, asbestos surveys, which MCIm deems to be necessary in support of its collocation needs, at MCIm's expense.

2.1.3 If the space provided for the placement of equipment, interconnection, or provision of service contains environmental contamination or hazardous material, particularly but not limited to asbestos, lead paint or radon, which makes the placement of such equipment or interconnection hazardous, BellSouth shall offer an alternative space, if available, for MCIm's consideration.

2.1.4 MCIm shall provide BellSouth with a list of identified Hazardous Materials which at the time of the request meet the definition of Environmental Hazard in Part B that are contained in any equipment it proposes to place in space provided by BellSouth and must obtain written approval for the installation of such equipment prior to placement of the equipment in the space. Failure to obtain the appropriate written approval from BellSouth prior to placement of equipment represents a breach of this agreement and may result in the loss of MCIm's right to use the space.

MCImetro-BellSouth Florida Interconnection Agreement

2.2 BellSouth shall provide intraoffice facilities (e.g., DS0, DS1, DS3, OC3, OC12, OC48, and STS-1 terminations) as requested by MCIm to meet MCIm's need for placement of equipment, interconnection, or provision of service.

2.3 BellSouth agrees to allow MCIm's employees and designated agents unrestricted access to MCIm dedicated space in manned BellSouth offices twenty-four (24) hours per day each day of the week. BellSouth may place reasonable security restrictions on access by MCIm's employees and designated agents to the MCIm collocated space in unmanned BellSouth offices. Notwithstanding, BellSouth agrees that such space shall be available to MCIm's employees and designated agents twenty-four (24) hours per day each day of the week.

2.3 A security escort may be required for access to BellSouth premises or MCIm space in some locations for non-BellSouth personnel. MCIm agrees to provide its employees who will access the space with a picture identification badge containing the employee name, a recent photograph of the employee and the MCIm company name and/or logo. Agent representatives will be required to have an identification badge containing the representative's name and company name.

2.4 MCIm may collocate the amount and type of equipment it deems necessary in its collocated space in accordance with FCC Rules and Regulations. BellSouth shall not restrict the types of equipment or vendors of equipment to be installed, provided such equipment is for the provision of telecommunications service. All equipment placed in an BellSouth space for collocation must meet applicable industry standards.

2.5 BellSouth shall permit the interconnection of a collocating telecommunications carrier network with that of another collocating telecommunications carrier at the BellSouth premises and the interconnection of collocated equipment to the collocated equipment of another telecommunications carrier within the same premises through the purchase of BellSouth cross-connects.

2.5.1 Subject to Section 2.5, MCIm may choose to lease unbundled transport from the BellSouth, or from a third carrier, rather than construct facilities to the BellSouth central office or facility where equipment will be collocated.

2.5.2 Charges for all services provided pursuant to this Attachment shall be as set forth in Attachment I.

**MCImetro-BellSouth Florida Interconnection Agreement**

**2.6 BellSouth shall permit MCIm to subcontract the construction of cages and the installation of physical collocation equipment arrangements with contractors certified by the BellSouth, provided, however, that the BellSouth shall not unreasonably withhold certification of contractors. Certification by a BellSouth shall be based on the same criteria it uses in approving contractors for its own purposes.**

**2.7 BellSouth shall provide basic telephone service at the tariffed rate for basic service with a connection jack as requested by MCIm from BellSouth for the collocated space. Upon MCIm's request, this service shall be available at the MCIm collocated space on the day that the space is turned over to MCIm by BellSouth.**

**2.8 BellSouth shall provide adequate lighting, ventilation, power, heat, air conditioning, and other environmental conditions for MCIm's space and equipment. These environmental conditions shall adhere to Bell Communication Research (Bellcore) Network Equipment-Building System (NEBS) standards TR-EOP-000063.**

**2.9 BellSouth shall provide access to eyewash stations, shower stations, bathrooms, and drinking water, where available, within the collocated facility on a twenty-four (24) hours per day, seven (7) days per week basis for MCIm personnel and its designated agents.**

**2.10 MCIm may request dual fiber entrance to the BellSouth Central Office. Where dual entrance is available, BellSouth shall provide all ingress and egress of MCIm fiber cabling to MCIm collocated spaces. The specific request for diversity for each site will be provided by MCIm in the collocation application request.**

**2.11 BellSouth shall ensure protection of MCIm's proprietary subscriber information. Any collocation arrangement shall include provisions for BellSouth protecting MCIm's proprietary information.**

**2.12 BellSouth shall participate in and adhere to negotiated service guarantees, and Performance Standards.**

**2.13 BellSouth shall provide MCIm with written notice five (5) business days prior to those instances where BellSouth or its subcontractors may be performing work in the general area of the collocated space occupied by MCIm, or in the general area of the AC and DC power plants which support MCIm equipment that may directly impact MCIm's equipment arrangement, facilities, or power supply. BellSouth will inform MCIm by telephone of such emergency related activity that BellSouth or its subcontractors may be performing in the general area of the collocated**



**MCI metro-BellSouth Florida Interconnection Agreement**

space occupied by MCI, or in the general area of the AC and DC power plants which support MCI equipment that may directly impact MCI's equipment arrangement, facilities or power supply. Notification of any emergency related activity shall be made immediately prior to the start of the activity so that MCI can take any action required to monitor or protect its service.

**2.14 BellSouth shall construct the collocated space in compliance with MCI's collocation request. Any deviation to MCI's request will be jointly negotiated between the parties.**

**2.15 MCI and BellSouth will complete an acceptance walk through of collocated space requested from BellSouth. BellSouth will correct any deviations to MCI's original or jointly amended request within 5 business days after the walk through or a negotiated time frame, depending on the magnitude of the deviation, at BellSouth's expense. Any other additions or changes to the original or jointly amended request will be at MCI's expense.**

**2.16 BellSouth shall provide Telephone Equipment drawings depicting the exact location for BellSouth Point of Termination Bay(s) to MCI at the first joint planning meeting.**

**2.17 A joint planning meeting between BellSouth and MCI will commence within a maximum of seven (7) business days, unless the parties jointly agree upon a later date, from BellSouth's receipt of a complete and accurate firm order and the payment of agreed upon fees. The following information will be exchanged or determined at the meeting.**

**2.17.1 Telephone equipment drawings depicting the exact path with dimensions for MCI Outside Plant Fiber ingress and egress into collocated space.**

**2.17.2 BellSouth shall provide power cabling connectivity information including the sizes and number of power feeders and power feeder fuse slot assignment on the BellSouth BDFB.**

**2.17.3 Work restriction guidelines.**

**2.17.4 BellSouth contacts and escalation process (names and telephone numbers and escalation order) for the following areas:**

**Engineering  
Provisioning  
Billing**

## MCImetro-BellSouth Florida Interconnection Agreement

Operations  
Physical & Logical Security  
Site and Building Managers  
Environmental and Safety

2.17.5 The target date for the release of BellSouth engineering documents which shall include, but not be limited to, connector type, number and type of pairs, and naming convention.

2.17.6 Target commencement date, which shall be the date MCI's equipment is turned up and operational on the BellSouth network.

2.18 Left blank intentionally

2.19 Left blank intentionally

2.20 MCI shall be compensated by BellSouth for any delays in the negotiated completion and turnover dates which create expenditures for MCI. MCI will be reimbursed in the amount equal to the MCI expenditures incurred as a direct result of delays created by BellSouth. Such expenditures may include items such as lease extension penalties incurred when MCI could not vacate a leased property on or by the central office space availability date originally committed by BellSouth, as a result of delays on BellSouth's part.

2.21 MCI agrees to place operational telecommunications equipment in the BellSouth premises and connect with BellSouth's network within one hundred eighty (180) days of the space turnover date, unless the parties mutually agree to extend such timeframe. MCI forfeits its rights to use the space on the thirtieth day after BellSouth provides MCI written notice of such failure if MCI does not place operational telecommunications equipment in the premises and connect with BellSouth's network by such thirtieth day. In any such event, MCI shall be liable in an amount equal to the unpaid balance of the preparation charges due pursuant to Section 2.17 of this Attachment.

2.22 Power as referenced in this document refers to any electrical power source supplied by BellSouth for MCI equipment. It includes all superstructure, infrastructure, and overhead facilities, including, but not limited to, cable, cable racks and bus bars. BellSouth will supply power to support MCI equipment at equipment specific DC and AC voltages. BellSouth shall supply power to MCI at parity with that provided by BellSouth to itself or to any third party. If BellSouth performance, availability, or restoration falls below industry standards, BellSouth shall

bring itself into compliance with such industry standards as soon as technologically feasible.

**2.22.1** Central office power supplied by BellSouth into the MCIm equipment area, shall be supplied in the form of power feeders (cables) on cable racking into the designated MCIm equipment area. MCIm's certified vendor shall be responsible for the installation of power cabling from BellSouth's power distribution frame associated with the collocation space to the designated MCIm equipment area. The power feeders (cables) shall efficiently and economically support the requested quantity and capacity of MCIm equipment. The termination location shall be as requested by MCIm. Any deviations will be jointly negotiated by BellSouth and MCIm.

**2.22.2** BellSouth shall provide power as requested by MCIm to meet MCIm's need for placement of equipment, interconnection, or provision of service.

**2.22.3** BellSouth power equipment supporting MCIm's equipment shall:

**2.22.3.1** Comply with applicable industry standards (e.g., Bellcore and NEBS) or manufacturer's equipment power requirement specifications for equipment installation and physical equipment layout;

**2.22.3.2** Have redundant power feeds with physical diversity and battery back-up at parity with that provided for similar BellSouth equipment;

**2.22.3.3** Provide, upon MCIm's request via the BFR process, the capability for real time access to performance monitoring and alarm data that impacts (or potentially may impact) MCIm traffic;

**2.22.3.4** Provide central office ground, connected to a ground electrode located within the MCIm collocated space, at a location which meets BellSouth's Standards and is jointly agreed upon by the parties at the initial planning meeting identified in Section 2.17 preceding of this Attachment V.

**2.22.3.5** Provide feeder capacity and quantity to support the ultimate equipment layout for MCIm equipment in

**MCImetro-BellSouth Florida Interconnection Agreement**

accordance with MCIm's collocation request.

**2.22.3.6 BellSouth shall, within ten (10) days of MCIm's request:**

**2.22.3.6.1 Permit MCIm to inspect supporting documents for contracted work done on behalf of MCIm (i.e. AIA document G702);**

**2.22.3.6.2 Provide an installation sequence and access that will allow installation efforts in parallel without jeopardizing personnel safety or existing MCIm services;**

**2.22.3.6.3 Provide power plant alarms that adhere to Bell Communication Research (Bellcore) Network Equipment-Building System (NEBS) standards TR-EOP-000063, upon MCIm's request via the BFR process;**

**2.22.3.6.4 Provide cabling that adheres to Bell Communication Research (Bellcore) Network Equipment-Building System (NEBS) standards TR-EOP-000063;**

**2.22.3.6.5 Provide Lock Out-Tag Out and other electrical safety procedures and devices in conformance with the most stringent of OSHA or industry guidelines.**

**2.22.4 BellSouth will provide MCIm with written notification within ten (10) business days of any scheduled AC or DC power work or related activity in the collocated facility that will or might cause an outage or any type of power disruption to MCIm equipment located in BellSouth facility. BellSouth shall provide MCIm immediate notification by telephone of any emergency power activity that would impact MCIm equipment.**

**2.23 BellSouth shall provide virtual collocation where physical collocation is not practical for technical reasons or because of space limitations. BellSouth shall take collocater demand into account when renovating existing facilities and constructing or leasing new facilities.**

**2.24 Unless abatement of an Environmental Hazard or Hazardous**

## MCImetro-BellSouth Florida Interconnection Agreement

Materials is required, intervals for physical collocation shall be a maximum of ninety (90) days from the date BellSouth receives MCIm's firm order request. Requirements, terms and conditions for virtual collocation will be pursuant to section 20 of BellSouth's FCC #1 tariff.

2.25 Insurance requirements for collocation are subject to the provisions of section 11.7 of Part A of this Agreement.

### ***Section 3. License - Left Blank Intentionally***

### ***Section 4. Technical References***

BellSouth agrees to comply with all Bellcore and ANSI standards that are directly applicable to construct, supply and maintain collocation facilities. Such standards may include, without limitation:

National Electrical Code (NEC)  
NEBS Generic Engineering Requirements for System Assembly and  
Cable Distribution (Bellcore)  
Generic Requirements for -24, -48, -130, and -140 volt central office  
power plant rectifiers (Bellcore)

**ATTACHMENT VI**

**Rights of Way (ROW), Conduits, and Pole Attachments**

**TABLE OF CONTENTS**

1. RIGHTS OF WAY (ROW), CONDUITS AND POLE ATTACHMENTS	1
2. UNUSED TRANSMISSION MEDIA	39

## Attachment VI

### Rights of Way (ROW), Conduits, and Pole Attachments

#### 1. RIGHTS OF WAY (ROW), CONDUITS AND POLE ATTACHMENTS

This Attachment sets forth the terms and conditions under which BellSouth shall afford to MCIm access to BellSouth's poles, ducts, conduits and rights-of-way, pursuant to the Act.

##### 1.1 DEFINITIONS

1.1.1 Definitions in General. Except as the context otherwise requires, the terms defined in this Attachment shall, as used in this Attachment, have the meanings set forth in 1.1.2 through 1.1.30.

1.1.2 Anchor. The term "anchor" refers to a device, structure, or assembly which stabilizes a pole and holds it in place. An anchor assembly may consist of a rod and fixed object or plate, typically embedded in the ground, which is attached to a guy strand or guy wire, which, in turn, is attached to the pole. The term "anchor" does not include the guy strand which connects the anchor to the pole and includes only those anchors which are owned by BellSouth, as distinguished from anchors which are owned and controlled by other persons or entities.

1.1.3 Anchor/guy strand. The term "anchor/guy strand" refers to supporting wires, typically stranded together, or other devices attached to a pole and connecting that pole to an anchor or to another pole for the purpose of increasing pole stability. The term "anchor/guy strand" includes, but is not limited to, strands sometimes referred to as "anchor strands," "down guys," "guy strands," and "pole-to-pole guys."

1.1.4 Communications Act of 1934. The terms "Communications Act of 1934" and "Communications Act" refer to the Communications Act of June 19, 1934, 48 Stat. 1064, as amended, including the provisions codified as 47 U.S.C. Sections 151 et seq. The Communications Act includes the Pole Attachment Act of 1978, as defined in this Section 1.1.

1.1.5 Assigned. The term "assigned", when used with respect to conduit or duct space or pole attachment space, refers to any space in such conduit or duct or on such pole that is occupied by a telecommunications service provider or a municipal or other governmental authority or is assigned pursuant to Section 1.5.5

herein. To ensure the judicious use of poles and conduits, space "assigned" to a telecommunications service provider must be physically occupied by the service provider, be it BellSouth or a new entrant, within twelve (12) months of the space being "assigned".

1.1.6 Available. The term "available", when used with respect to conduit or duct space or pole attachment space, refers to any usable space in such conduit or duct or on such pole not assigned to a specific provider at the applicable time.

1.1.7 Conduit occupancy. The terms "conduit occupancy" and "occupancy" refer to the presence of wire, cable, optical conductors, or other facilities within any portion of BellSouth's conduit system.

1.1.8 Conduit system. The term "conduit system" refers to any combination of ducts, conduits, manholes, and handholes joined to form an integrated whole. In this Attachment, the term refers to conduit systems owned or controlled by BellSouth.

1.1.9 Cost. The term "cost" as used herein refers to charges made by BellSouth to MCIm for specific work performed, and shall be (a) the actual charges made by subcontractors to BellSouth for work and/or, (b) if the work was performed by BellSouth employees, the rates set forth in Attachment I of this Agreement shall apply for such work.

1.1.10 Duct. The term "duct" refers to a single enclosed tube, pipe, or channel for enclosing and carrying cables, wires, and other facilities. As used in this Attachment, the term "duct" includes "inner ducts" created by subdividing a duct into smaller channels.

1.1.11 Facilities. The terms "facility" and "facilities" refer to any property or equipment utilized in the provision of telecommunication services.

1.1.12 The acronym "FCC" refers to the Federal Communications Commission.

1.1.13 Inner-Duct. The term "inner-duct" refers to a pathway created by subdividing a duct into smaller channels.

1.1.14 Joint User. The term "joint user" refers to a utility which has entered into an agreement with SBT providing reciprocal rights of attachment of facilities owned by each party to the poles, ducts, conduits and rights-of-way owned by the other party.



1.1.15 Licensee. The term "licensee" refers to a person or entity which has entered or may enter into an agreement or arrangement with BellSouth permitting such person or entity to place its facilities in BellSouth's conduit system or attach its facilities to BellSouth's poles or anchors.

1.1.16 Lashing. The term "lashing" refers to the attachment of a licensee's sheath or inner-duct to a supporting strand.

1.1.17 License. The term "license" refers to any license issued pursuant to this Agreement and may, if the context requires, refer to conduit occupancy or pole attachment licenses issued by BellSouth prior to the date of this Agreement.

1.1.18 Make-Ready work. The term "make-ready work" refers to all work performed or to be performed to prepare BellSouth's conduit systems, poles or anchors and related facilities for the requested occupancy or attachment of MCIm's facilities. "Make-Ready work" includes, but is not limited to, clearing obstructions (e.g., by "rodding" ducts to ensure clear passage), the rearrangement, transfer, replacement, and removal of existing facilities on a pole or in a conduit system where such work is required solely to accommodate MCIm's facilities and not to meet BellSouth's business needs or convenience. "Make-Ready work" may require "dig-ups" of existing facilities and may include the repair, enlargement or modification of BellSouth's facilities (including, but not limited to, conduits, ducts, handholes and manholes) or the performance of other work required to make a pole, anchor, conduit or duct usable for the initial placement of MCIm's facilities.

1.1.19 Manhole/Handhole. The term "manhole" refers to an enclosure, usually below ground level and entered through a hole on the surface covered with a cast iron or concrete manhole cover, which personnel may enter and use for the purpose of installing, operating, and maintaining facilities in a conduit. The term "handhole" refers to a similar enclosure which is too small for personnel to enter.

1.1.20 Occupancy. The term "occupancy" shall refer to the physical presence of telecommunication facilities in a duct, on a pole, or within a right-of-way.

1.1.21 Person acting on MCIm's behalf. The terms "person acting on MCIm's behalf," "personnel performing work on MCIm's behalf," and similar terms include both natural persons and firms and

ventures of every type, including, but not limited to, corporations, partnerships, limited liability companies, sole proprietorships, and joint ventures. The terms "person acting on MCIm's behalf," "personnel performing work on MCIm's behalf," and similar terms specifically include, but are not limited to, MCIm, its officers, directors, employees, agents, representatives, attorneys, contractors, subcontractors, and other persons or entities performing services at the request of or as directed by MCIm and their respective officers, directors, employees, agents, and representatives.

**1.1.22 Person acting on BellSouth's behalf.** The terms "person acting on BellSouth's behalf," "personnel performing work on BellSouth's behalf," and similar terms include both natural persons and firms and ventures of every type, including but not limited to corporations, partnerships, limited liability companies, sole proprietorships, and joint ventures. The terms "person acting on BellSouth's behalf," "personnel performing work on BellSouth's behalf," and similar terms specifically include, but are not limited to, BellSouth, its officers, directors, employees, agents, representatives, attorneys, contractors, subcontractors, and other persons or entities performing services at the request or on behalf of BellSouth and their respective officers, directors, employees, agents, and representatives.

**1.1.23 Pole.** The term "pole" refers to both utility poles and anchors but only to those utility poles and anchors owned or controlled by BellSouth, and does not include utility poles or anchors with respect to which BellSouth has no legal authority to permit attachments by other persons or entities.

**1.1.24 Pole Attachment Act.** The terms "Pole Attachment Act" and "Pole Attachment Act of 1978" refer to those provisions of the Communications Act of 1934, as amended, now codified as 47 U.S.C. ' 224.

**1.1.25 Prelicense survey.** The term "prelicense survey" refers to all work and activities performed or to be performed to determine whether there is adequate capacity on a pole or in a conduit or conduit system (including manholes and handholes) to accommodate MCIm's facilities and to determine what make-ready work, if any, is required to prepare the pole, conduit or conduit system to accommodate MCIm's facilities.

**1.1.26 Right of Way (ROW).** The term "right of way" refers to the right to use the land or other property of another party to place

poles, conduits, cables, other structures and equipment, or to provide passage to access such structures and equipment. A Right of Way may run under, on, or above public or private property (including air space above public or private property) and may include the right to use discrete space in buildings, building complexes, or other locations.

1.1.27 Sheath. The term "sheath" refers to a single outer covering containing communications wires, fibers, or other communications media.

1.1.28 Spare Capacity. The term "spare capacity" refers to any pole attachment space, conduit, duct or inner-duct not currently assigned or subject to a pending application for attachment/occupancy. Spare capacity does not include an inner-duct (not to exceed one inner -duct per party) reserved by BellSouth, MCIm, or a third party for maintenance, repair, or emergency restoration.

1.1.29 State. When capitalized, the term "State" (as used in terms such as "this State") refers to the State of Florida.

1.1.30 Third Party. The terms "third party" and "third parties" refer to persons and entities other than MCIm and BellSouth. Use of the term "third party" does not signify that any such person or entity is a party to this Agreement or has any contractual rights hereunder.

## 1.2 SCOPE OF ATTACHMENT

1.2.1 Scope of Attachment. BellSouth shall provide MCIm with equal and nondiscriminatory access to pole space, conduits, ducts, and rights-of-way on terms and conditions equal to those provided by BellSouth to itself or to any other telecommunications service provider. Further, BellSouth shall not withhold or delay assignment of such facilities to MCIm because of the potential or forecasted needs of itself or other parties.

1.2.2 Attachments and Occupancies Authorized by this Attachment. BellSouth shall issue one or more licenses to MCIm authorizing MCIm to attach facilities to BellSouth's owned or controlled poles and to place facilities within BellSouth's owned or controlled conduits, ducts or rights-of-way under the terms and conditions set forth in this Attachment and the Telecommunications Act of 1996.

1.2.2.1 Unless otherwise provided herein, authority to

attach facilities to BellSouth's owned or controlled poles, to place facilities within BellSouth's owned or controlled conduits, ducts or rights-of-way shall be granted only in individual licenses granted under this Attachment and the placement or use of such facilities shall be determined in accordance with such licenses and procedures established in this Attachment.

1.2.2.2 MCIm agrees that its attachment of facilities to BellSouth's owned or controlled poles, occupancy of BellSouth's owned or controlled conduits, ducts or rights-of-way shall take place pursuant to the licensing procedures set forth herein, and BellSouth agrees that it shall not unreasonably withhold or delay issuance of such licenses.

1.2.3 Licenses. Subject to the terms and conditions set forth in this Attachment, BellSouth shall issue to MCIm one or more licenses authorizing MCIm to place or attach facilities in or to specified poles, conduits, ducts or rights-of-way owned or controlled by BellSouth located within this State on a first come, first served basis. If BellSouth determines that the pole, conduit or duct space specifically requested by MCIm is necessary to meet BellSouth's present needs, or is licensed by BellSouth to another licensee, or is otherwise unavailable based on engineering concerns, BellSouth shall have the right to designate the particular duct(s) to be occupied, the location and manner in which MCIm's facilities will enter and exit BellSouth's conduit system and the specific location and manner of installation for any associated equipment which is permitted by BellSouth to occupy the conduit system, provided that BellSouth shall provide written notice to MCIm within a reasonable time specifying in detail the reasons for denying MCIm's request. If MCIm disagrees with BellSouth's determination, the matter may be submitted to the Alternative Dispute Resolution Process described in Part A of this Agreement

1.2.4 Access and Use of Rights-of-Way. BellSouth acknowledges that it is required by the Telecommunications Act of 1996 to afford MCIm access to and use of all associated rights-of-way to any sites where BellSouth's owned or controlled poles, manholes, conduits, ducts or other parts of BellSouth's owned or controlled conduit systems are located and any other owned or controlled ROW.

1.2.4.1 BellSouth shall provide MCIm with access to and use of such rights-of-way to the same extent and for the same purposes that BellSouth may access or use such

rights-of-way, including but not limited to access for ingress, egress or other access and to construct, utilize, maintain, modify, and remove facilities for which pole attachment, conduit occupancy, or ROW use licenses have been issued, provided that any agreement with a third party under which BellSouth holds such rights expressly or impliedly grants BellSouth the right to provide such rights to others.

1.2.4.2 Where BellSouth notifies MCIm that a BellSouth agreement with a third party does not expressly or impliedly grant BellSouth the ability to provide such access and use rights to others, upon MCIm's request, BellSouth will use its best efforts to obtain the owner's consent and to otherwise secure such rights for MCIm. MCIm agrees to reimburse BellSouth for the reasonable and demonstrable costs incurred by BellSouth in obtaining such rights for MCIm.

1.2.4.3 In cases where a third party agreement does not grant BellSouth the right to provide access and use rights to others as contemplated in 1.2.4.1 and BellSouth, despite its best efforts, is unable to secure such access and use rights for MCIm in accordance with 1.2.4.2, or, in the case where MCIm elects not to invoke its rights under 1.2.4.1 or 1.2.4.2, MCIm shall be responsible for obtaining such permission to access and use such rights-of-way. BellSouth shall cooperate with MCIm in obtaining such permission and shall not prevent or delay any third party assignment of ROWs to MCIm.

1.2.4.4 Where BellSouth has any ownership or rights-of-way to buildings or building complexes, or within buildings or building complexes, BellSouth shall offer to MCIm through a license or other agreement:

1.2.4.4.1 The right to use any available space owned or controlled by BellSouth in the building or building complex to install MCIm equipment and facilities; and

1.2.4.4.2 Ingress and egress to such space.

1.2.5 Except to the extent necessary to meet the requirements of the Telecommunications Act of 1996, neither this Attachment nor any license granted hereunder shall constitute a conveyance or assignment of any of either party's rights to use any public or private rights-of-way, and nothing contained in this Attachment or in any license granted hereunder shall be construed as conferring on

one party any right to interfere with the other party's access to any such public or private rights-of-way.

**1.2.6 Left Blank Intentionally**

**1.2.7 No Effect on BellSouth's Rights to Manage its Own Facilities.**

This Attachment shall not be construed as limiting or interfering with BellSouth's rights set forth below, except to the extent expressly provided by the provisions of this Attachment or licenses issued hereunder or by the Telecommunications Act of 1996 or other applicable laws, rules or regulations:

**1.2.7.1 To locate, relocate, move, replace, modify, maintain, and operate BellSouth's own facilities within BellSouth's conduits, ducts or rights-of way or any of BellSouth's facilities attached to BellSouth's poles at any time and in any reasonable manner which BellSouth deems appropriate to serve its customers, avail itself of new business opportunities, or otherwise meet its business needs; or**

**1.2.7.2 To enter into new agreements or arrangements with other persons or entities permitting them to attach or place their facilities to or in BellSouth's poles, conduits or ducts; provided, however, that such relocations, moves, replacements, modifications, maintenance and operations or new agreements or arrangements shall not substantially interfere with MCIm's pole attachment, conduit occupancy or ROW use, rights provided by licenses issued pursuant to this Attachment .**

**1.2.8 No Effect on MCIm's Rights to Manage its Own Facilities.**

This Attachment shall not be construed as limiting or interfering with MCIm's rights set forth below, except to the extent expressly provided by the provisions of this Attachment or licenses issued hereunder or by the Telecommunications Act of 1996 or other applicable laws, rules or regulations:

**1.2.8.1 To locate, relocate, move, replace, modify, maintain, and operate its own facilities within BellSouth's conduits, ducts or rights-of-way or its facilities attached to BellSouth's poles at any time and in any reasonable manner which MCIm deems appropriate to serve its customers, avail itself of new business opportunities, or otherwise meet its business needs; or**

**1.2.8.2 To enter into new agreements or arrangements with other persons or entities permitting MCIm to attach or place**

its facilities to or in such other persons' or entities' poles, conduits or ducts, or rights-of-way; provided, however, that such relocations, moves, replacements, modifications, maintenance and operations or new agreements or arrangements shall not conflict with MCIm's obligations under licenses issued pursuant to this Attachment .

**1.2.9 No Right to Interfere with Facilities of Others.** The provisions of this Attachment or any license issued hereunder shall not be construed as authorizing either party to this Attachment to rearrange or interfere in any way with any of the other party's facilities, with the facilities of other persons or entities, or with the use of or access to such facilities by such other party or such other persons or entities, except to the extent expressly provided by the provisions of this Attachment or any license issued hereunder or by the Telecommunications Act of 1996 or other applicable laws, rules or regulations.

**1.2.9.1** MCIm acknowledges that the facilities of persons or entities other than BellSouth and MCIm may be attached to or occupy BellSouth's poles, conduits, ducts and rights-of-way.

**1.2.9.2** BellSouth shall not attach, or give permission to any third parties to attach facilities to, existing MCIm facilities without MCIm's prior written consent. If BellSouth becomes aware of any such unauthorized attachment to MCIm facilities, BellSouth shall use its best efforts to rectify the situation as soon as practicable.

**1.2.9.3** With respect to facilities occupied by MCIm or the subject of an application for attachment by MCIm, BellSouth will give to MCIm 60 days' written notice for conduit extensions or reinforcements, 60 days' written notice for pole line extensions, 60 days' written notice for pole replacements, and 60 days' written notice of BellSouth's intention to construct, reconstruct, expand or place such facilities or of BellSouth's intention not to maintain or use any existing facility and, in the case of an existing facility which BellSouth elects not to maintain or use, BellSouth will grant to MCIm a right to maintain and use such facility. If an emergency or provision or an applicable joint use agreement requires BellSouth to construct, reconstruct, expand or replace poles, conduits or ducts occupied by MCIm or the subject of an application for attachment by MCIm, BellSouth will notify MCIm as soon as reasonably practicable of such

proposed construction, reconstruction, expansion or replacement to enable MCIm, if it so desires, to request that a pole, conduit or duct of greater height or capacity be utilized to accommodate an anticipated facility need of MCIm.

1.2.9.4 At MCIm's expense, BellSouth shall remove any retired cable from conduit systems to allow for the efficient use of conduit space within a reasonable period of time.

1.2.9.5 BellSouth will allow MCIm and other parties to reserve capacity under the same time frames, terms and conditions that it affords itself. This includes reservation of emergency ducts as well as ducts for growth and other purposes.

MCIm, if it so chooses may reserve one emergency duct for itself and then offer to share this duct with other telecommunication carriers that are willing to enter into such a sharing agreement.

1.2.10 Assignment of Space. Assignment of space on poles, in conduits or ducts and within ROWs will be granted by BellSouth on an equal basis to BellSouth, MCIm and other telecommunication service providers.

### 1.3 REQUIREMENTS AND SPECIFICATIONS

1.3.1 Published Standards Incorporated in this Attachment by Reference. MCIm agrees that its facilities shall be placed, constructed, maintained, repaired, and removed in accordance with current (as of the date when such work is performed) editions of the following publications, each of which is incorporated by reference as part of this Attachment :

1.3.1.1 The Blue Book Manual of Construction Procedures, Special Report SR-TAP-001421, published by Bell Communications Research, Inc. ("Bellcore"), and sometimes referred to as the "Blue Book";

1.3.1.2 The National Electrical Code (NEC); and

1.3.1.3 The National Electrical Safety Code (NESC).

1.3.2 Changes in Published Standards. MCIm agrees to rearrange its facilities in accordance with changes in the standards published in the publications specified in Section 1.3 of this



Attachment if required by law to do so or upon the mutual agreement of the parties.

**1.3.3 Additional Electrical Design Specifications.** MCIm agrees that, in addition to specifications and requirements referred to in Articles 1.3.1-1.3.2 above, MCIm's facilities placed in BellSouth's conduit system shall meet all of the following electrical design specifications:

**1.3.3.1** No facility shall be placed in BellSouth's conduit system in violation of FCC regulations.

**1.3.3.2** MCIm's facilities placed in BellSouth's conduit system shall not be designed to use the earth as the sole conductor for any part of MCIm's circuits.

**1.3.3.3** MCIm's facilities carrying more than 50 volts AC (rms) to ground or 135 volts DC to ground shall be enclosed in an effectively grounded sheath or shield.

**1.3.3.4** No coaxial cable of MCIm shall occupy a conduit system containing BellSouth's cable unless such cable of MCIm meets the voltage limitations of Article 820 of the National Electrical Code.

**1.3.3.5** MCIm's coaxial cable may carry continuous DC voltages up to 1800 volts to ground where the conductor current will not exceed one-half amperes and where such cable has two separate grounded metal sheaths or shields and a suitable insulating jacket over the outer sheath or shield. The power supply shall be so designed and maintained that the total current carried over the outer sheath shall not exceed 200 micro amperes under normal conditions. Conditions which would increase the current over this level shall be cleared promptly.

**1.3.3.6** Neither party shall circumvent the other party's corrosion mitigation measures. Each party's new facilities shall be compatible with the other party's facilities so as not to damage any facilities of the other party by corrosion or other chemical reaction.

**1.3.4 Additional Physical Design Specifications.** MCIm's facilities placed in BellSouth's conduit system must meet all of the following physical design specifications:

**1.3.4.1** Cables bound or wrapped with cloth or having any

kind of fibrous coverings or impregnated with an adhesive material shall not be placed in BellSouth's conduit or ducts.

1.3.4.2 The integrity of BellSouth's conduit system and overall safety of BellSouth's personnel and other personnel working in BellSouth's conduit system requires that "dielectric cable" be required when MCIm's cable facility utilizes an alternative duct or route that is shared in the same trench by any current carrying facility of a power utility.

1.3.4.3 New construction splices in MCIm's fiber optic and twisted pair cables shall be located in manholes, pull boxes or handholes.

**1.3.5 Additional Specifications Applicable to Connections.** The following specifications apply to connections of MCIm's conduit to BellSouth's conduit system:

1.3.5.1 MCIm will be permitted to connect its conduit or duct only at the point of a BellSouth manhole. No attachment will be made by entering or breaking into conduit between manholes. All necessary work to install MCIm facilities will be performed by MCIm or its contractor at MCIm's expense. In no event shall MCIm or its contractor "core bore" or make any other modification to BellSouth manhole(s) without the prior written approval of BellSouth, which approval will not be unreasonably delayed or withheld.

1.3.5.2 BellSouth may monitor, at MCIm's expense, the entrance and exit of MCIm's facilities into BellSouth's manholes and the placement of MCIm's facilities in BellSouth's manholes.

1.3.5.3 If MCIm constructs or utilizes a duct connected to BellSouth's manhole, the duct and all connections between that duct and BellSouth's manhole shall be sealed, to the extent practicable, to prevent the entry of gases or liquids into BellSouth's conduit system. If MCIm's duct enters a building, it shall also be sealed where it enters the building and at all other locations necessary to prevent the entry of gases and liquids from the building into BellSouth's conduit system.

**1.3.6 Requirements Relating to Personnel, Equipment, Material, and Construction Procedures Generally.** Duct clearing, rodding or modifications required to grant MCIm access to BellSouth's conduit

systems may be performed by BellSouth at MCIm's expense at charges which represent BellSouth's actual costs. Alternatively (at MCIm's option) such work may be performed by MCIm or a contractor provided that the entity performing the work demonstrates compliance with BellSouth certification requirements, which certification requirements shall be consistent with FCC rules. The parties acknowledge that MCIm, its contractors, and other persons acting on MCIm's behalf will perform work for MCIm (e.g., splicing MCIm's facilities) within BellSouth's conduit system. MCIm represents and warrants that neither MCIm nor any person acting on MCIm's behalf shall permit any person to climb or work on or in any of BellSouth's poles or to enter BellSouth's manholes or work within BellSouth's conduit system unless such person has the training, skill, and experience required to recognize potentially dangerous conditions relating to pole or the conduit systems and to perform the work safely.

**1.3.6.1 MCIm's facilities within BellSouth's conduit system shall be constructed, placed, rearranged, modified, and removed upon receipt of a license specified in 1.5.1. However, no such license will be required for the inspection, maintenance, repair or non-physical modifications of MCIm's facilities.**

**1.3.6.2 "Rodding" or clearing of ducts in BellSouth's conduit system shall be done only when specific authorization for such work has been obtained in advance from BellSouth, which authorization shall not be unreasonably delayed or withheld by BellSouth. The parties agree that such rodding or clearing shall be performed according to existing industry standards and practices. MCIm may perform such work itself or may contract with BellSouth for performance of such work or (at MCIm's option) with a contractor provided that the entity performing the work demonstrates compliance with BellSouth certification requirements which certification requirements shall be consistent with FCC rules.**

**1.3.6.3 Personnel performing work on BellSouth's or MCIm's behalf in BellSouth's conduit system shall not climb on, step on, or otherwise disturb the other party's or any third party's cables, air pipes, equipment, or other facilities located in any manhole or other part of BellSouth's conduit system.**

**1.3.6.4 Personnel performing work on BellSouth's or MCIm's behalf within BellSouth's conduit system (including**

any manhole) shall, upon completing their work, make reasonable efforts to remove all tools, unused materials, wire clippings, cable sheathing and other materials brought by them to the work site.

1.3.6.5 All of MCIm's facilities shall be firmly secured and supported in accordance with Bellcore and industry standards.

1.3.6.6 MCIm's facilities shall be plainly identified with MCIm's name in each manhole with a firmly affixed permanent tag that meets standards set by BellSouth for its own facilities.

1.3.6.7..Left Blank Intentionally..

1.3.6.8 Planks or other types of platforms shall not be installed using cables, pipes or other equipment as a means of support. Platforms shall be supported only by cable racks.

1.3.6.9 Any leak detection liquid or device used by MCIm or personnel performing work on MCIm's facilities within BellSouth's conduit system shall be of a type approved by BellSouth or Bellcore..

1.3.6.10 When MCIm or personnel performing work on MCIm's behalf are working within or in the vicinity of any part of BellSouth's poles or conduit system which is located within, under, over, or adjacent to streets, highways, alleys or other traveled rights-of-way, MCIm and all personnel performing work on MCIm's behalf shall follow procedures which MCIm deems appropriate for the protection of persons and property. MCIm shall be responsible, at all times, for determining and implementing the specific steps required to protect persons and property at the site. MCIm will provide all traffic control and warning devices required to protect pedestrian and vehicular traffic, workers and property from danger. MCIm has sole responsibility for the safety of all personnel performing work on MCIm's behalf, for the safety of bystanders, and for insuring that all operations conform to current OSHA regulations and all other governmental rules, ordinances or statutes. BellSouth reserves the right to suspend MCIm's activities on, in or in the vicinity of BellSouth's poles or conduit system if, in BellSouth's reasonable judgment, any hazardous condition arises due to

the activity (including both acts and omissions) of MCIm or any personnel performing work on MCIm's behalf, which suspension shall cease when the condition has been rectified.

1.3.6.11 Except for protective screens, no temporary cover shall be placed by MCIm or personnel performing work on MCIm's behalf over an open manhole unless it is at least four feet above the surface level of the manhole opening.

1.3.6.12 Smoking or the use of any open flame is prohibited in BellSouth's manholes, in any other portion of BellSouth's conduit system, or within 10 feet of any open manhole entrance; provided that this provision will not prohibit the use of spark producing tools such as electric drills, fusion splicers, etc.

1.3.6.13 Artificial lighting, when required, will be provided by MCIm. Only explosion-proof lighting fixtures shall be used.

1.3.6.14 Neither MCIm nor personnel performing work on MCIm's behalf shall allow any combustible gas, vapor, liquid, or material to accumulate in BellSouth's conduit system (including any manhole) during work operations performed within or in the vicinity of BellSouth's conduit system.

1.3.6.15 MCIm will abide by any laws, regulations or ordinances regarding the use of spark producing tools, equipment or devices in BellSouth's manholes, in any other portions of BellSouth's conduit system, or within 10 feet of any open manhole opening. This includes, but is not limited to, such tools as electric drills and hammers, meggers, breakdown sets, induction sets, and the like.

**1.3.7 Opening of Manholes.** The following requirements apply to the opening of BellSouth's manholes and the authority of BellSouth personnel present when work on MCIm's behalf is being performed within or in the vicinity of BellSouth's conduit system.

1.3.7.1 BellSouth's manholes shall be opened only as permitted by BellSouth's authorized employees or agents, which permission shall not be unreasonably denied or delayed.

1.3.7.2 MCIm shall notify BellSouth forty-eight (48) hours in advance of any routine work operation requiring entry into any of BellSouth's manholes.

1.3.7.3 MCIm shall be responsible for obtaining any necessary authorization from appropriate authorities to open manholes for conduit work operations therein.

1.3.7.4 BellSouth's authorized employee or agent shall not direct or control the conduct of MCIm's work at the work site. The presence of BellSouth's authorized employee or agent at the work site shall not relieve MCIm or personnel performing work on MCIm's behalf of their responsibility to conduct all work operations within BellSouth's conduit system in a safe and workmanlike manner.

1.3.7.5 Although BellSouth's authorized employee or agent shall not direct or control the conduct of MCIm's work at the work site, BellSouth's employee or agent shall have the authority to suspend MCIm's work operations within BellSouth's conduit system if, in the reasonable discretion of such BellSouth employee or agent, it appears that any hazardous conditions arise or any unsafe practices are being followed by MCIm or personnel performing work on MCIm's behalf.

**1.3.8 OSHA Compliance: Notice to BellSouth of Unsafe Conditions.** MCIm agrees that:

1.3.8.1 Its facilities shall be constructed, placed, maintained, repaired, and removed in accordance with the Occupational Safety and Health Act (OSHA) and all rules and regulations promulgated thereunder;

1.3.8.2 All persons acting on MCIm's behalf, including but not limited to MCIm's employees, agents, contractors, and subcontractors shall, when working on or within BellSouth's poles or conduit system, comply with OSHA and all rules and regulations thereunder;

1.3.8.3 MCIm shall establish appropriate procedures and controls to assure compliance with all requirements of this Attachment; and

1.3.8.4 MCIm (and any person acting on MCIm's behalf) may report unsafe conditions on, in or in the vicinity of BellSouth's poles or conduit system to BellSouth.

**1.3.9 Compliance with Environmental Laws and Regulations.** MCIm acknowledges that, from time to time, environmental

contaminants may enter BellSouth's conduit system and accumulate in manholes or other conduit facilities and that certain conduits (transit) are constructed with asbestos-containing materials. If BellSouth has knowledge of the presence of such contaminants in a conduit for which MCIm has applied for or holds a license, BellSouth will promptly notify MCIm of such fact. Notwithstanding any of BellSouth's notification requirements in this Agreement, MCIm acknowledges that some of BellSouth's conduit is fabricated from asbestos-containing materials. Such conduit is generally marked with a designation of "C Fiber Cement Conduit," "Transit," or "Johns-Manville." Unless sampling or manufacturer's certification proves otherwise, MCIm will presume that all conduit not fabricated of plastic, tile, or wood is asbestos-containing and will handle it pursuant to all applicable regulations relating to worker safety and protection of the environment. BellSouth makes no representations to MCIm or personnel performing work on MCIm's behalf that BellSouth's conduit system or any specific portions thereof will be free from environmental contaminants at any particular time. The acknowledgments and representations set forth in the two preceding sentences are not intended to relieve BellSouth of any liability which it would otherwise have under applicable law for the presence of environmental contaminants in its conduit facilities. MCIm agrees to comply with the following provisions relating to compliance with environmental laws and regulations:

**1.3.9.1 MCIm's facilities shall be constructed, placed, maintained, repaired, and removed in accordance with all applicable federal, state, and local environmental statutes, ordinances, rules, regulations, and other laws, including but not limited to the Resource Conservation and Recovery Act (42 U.S.C. §§ 9601 et seq.), the Toxic Substance Control Act (15 U.S.C. §§ 2601-2629), the Clean Water Act (33 U.S.C. §§ 1251 et seq.), and the Safe Drinking Water Act (42 U.S.C. §§ 300f-300j).**

**1.3.9.2 All persons acting on MCIm's behalf, including but not limited to MCIm's employees, agents, contractors, and subcontractors, shall, when working on, within or in the vicinity of BellSouth's poles or conduit system, comply with all applicable federal, state, and local environmental laws, including but not limited to all environmental statutes, ordinances, rules, and regulations.**

**1.3.9.3 MCIm shall establish appropriate procedures and controls to assure compliance with all requirements of this**

section.

**1.3.9.4 Left Blank Intentionally.**

**1.3.10 Compliance with Other Governmental Requirements.**

MCIm agrees that its facilities attached to BellSouth's facilities shall be constructed, placed, maintained, and removed in accordance with the ordinances, rules, and regulations of any governing body having jurisdiction of the subject matter. MCIm shall comply with all applicable statutes, ordinances, rules, regulations and other laws requiring the marking and lighting of aerial wires, cables and other structures to ensure that such wires, cables and structures are not a hazard to aeronautical navigation. MCIm shall establish appropriate procedures and controls to assure such compliance.

**1.3.11 Differences in Standards or Specifications.** To the extent that there may be differences in any applicable standards or specifications referred to in this Section 1.3, the most stringent standard or specification shall apply.

**1.3.12 MCIm Solely Responsible for the Condition of Its Facilities.**

MCIm shall be responsible at all times for the condition of its facilities and its compliance with the requirements, specifications, rules, regulations, ordinances, and laws specified in 1.3.1-1.3.11 above. In this regard, BellSouth shall have no duty to MCIm to inspect or monitor the condition of MCIm's facilities (including but not limited to splices and other facilities connections) located within BellSouth's conduit and ducts or any attachment of MCIm's facilities to BellSouth's poles, anchors, anchor/guy strands or other pole facilities. BellSouth may, however, conduct such inspections and audits of its poles and conduit system as BellSouth determines reasonable or necessary. Such inspection and audits shall be conducted at BellSouth's expense with the exception of (1) follow-up inspection to confirm remedial action after an observed MCIm violation of the requirements of this Agreement; and (2) inspection of MCIm facilities in compliance with a specific mandate of appropriate governmental authority for which inspections the cost shall be borne by MCIm. Either party may audit the other party's compliance with the terms of this Section 1.3.12.

**1.3.13 Efficient Use of Conduit.** BellSouth will install inner-ducts to increase duct space in existing conduit as facilities permit. The full compliment of inner-ducts will be installed which can be accommodated under sound engineering principles. The number



of inner-ducts which can reasonably be installed will be determined by BellSouth, pursuant to such engineering principles.

#### 1.4 ADDITIONAL LEGAL REQUIREMENTS

##### 1.4.1 Left Blank Intentionally

1.4.1.1 Licenses granted under this Attachment authorize MCIm to place facilities in, or attach facilities to, poles, conduits and ducts owned or controlled by BellSouth but do not affect the rights of landowners to control terms and conditions of access to their property.

1.4.1.2 MCIm agrees that neither MCIm nor any persons acting on MCIm's behalf, including but not limited to MCIm's employees, agents, contractors, and subcontractors, shall engage in any conduct which damages public or private property in the vicinity of BellSouth's poles or conduit system, interferes in any way with the use or enjoyment of public or private property except as expressly permitted by the owner of such property, or creates a hazard or nuisance on such property (including, but not limited to, a hazard or nuisance resulting from any abandonment or failure to remove MCIm's facilities or any construction debris from the property, failure to erect warning signs or barricades as may be necessary to give notice to others of unsafe conditions on the premises while work performed on MCIm's behalf is in progress, or failure to restore the property to a safe condition after such work has been completed).

1.4.2 Required Permits, Certificates and Licenses. MCIm shall be responsible for obtaining any additional building permits or certificates from governmental authorities necessary to construct, operate, maintain and remove its facilities on public or private property.

1.4.2.1 MCIm shall not attach or place its facilities to or in BellSouth's poles, conduit or duct located on any property for which it or BellSouth has not first obtained all required authorizations.

1.4.2.2 BellSouth shall have the right to request evidence that all appropriate authorizations have been obtained. However, such request shall not delay BellSouth's prelicense survey work.

1.4.3 Lawful Purposes. All facilities placed by MCIm in BellSouth's

conduit and ducts or on BellSouth's poles, anchors or anchor/guy strands must serve a lawful purpose and the uses made of MCIm's facilities must comply with all applicable federal, state, and local laws and with all federal, state, and local regulatory rules, regulations, and requirements. In this regard, MCIm shall not utilize any facilities occupying or attached to BellSouth's conduits, ducts or poles for the purpose of providing any services which it is not authorized by law to provide or for the purpose of enabling any other person or entity to provide any such services.

## 1.5 FACILITIES AND LICENSES

**1.5.1 Licenses Required.** Before placing any facilities in BellSouth's conduits or ducts or attaching any facilities to BellSouth's poles, anchors or anchor/guy strands, MCIm must first apply for and receive a written license from BellSouth. BellSouth shall not unreasonably deny or delay issuance of any license and, in any event, BellSouth shall issue such license within twenty (20) business days from (i) submission of the license application if make-ready work is not required, or (ii) completion of make-ready work, if make-ready work is needed.

### **1.5.2 Provision of Records and Information to MCIm.**

**1.5.2.1** In order to obtain information regarding facilities, MCIm shall make a written request to BellSouth, identifying with reasonable specificity the geographic area for which facilities are required, the types and quantities of the required facilities and the required in-service date. In response to such request, BellSouth shall provide MCIm with information regarding the types, quantity and location (which may be provided by provision of route maps and availability of BellSouth poles, conduit and right-of-way located within the geographic area specified by MCIm. Provision of information under the terms of this section shall include the right of MCIm employees or agents to inspect and copy engineering records or drawings which pertain to those facilities within the geographic area identified in MCIm's request. Such inspection and copying shall be done at a time and place mutually agreed upon by the parties.

**1.5.2.2** ..Left Blank Intentionally.

### **1.5.3 MAKE-READY WORK**

**1.5.3.1** If performed by BellSouth, make-ready work to

accommodate MCIm's facilities shall be included in the normal work load schedule of BellSouth with construction responsibilities in the geographic areas where the relevant poles or conduit systems are located and shall not be entitled to priority, advancement, or preference over other work to be performed by BellSouth in the ordinary course of BellSouth's business.

1.5.3.2 If MCIm desires make-ready work to be performed on an expedited basis and BellSouth agrees to perform the work on such a basis, BellSouth shall recalculate the estimated make-ready charges. If MCIm accepts BellSouth's offer, MCIm shall pay such additional charges.

1.5.3.3 All charges for make-ready work performed by BellSouth are payable in advance, with the amount of any such advance payment to be due within sixty (60) days after receipt of an invoice from BellSouth.

1.5.3.4 In lieu of obtaining performance of make-ready work by BellSouth, MCIm at its option may perform the make-ready work itself or arrange for the performance of such work by a contractor. The party performing the work must be certified by BellSouth to work on or in its facilities. Certification shall be granted based upon reasonable and customary criteria employed by BellSouth in the selection of its own contract labor in accordance with FCC rules. Notwithstanding any other provisions of this Attachment, MCIm may not employ a contractor to accomplish make-ready work if BellSouth is likewise precluded from contractor selection under the terms of an applicable joint use agreement.

1.5.3.5 BellSouth will issue a license to MCIm at the time all make-ready work necessary to MCIm's attachment or occupancy has been completed.

1.5.4 Application Form and Fees. To apply for a license under this Attachment, MCIm shall submit to BellSouth two signed copies of an Application and Conduit Occupancy License form or an Application and Pole Attachment License form. BellSouth will process license applications in the order in which they are received; provided, however, that when MCIm has multiple applications on file with BellSouth, MCIm may designate its desired priority of completion of prelicense surveys and make-ready work with respect to all such applications.

1.5.4.1 Each application for a license under this Attachment shall specify the proposed route of MCIm's facilities and identify the conduits and ducts or poles and pole facilities along the proposed route in which MCIm desires to place or attach its facilities, and describe the physical size, weight and jacket material of the cable which MCIm desires to place in each conduit or duct or the number and type of cables, apparatus enclosures and other facilities which MCIm desires to attach to each pole.

1.5.4.2 Each application for a license under this Attachment shall be accompanied by a proposed (or estimated) construction schedule containing the information specified below in 1.8.1 of this Attachment, and an indication of whether MCIm will, at its option, perform its own make-ready work.

1.5.4.3 The parties agree to the establishment of a joint task force, consisting of representatives of MCIm and BellSouth, which will develop all procedures necessary to effectuate the provisions of this Section 1.5. Matters to be addressed by the joint task force include, without limitation, the development of time frames for BellSouth's provision of record information and availability determinations and for the processing of license applications; the establishment of guidelines to address the number of MCIm applications which may be processed simultaneously by BellSouth; and any other matters necessary to effectuate the provisions of this Attachment. The parties agree to negotiate in good faith to achieve agreement on all matters presented to the joint task force and to reduce said agreement to writing within sixty (60) calendar days from the Effective Date of this Agreement.

1.5.5 Assignment of Conduit, Duct and Pole Space. Within twenty (20) business days of receipt of MCIm's application. BellSouth shall approve the assignment of space for pole attachment and conduit occupancy. If no make ready work is required, such assignment shall include a granting of the license. If make ready is to be performed by BellSouth, such assignment shall remain in effect until make ready costs are presented to MCIm and approval by MCIm pursuant to the timeframes herein stated. If MCIm approves BellSouth's make ready costs, MCIm shall have twelve (12) months from the date of assignment or sixty (60) days after

completion of make ready by BellSouth, whichever time is later, to install its facilities. If MCIm rejects BellSouth's costs for make ready, but then elects to perform the make ready itself or through a contractor or if MCIm elects from the time of application to perform the make ready itself or through a contractor, MCIm shall install its facilities within twelve (12) months from the date of assignment. In the event MCIm does not install its facilities within the time frames set out in this paragraph, the assignment shall be void and such space shall become available.

**1.5.6 Multiple Cables, Multiple Services, Lashing or Placing Additional Cables, and Replacement of Facilities.** MCIm may include multiple cables in a single license application and multiple services (e.g., CATV and non-CATV services) may be provided by MCIm in the same cable sheath. MCIm's lashing additional cable to existing facilities of MCIm and placing additional cables in conduits or ducts already occupied by MCIm's facilities shall be permitted, and no additional fees will be applied; provided, however, that if MCIm desires to lash additional cable to existing facilities or place additional cables in conduits or ducts which are already occupied, or to replace existing facilities with new facilities substantially different from those described in licenses in effect, MCIm must apply for and acquire a new license specifically describing the physical size, weight and jacket material of the cable to be placed in BellSouth's conduits and ducts or the physical size, weight, and jacket type of cables and the size and weight of apparatus enclosures and other facilities to be attached to BellSouth's poles.

**1.5.7 Single Point of Contact.** Each party hereby designates the employees named below as their single point of contact for any and all purposes of this Attachment, including, but not limited to, processing licenses and applications and providing records and information. Each party may at any time designate a new point of contact by giving written notice of such change.

[Title of Single Point of Contact]  
[Address, phone and fax]

**1.5.8** Anything to the contrary herein notwithstanding, notification of an emergency condition which poses an immediate threat to life or property or substantially impairs provisioning of BellSouth's service shall be reported to BellSouth by contacting:

[BellSouth name]

[Address, phone and fax]

## 1.6 PROCESSING OF APPLICATIONS (INCLUDING PRELICENSE SURVEYS AND FIELD INSPECTIONS)

1.6.1 MCIm's Priorities. When MCIm has multiple applications on file with BellSouth, MCIm shall designate its desired priority of completion of prelicense surveys and make-ready work with respect to all such applications.

1.6.2 Prelicense Survey. After MCIm has submitted its written application for a license, a prelicense survey (including a field inspection) will be performed by either party, in the company of a representative of the other party as mutually agreed, to determine whether BellSouth's poles, anchors and anchor/guy strands, or conduit system, in their present condition, can accommodate MCIm's facilities, without substantially interfering with the ability of BellSouth or any other authorized person or entity to use or access the pole, anchor or anchor/guy strand or any portion of BellSouth's conduit system or facilities attached to BellSouth's pole or placed within or connected to BellSouth's conduit system. If MCIm gives its prior written consent in writing, the determination of duct availability may include the "rodding" of ducts at MCIm's expense.

1.6.2.1 The purpose of the prelicense survey is to determine whether space is available for MCIm's proposed attachments or whether MCIm's proposed attachments to BellSouth's poles or occupancy of BellSouth's conduit and ducts will substantially interfere with use of BellSouth's facilities by BellSouth and others with facilities occupying, connected or attached to BellSouth's pole or conduit system; and to provide information to MCIm for its determination of whether the pole, anchor, anchor/guy strand, conduit, duct, or right-of-way is suitable for its use.

1.6.2.2 Based on information provided by BellSouth, MCIm shall determine whether BellSouth's pole, anchor, anchor/guy strand, conduit and duct facilities are suitable to meet MCIm's needs.

1.6.2.3 BellSouth may not unreasonably refuse to continue to process an application based on BellSouth's determination that MCIm's proposed use of BellSouth's facilities will not be in compliance with applicable requirements, specifications, rules, regulations, ordinances,

and laws. MCIm shall be responsible for making its own, independent determination that its use of such facilities will be in compliance with such requirements, specifications, rules, regulations, ordinances and laws. MCIm acknowledges that BellSouth is not explicitly or implicitly warranting to MCIm that MCIm's proposed use of BellSouth's facilities will be in compliance with applicable requirements, specifications, rules, regulations, ordinances, and laws.

1.6.3 Left Blank Intentionally.

1.6.4 Administrative Processing. The administrative processing portion of the prelicense survey (which includes without limitation processing the application, preparing make-ready work orders, notifying joint users and other persons and entities of work requirements and schedules, coordinating the relocation/rearrangement of BellSouth and/or other licensed facilities) will be performed by BellSouth at MCIm's expense. Anything to the contrary herein notwithstanding, BellSouth shall bear no responsibility for the relocation, rearrangement or removal of facilities used for the transmission or distribution of electric power.

1.7 ISSUANCE OF LICENSES

1.7.1 Obligation to issue Licenses. BellSouth shall issue a license to MCIm pursuant to this section 1.7. BellSouth and MCIm acknowledge that each application for a license shall be evaluated on an individual basis. Nothing contained in this Attachment shall be construed as abridging any independent pole attachment rights or conduit or duct access rights which MCIm may have under the provisions of any applicable federal or state laws or regulations governing access to BellSouth's poles, conduits and ducts, to the extent the same are not inconsistent with the Telecommunications Act of 1996. Each license issued hereunder shall be for an indefinite term, subject to MCIm's compliance with the provisions applicable to such license and further subject to MCIm's right to terminate such license at any time for any reason upon at least thirty (30) days' prior written notice.

1.7.2 Issuance of Licenses When No Make-Ready Work is Required. If BellSouth determines that no make-ready work is required, BellSouth shall approve applications for pole attachment

and conduit occupancy licenses and issue such licenses within twenty (20) business days of receipt of MCIm's application.

**1.7.3 Multiple Applications.** MCIm acknowledges that multiple parties including BellSouth may seek to place their facilities in BellSouth's conduit and ducts at or about the same time, that the make-ready work required to prepare BellSouth's facilities to accommodate multiple applicants may differ from the make-ready work required to accommodate a single applicant, that issues relating to the proper apportionment of costs arise in multi-applicant situations that do not arise in single-applicant situations, and that cooperation and negotiations between all applicants and BellSouth may be necessary to resolve disputes involving multiple applications for permission to place facilities in/on the same pole, conduit, duct, or right-of-way.

**1.7.3.1** All applications will be processed on a first-come, first served basis.

**1.7.4 Agreement to Pay for All Make-Ready Work Completed.** MCIm's submission of written authorization for make-ready work shall also constitute MCIm's agreement to pay additional cost-based charges, if any, for completed make-ready work.

**1.7.5 Payments to Others for Expenses Incurred in Transferring or Arranging Their Facilities.** MCIm shall make arrangements with the owners of other facilities located in or connected to BellSouth's conduit system or attached to BellSouth's poles, anchors or anchor/guy strands regarding reimbursement for any expenses incurred by them in transferring or rearranging their facilities to accommodate the placement or attachment of MCIm's facilities in or to BellSouth's structures.

**1.7.6 Make-Ready Work on an Expedited Basis.**

**1.7.6.1.1** If MCIm is willing to authorize BellSouth to perform make-ready work on an expedited basis, and if BellSouth agrees to perform the work on such a basis, BellSouth shall recalculate the estimated make-ready charges. If MCIm accepts BellSouth's offer, upon completion of the make-ready work MCIm shall pay such additional charges, if any.

**1.7.7 License.** When MCIm's application for a pole attachment or conduit occupancy license is approved, and all required



make-ready work completed, BellSouth will execute and return a signed authorization to MCIm, as appropriate, authorizing MCIm to attach or place the specified facilities on BellSouth's poles or in BellSouth's conduit or ducts.

1.7.7.1 Each license issued under this Attachment shall authorize MCIm to attach to BellSouth's poles or place or maintain in BellSouth's conduit or ducts only those facilities specifically described in the license, and no others.

1.7.7.2 Except as expressly stated to the contrary in individual licenses issued hereunder, each license issued pursuant to this Attachment shall incorporate all terms and conditions of this Attachment whether or not such terms or conditions are expressly incorporated by reference on the face of the license itself.

## 1.8 CONSTRUCTION OF MCIm's FACILITIES

1.8.1 Construction Schedule. MCIm shall submit with MCIm's license application a proposed or estimated construction schedule. Promptly after the issuance of a license permitting MCIm to attach facilities to BellSouth's poles or place facilities in BellSouth's conduit or ducts, MCIm shall provide BellSouth with an updated construction schedule and shall thereafter keep BellSouth informed of significant anticipated changes in the construction schedule. Construction schedules required by this Attachment shall include, at a minimum, the following information:

1.8.1.1 The name, title, business address, and business telephone number of the manager responsible for construction of the facilities;

1.8.1.2 The names of each contractor and subcontractor which will be involved in the construction activities;

1.8.1.3 The estimated dates when construction will begin and end; and

1.8.1.4 The approximate dates when MCIm or persons acting on MCIm's behalf will be performing construction work in connection with the placement of MCIm's facilities in BellSouth's conduit or ducts.

**1.8.2 Additional Pre-construction Procedures for Facilities Placed in Conduit System.** The following procedures shall apply before MCIm places facilities in BellSouth's conduit system:

**1.8.2.1** MCIm shall give written notice of the type of facilities which are to be placed; and

**1.8.2.2** BellSouth shall designate the manner in which MCIm's facilities will enter and exit BellSouth's conduit system, and the specific location and manner of installation of any associated equipment which is permitted by BellSouth to occupy the conduit system. BellSouth shall provide to MCIm space in manholes for racking and storage of up to fifty (50) feet of cable, provided space is available.

**1.8.3 BellSouth Not Responsible for Constructing or Placing Facilities.** BellSouth shall have no obligation to construct any facilities for MCIm or to attach MCIm's facilities to, or place MCIm's facilities in, BellSouth's poles or conduit system, except as may be necessary to facilitate the interconnection of unbundled network elements or except to the extent expressly provided in this Attachment, any license issued hereunder, or by the Telecommunications Act of 1996 or any other applicable law.

**1.8.4 MCIm Responsible for Constructing, Attaching and Placing Facilities.** Except where otherwise mutually agreed by MCIm and BellSouth, MCIm shall be responsible for constructing its own facilities and attaching those facilities to, or placing them in BellSouth's poles, conduit or ducts at MCIm's sole cost and expense. MCIm shall be solely responsible for paying all persons and entities who provide materials, labor, access to real or personal property, or other goods or services in connection with the construction and placement of MCIm's facilities and for directing the activities of all persons acting on MCIm's behalf while they are physically present on BellSouth's pole, in any part of BellSouth's conduit system or in the vicinity of BellSouth's poles or conduit system.

**1.8.5 Compliance with Applicable Standards, Health and Safety Requirements, and Other Legal Requirements.** MCIm shall construct its facilities in accordance with the provisions of this Attachment and all licenses issued hereunder.

**1.8.5.1** MCIm shall construct, attach and place its facilities in compliance with all Requirements and Specifications set forth above in Section 1.3 of this Attachment.

## **MCIm - BellSouth Florida Interconnection Agreement**

**1.8.5.2** MCIm shall satisfy all Legal Requirements set forth above in Section 1.4 of this Attachment .

**1.8.5.3** MCIm shall not permit any person acting on MCIm's behalf to perform any work on BellSouth's poles or within BellSouth's conduit system without first verifying, to the extent practicable, on each date when such work is to be performed, that the condition of the pole or conduit system is suitable for the work to be performed. If MCIm or any person working on MCIm's behalf determines that the condition of the pole or conduit system is not suitable for the work to be performed, MCIm shall notify BellSouth of the condition of the pole or conduit system in question and shall not proceed with construction activities until MCIm is satisfied that the work can be safely performed.

**1.8.6** Construction Notices. If requested to do so, MCIm shall provide BellSouth with information to reasonably assure BellSouth that construction has been performed in accordance with all applicable standards and requirements.

**1.8.7** Manhole and Conduit Break-Outs. MCIm shall be permitted to add conduit ports to BellSouth manholes when existing conduits do not provide the pathway connectivity needed by MCIm; provided the structural integrity of the manhole is maintained, and sound engineering judgment is employed.

### **1.9 USE AND ROUTINE MAINTENANCE OF MCIm's FACILITIES**

**1.9.1** Use of MCIm's Facilities. Each license granted under this Attachment authorizes MCIm to have access to MCIm's facilities on or in BellSouth's poles, conduits and ducts as needed for the purpose of serving MCIm's customers, including, but not limited to, powering electronics, monitoring facilities, or transporting signaling.

**1.9.2** Routine Maintenance of MCIm's Facilities. Each license granted under this Attachment authorizes MCIm to engage in routine maintenance of MCIm's facilities located on or in BellSouth's poles, conduits, ducts and ROW pursuant to such license. MCIm shall give reasonable notice to the affected public authority or private landowner as appropriate before commencing the construction or installation of its attachments or making any material alterations thereto. MCIm shall give reasonable notice to BellSouth before performing any work, whether or not of a routine nature, in BellSouth's conduit system.

**1.9.3 MCIIm Responsible for Maintenance of MCIIm's Facilities.**

MCIIm shall maintain its facilities in accordance with the provisions of this Attachment (including but not limited to all Requirements set forth above in Section 1.3 of this Attachment ) and all licenses issued hereunder. MCIIm shall be solely responsible for paying all persons and entities who provide materials, labor, access to real or personal property, or other goods or services in connection with the maintenance of MCIIm's facilities and for directing the activities of all persons acting on MCIIm's behalf while they are physically present on BellSouth's poles, within BellSouth's conduit system or in the immediate vicinity of such poles or conduit system.

**1.9.4 BellSouth Not Responsible for Maintaining MCIIm's Facilities.**

BellSouth shall have no obligation to maintain any facilities which MCIIm has attached or connected to, or placed in, BellSouth's poles, conduits, ducts or any portion of BellSouth's conduit system, except to the extent expressly provided by the provisions of this Attachment or any license issued hereunder, or by the Telecommunications Act of 1996 or other applicable laws, rules or regulations.

**1.9.5 Information Concerning the Maintenance of MCIIm's Facilities.** Promptly after the issuance of a license permitting MCIIm to attach facilities to, or place facilities in BellSouth's poles, conduits or ducts, MCIIm shall provide BellSouth with the name, title, business address, and business telephone number of the manager responsible for routine maintenance of MCIIm's facilities, and shall thereafter notify BellSouth of changes to such information. The manager responsible for routine maintenance of MCIIm's facilities shall, on BellSouth's request, identify any contractor, subcontractor, or other person performing maintenance activities on MCIIm's behalf at a specified site and shall, on BellSouth's request, provide such additional documentation relating to the maintenance of MCIIm's facilities as reasonably necessary to demonstrate that MCIIm and all persons acting on MCIIm's behalf are complying with the requirements of this Attachment and licenses issued hereunder.

**1.9.6 Identification of Personnel Authorized to Have Access to MCIIm's Facilities.** All personnel authorized to have access to MCIIm's facilities shall, while working on BellSouth's poles, in its conduit system or ducts or in the vicinity of such poles, ducts or conduit systems, carry with them suitable identification and shall, upon the request of any BellSouth employee, produce such identification.

**1.10 MODIFICATION AND REPLACEMENT OF MCIm's FACILITIES**

**1.10.1 Notification of Planned Modification or Replacement of Facilities.** MCIm shall, when practicable, notify BellSouth in writing at least 60 days before adding to, relocating, replacing or otherwise modifying its facilities attached to a BellSouth pole, anchor or anchor/guy strand or located in any BellSouth conduit or duct. The notice shall contain sufficient information to enable BellSouth to determine whether the proposed addition, relocation, replacement, or modification is permitted under MCIm's present license or requires a new or amended license.

**1.10.2 New or Amended License Required.** A new or amended license will be required if the proposed addition, relocation, replacement, or modification:

**1.10.2.1** Requires that MCIm use additional space on BellSouth's poles or in its conduits or ducts (including but not limited to any additional ducts, inner ducts, or substantial space in any handhole or manhole) on either a temporary or permanent basis; or

**1.10.2.2** Results in the size or location of MCIm's facilities on BellSouth's poles or in its conduit or ducts being appreciably different from those described and authorized in MCIm's present license (e.g. different duct or size increase causing a need to re-calculate storm loadings, guying, or pole class).

**1.11 REARRANGEMENT OF FACILITIES AT THE REQUEST OF ANOTHER**

**1.11.1 Make-Ready Work at the Request of MCIm.** If, prior to the issuance of a license, MCIm determines that any pole, anchor, anchor/guy strand, conduit or duct is inadequate to accommodate MCIm's proposed pole attachment or conduit occupancy or that it will be necessary or desirable for BellSouth or any other person or entity to rearrange existing facilities or structures to accommodate MCIm, MCIm shall promptly advise BellSouth of the make-ready work it believes necessary to enable the accommodation of MCIm's facilities.

**1.11.1.1** BellSouth shall determine, in the exercise of sound engineering judgment, whether or what such make-ready work is necessary or possible. In determining whether

make-ready work is necessary BellSouth shall endeavor to minimize its costs. If it is determined that such make-ready work is required, within twenty (20) business days of such determination BellSouth shall provide MCIm with the estimated costs for make-ready work and a Make-Ready Due Date.

1.11.1.2 MCIm shall be solely responsible for negotiating with persons or entities other than BellSouth for the rearrangement of such persons' or entities' facilities or structures and, except where such rearrangement is for the benefit of BellSouth and/or other licensees as well as MCIm, shall be solely responsible for paying all charges attributable to the rearrangement of such facilities; provided, however, that if facilities rearrangements require new licenses from BellSouth, BellSouth shall issue such licenses in conjunction with the issuance of the applied-for license to MCIm.

1.11.2 Rearrangement of MCIm's Facilities at BellSouth's Request. MCIm acknowledges that, from time to time, it may be necessary or desirable for BellSouth to change out poles, relocate, reconstruct, or modify portions of its conduit system or rearrange facilities contained therein or connected thereto and that such changes may be necessitated by BellSouth's business needs or authorized application of another entity seeking access to BellSouth's poles or conduit systems. MCIm agrees that MCIm will, upon BellSouth's request, and at BellSouth's expense, but at no cost to MCIm, participate with BellSouth (and other licensees) in the relocation, reconstruction, or modification of BellSouth's conduit system or facilities rearrangement. MCIm acknowledges that, from time to time, it may be necessary or desirable for BellSouth to change out poles, relocate, reconstruct, or modify portions of its conduit system or rearrange facilities contained therein or connected thereto as a result of an order by a municipality or other governmental authority. MCIm shall, upon BellSouth's request, participate with BellSouth (and other licensees) in the relocation, reconstruction, or modification of BellSouth's conduit system or facilities rearrangement and pay its proportionate share of any costs of such relocation, reconstruction, or modification that are not reimbursed by such municipality or governmental authority.

1.11.2.1 MCIm shall make all rearrangements of its facilities within such period of time as is jointly deemed reasonable by the parties based on the amount of rearrangements necessary and a desire to minimize chances for service

interruption or facility-based service denial to an MCIIm customer.

1.11.2.2 If MCIIm fails to make the required rearrangements within the time prescribed in 1.11.2.1 preceding or within such extended periods of time as may be granted by BellSouth in writing, BellSouth may perform such rearrangements with written notice to MCIIm, and MCIIm shall reimburse BellSouth for actual costs and expenses incurred by BellSouth in connection with the rearrangement of MCIIm's facilities; provided, however, that nothing contained in this Attachment or any license issued hereunder shall be construed as requiring MCIIm to bear any expenses which, under the Telecommunications Act of 1996 or other applicable federal or state laws or regulations, are to be allocated to persons or entities other than MCIIm; and provided further, however, that MCIIm shall have no responsibility for rearrangement costs and expenses relating to rearrangements performed for the purpose of meeting BellSouth's business needs or the business needs of any other licensee/joint user. .

## 1.12 EMERGENCY REPAIRS AND POLE REPLACEMENTS

1.12.1 Within sixty (60) days after the Effective Date of this Agreement, BellSouth and MCIIm shall mutually agree on a non-discriminatory priority method to access BellSouth poles, conduit and ROW in emergency situations.

1.12.2 MCIIm Responsible for Emergency Repairs to its Own Facilities. In general, MCIIm shall be responsible for making emergency repairs to its own facilities and for formulating appropriate plans and practices which will enable it to make such emergency repairs. BellSouth shall be under no obligation to perform any repair or service restoration work of any kind with respect to MCIIm's facilities.

## 1.13 INSPECTION BY BellSouth OF MCIIm's FACILITIES

1.13.1 BellSouth's Right to Make Periodic or Spot Inspections. BellSouth shall have the right to make periodic or spot inspections at any time of any part of MCIIm's facilities attached to BellSouth's poles, anchors or anchor/guy strands or occupying any BellSouth conduit or duct for the limited purpose of determining whether MCIIm's facilities are in compliance with the terms of this

## MCIm - BellSouth Florida Interconnection Agreement

Attachment and licenses hereunder; provided that such inspections must be non-invasive (e.g., no splice cases may be opened).

1.13.1.1 BellSouth will give MCIm advance written notice of such inspections, and MCIm shall have the right to have a representative attend such inspections, except in those instances where safety considerations justify the need for such inspection without the delay of waiting until written notice has been forwarded to MCIm.

1.13.1.2 Such inspections shall be conducted at BellSouth's expense, provided, however, that MCIm shall bear the cost of inspections as delineated in Section 1.3.12.

1.13.2 No Duty to MCIm. Neither the act of inspection by BellSouth of MCIm's facilities nor any failure to inspect such facilities shall operate to impose on BellSouth any liability of any kind whatsoever or to relieve MCIm of any responsibility, obligations or liability under this Attachment or otherwise existing.

### 1.14 NOTICE OF NONCOMPLIANCE

1.14.1 Notice of Noncompliance. If, at any time, BellSouth determines that MCIm's facilities or any part thereof have not been placed or maintained or are not being used in accordance with the requirements of this Attachment, BellSouth may send written notice to MCIm specifying the alleged noncompliance. MCIm agrees to acknowledge receipt of the notice as soon as practicable. If MCIm does not dispute BellSouth's assertion that such facilities are not in compliance, MCIm agrees to provide BellSouth with a schedule for bringing such facilities into compliance, to bring the facilities into compliance within a reasonable time, and to notify BellSouth in writing when the facilities have been brought into compliance.

1.14.2 Disputes over Alleged Noncompliance. If MCIm disputes BellSouth's assertion that MCIm's facilities are not in compliance, MCIm shall notify BellSouth in writing of the basis for MCIm's assertion that its facilities are in compliance.

1.14.3 Failure to Bring Facilities into Compliance. If MCIm has not brought the facilities into compliance within a reasonable time or provided BellSouth with proof sufficient to persuade BellSouth that BellSouth erred in asserting that the facilities were not in



compliance, and if BellSouth determines in good faith that the alleged noncompliance causes or is likely to cause material damage to BellSouth's facilities or those of others users, BellSouth may, at its option and MCIm's expense, take such non-service affecting steps as may be required to bring MCIm's facilities into compliance, including but not limited to correcting any conditions which do not meet the specifications of Section 1.3 of this Attachment .

**1.14.4 Correction of Conditions by BellSouth.** If BellSouth elects to bring MCIm's facilities into compliance as provided by Section 1.14.3 of this Attachment, the provisions of this Attachment shall apply.

**1.14.4.1** BellSouth will, whenever practicable, notify MCIm in writing before performing such work. The written notice shall describe the nature of the work to be performed and BellSouth's schedule for performing the work.

**1.14.4.2** If MCIm's facilities have become detached or partially detached from supporting racks or wall supports located within a BellSouth manhole, BellSouth may, at MCIm's expense, reattach them but shall not be obligated to do so. If BellSouth does not reattach MCIm's facilities, BellSouth shall endeavor to arrange with MCIm for the reattachment of any facilities affected.

BellSouth shall, as soon as practicable after performing the work, advise MCIm in writing of the work performed or action taken. Upon receiving such notice, MCIm shall inspect the facilities and take such steps as MCIm may deem necessary to insure that the facilities meet MCIm's performance requirements.

**1.14.5 MCIm to Bear Expenses.** MCIm shall bear all expenses arising out of or in connection with any work performed to bring MCIm's facilities into compliance with this Attachment; provided, however that nothing contained in this Attachment or any license issued hereunder shall be construed as requiring MCIm to bear any expenses which, under applicable federal or state laws or regulations, must be borne by persons or entities other than MCIm.

## **1.15 UNAUTHORIZED OCCUPANCY OR UTILIZATION OF BellSouth's FACILITIES**

**1.15.1 Licensing or Removal of Unauthorized Attachments.** If any of MCIIm's attachments shall be found attached to pole(s) or occupying conduit systems for which no license is outstanding, BellSouth, without prejudice to its other rights or remedies under this Agreement, including termination of licenses, may impose a charge and require MCIIm to submit in writing, within thirty (30) days after receipt of written notification from BellSouth of the unauthorized attachment or conduit occupancy, a pole attachment or conduit occupancy license application. If such application is not received by BellSouth within the specified time period, MCIIm may be required at BellSouth's option to remove its unauthorized attachment or occupancy within sixty (60) days of the final date for submitting the required application, or BellSouth may at the end of such sixty (60) day period, at BellSouth's option remove MCIIm's facilities without liability, and the expense of such removal shall be borne by MCIIm. Charges for any such unauthorized occupancy shall be equal to the applicable license fees and charges which would have been payable from and after the date such facilities were first placed on BellSouth's poles or in BellSouth's conduit system, if MCIIm provides reasonable documentation of such placement. If MCIIm is unable to provide such reasonable documentation the matter may be submitted to the Dispute Resolution Procedures, described in Part A of this Agreement. If BellSouth prevails in such Dispute Resolution, then MCIIm will pay two years worth of the applicable charges.

**1.15.1** Nothing contained in the Agreement or any license issued hereunder shall be construed as requiring MCIIm to bear any expenses which, under applicable federal or state laws or regulations, must be borne by persons or entities other than MCIIm.

**1.15.2 Prompt Payment of Applicable Fees and Charges.** Fees and charges for unauthorized pole attachments and conduit system occupancies, as specified herein and as modified from time to time, shall be due and payable immediately whether or not MCIIm is permitted to continue the pole attachment or conduit occupancy.

**1.15.3 No Implied Waiver or Ratification of Unauthorized Use.** No act or failure to act by BellSouth with regard to said unlicensed use shall be deemed as a ratification of the unlicensed use; and if any license should be subsequently issued, said license shall not operate retroactively or constitute a waiver by BellSouth of any of its rights or privileges under this Attachment or otherwise; provided, however, that MCIIm shall be subject to all liabilities, obligations and responsibilities of this Agreement in regard to said

unauthorized use from its inception.

## 1.16 REMOVAL OF MCIm's FACILITIES

1.16.1 Pole Attachments. MCIm, at its expense, will remove its attachments from any of BellSouth's poles within thirty (30) days after termination of the license covering such attachments. If MCIm fails to remove its attachments within such thirty (30) day period, BellSouth shall have the right to remove such attachments at MCIm's expense and without any liability on the part of BellSouth for damage or injury to MCIm's attachments unless caused by the negligence or intentional misconduct of BellSouth.

1.16.2 Conduit Occupancy. MCIm, at its expense, will remove its communications facilities from a conduit system within sixty (60) days after:

1.16.2.1 Termination of the license covering such conduit occupancy; or

1.16.2.2 The date MCIm replaces its existing facilities in one duct with substitute facilities in another duct.

1.16.3 If MCIm fails to remove its facilities within the specified period, BellSouth shall have the right to remove such facilities at MCIm's expense and without any liability on the part of BellSouth for damage or injury to such facilities unless caused by the negligence or intentional misconduct of BellSouth.

1.16.4 Continuing Responsibility for Fees and Charges. MCIm shall remain liable for and pay to BellSouth all fees and charges pursuant to provisions of this Agreement until all of MCIm's facilities are physically removed from BellSouth's poles or conduit system.

## 1.17 FEES, CHARGES, AND BILLING

1.17.1 License Charges. License charges commence on the first day of the calendar month following the date a license is issued. Such charges cease as of the final day of the calendar month preceding the month in which the attachment or occupancy is physically removed or the utilization is discontinued. A one-month minimum charge is applicable to all licenses.

1.17.2 Notice of Rate and Computation of Charges. On or about November 1 of each year, BellSouth will notify MCIm by certified

mail, return receipt requested, of the rental rate and pole transfer rate to be applied in the subsequent calendar year. The letter of notification shall be incorporated in, and governed by, the terms and conditions of this Agreement. Attachment and occupancy rates shall be applied to the number of pole(s) and duct feet of conduit for which licenses have been issued before December 1 of each calendar year. Charges for attachment(s) and occupancy which commenced during the preceding twelve (12) month period will be prorated accordingly.

#### **1.18 ADVANCE PAYMENT AND IMPUTATION**

**1.18.1 Attachment and Occupancy Fees.** Fees for pole attachment and conduit occupancy shall be based on the facilities for which licenses have been issued as of the date of billing by BellSouth, shall be computed as set forth in Attachment 1 of this Agreement and shall be payable annually.

**1.18.1.1** Charges associated with newly licensed attachments or occupancies and other attachments or occupancies of less than the entire annual billing period shall be prorated.

**1.18.1.2** Charges shall be prorated retroactively in the event of the removal of MCIm's facilities.

**1.18.2** The amount of any advance payment required under this Section 3.20 shall be due within sixty (60) days after receipt of an invoice from BellSouth.

**1.18.3 Imputation.** BellSouth shall impute to its costs of providing telecommunications services (and charge any affiliate, subsidiary, or associate company engaged in the provision of such services) an equal amount to the charges set forth in this Attachment for all of the conduits, ducts, and poles it occupies and uses.

#### **1.19 ASSURANCE OF PAYMENT**

**1.19.1** In the event MCIm fails to demonstrate credit worthiness, MCIm may be required to furnish a bond, letter of credit or other evidence of financial security having a minimum face amount of \$10,000.00 per state or \$50,000.00 per region. Such bond, letter of credit or other security shall be in a form satisfactory to BellSouth and may be increased from time to time as reasonably

**MCIm - BellSouth Florida Interconnection Agreement**

required by BellSouth to guarantee the performance of all obligations of MCIm hereunder. The amount of the bond, letter of credit or other security shall not operate as a limitation upon the obligations of MCIm hereunder.

***Section 2. Dark Fiber – This section is Left Blank Intentionally pursuant to Orders of the Florida Public Service Commission***

**Exhibit I**

**ADMINISTRATIVE FORMS AND NOTICES**

This Exhibit II lists the types of administrative forms to be utilized in connection with this Attachment .

**LIST OF ADMINISTRATIVE FORMS**

Authorization for Make-Ready Work  
Application and Conduit Occupancy License  
Conduit System Diagram  
Cable to Occupy Conduit  
Equipment Housings to be Placed in manholes  
Notification of Surrender or Modification of Conduit  
Occupancy License by Licenses  
Notifications of Unauthorized Attachments by Applicant  
Application and Pole Attachment License  
Pole, Anchor and Guy Strand Details  
Application and Unused Transmission Media License  
Application Survey Data  
Notification of Surrender or Modification of Pole  
Attachment License by Licenses

**TABLE OF CONTENTS**

**Attachment VII  
NUMBER PORTABILITY**

Section 1.	BellSouth Provision of Number Portability	VII - 1
Section 2.	Interim Number Portability (INP)	VII - 1
Section 3.	Number Portability (NP)	VII - 3
Section 4.	Requirement for INP and NP	VII - 8

## ATTACHMENT VII

### NUMBER PORTABILITY

#### ***Section 1 BellSouth Provision of Number Portability***

BellSouth and MCIm shall provide number portability in accordance with the requirements of the Act and applicable FCC rules and Regulations in effect. Interim Number Portability (INP) will be provided by BellSouth to MCIm, and MCIm to BellSouth, immediately upon the Effective Date of this Agreement. INP will be provided with minimum impairment of functionality, quality, reliability and convenience to subscribers of both companies' services. The parties will provide Permanent Number Portability (PNP) as soon as it is technically feasible, in conformance with FCC Orders, Rules and Regulations in effect and the Act.

#### ***Section 2. Interim Number Portability (INP)***

INP shall be provided by Remote Call Forwarding ("RCF"), Route Indexing, Route Indexing - Portability Hub, Local Exchange Routing Guide (LERG) reassignment, and FLEX-DID, and MCI shall select which of these methods shall be used for each application. MCIm shall specify on a per telephone number basis which method of INP is to be employed and BellSouth shall provide such method to the extent Technically Feasible.

**2.1 Remote Call Forwarding:** Remote Call Forwarding (RCF) is an INP method to provide subscribers with service-provider portability by redirecting calls within the telephone network. When RCF is used to provide interim number portability, calls to the ported number will first route to the BellSouth switch to which the ported number was previously assigned. The BellSouth switch will then forward the call to a number associated with the MCIm designated switch to which the number is ported. MCIm may order any additional paths to handle multiple simultaneous calls to the same ported telephone number as specified by MCIm.

**2.2 FLEX-DID** is an INP method that makes use of direct inward dialing trunks. Each FLEX-DID trunk group used for INP is dedicated to carrying FLEX-DID INP traffic between the BellSouth end office and the MCIm switch. Traffic on these trunks cannot overflow to other trunks, so the number of trunks shall be conservatively engineered by BellSouth.



BellSouth shall provide FLEX-DID on an individual number basis as specified by MCIm. Also, inter-switch signaling is usually limited to multi-frequency (MF). This precludes passing CLID to the MCIm switch. However, BellSouth intends to use SS7.

**2.3 Route Indexing:** Route Indexing may take two forms: Route Index-Portability Hub (RI-PH) or Directory Number-Route Index (DN-RI).

**2.3.1 Where Technically Feasible,** RI-PH will route a dialed call to the BellSouth switch associated with the NXX of the dialed number. The BellSouth switch shall then insert a prefix onto the dialed number which identifies how the call is to be routed to MCIm. The prefixed dialed number is transmitted to the BellSouth tandem switch to which MCIm is connected.

The prefix is removed by the operation of the tandem switch and the dialed number is routed to MCIm's switch so the routing of the call can be completed by MCIm.

**2.3.2 DN-RI is a form of RI-PH that requires direct trunking between the BellSouth switch to which the ported number was originally assigned and the MCIm switch to which the number has been ported. The BellSouth switch shall send the originally dialed number to the MCIm switch without a prefix.**

**2.3.3 BellSouth shall provide RI-PH or DN-RI on an individual telephone number basis, as designated by MCIm. Where Technically Feasible, MCIm may designate both methods so that calls to ported numbers are first directed to the MCIm switch over direct trunks but may overflow to tandem trunks if all trunks in the direct group are occupied.**

**2.3.4 For both RI-PH and DN-RI the trunks used may, at MCIm's option, and where Technically Feasible, be the same as those used for exchange of other local traffic and toll traffic with BellSouth. At MCIm's option, the trunks shall employ SS7 or in band signaling.**

**2.4 LERG Reassignment:** Portability for an entire NXX shall be provided by utilizing reassignment of the block to MCIm through industry recognized guidelines and the Local Exchange Routing Guide (LERG). Updates to translations in the BellSouth switching office from which the telephone number is ported will be made by the BellSouth prior to the date on which LERG changes become effective, in order to redirect calls to the MCIm switch via route indexing or the INP method specified by MCIm.

**2.5 Other Currently Available Number Portability Provisions:**

**2.5.1 BellSouth shall exchange with MCIm, SS7 TCAP messages as required for the implementation of Custom Local Area Signaling Services (CLASS) or other features available in the BellSouth network. CLID shall be passed by BellSouth to MCIm.**

**2.5.2 Upon notification from MCIm that it will be initiating INP, BellSouth shall disclose to MCIm any technical or capacity limitations that would prevent the use of the requested INP method in a particular switching office. BellSouth and MCIm shall cooperate in the process of porting numbers to minimize subscriber out-of-service time, including updating switch translations where necessary within timeframes on parity with establishment of new services for BellSouth's customers, but in any event BellSouth shall use its best efforts not to exceed thirty (30) minutes after notification that physical cut-over has been completed (or initiated), as MCIm may designate.**

**2.5.3 For INP, MCIm shall have the right to use the existing BellSouth 911 infrastructure for all 911 capabilities. When an INP method is used for MCIm subscribers, both the ported numbers and shadow numbers shall be stored in 911/ALI databases. MCIm shall have the right to verify the accuracy of the information in the PSAP databases.**

**2.5.4 When any INP method is used to port a subscriber, the donor provider must maintain the Line Information Database (LIDB) record for that number to reflect appropriate conditions as reported to it by the porting service provider. The donor must outclear call records to MCIm for billing and collection from the subscriber. MCIm shall receive revenue for LIDB look-ups.**

**2.5.5 BellSouth should send a CARE transaction 2231 to notify IXC that access is now provided by a new CLEC for that number.**

***Section 3. Number Portability (NP)***

**BellSouth and MCIm agree to implement NP as follows, to the extent the parties mutually agree the following is consistent with FCC orders in effect in FCC Docket 95-116 and the directions from the appropriate industry forum:**

**3.1.1 The requirements for NP shall include the following:**

**MCIm - BellSouth Florida Interconnection Agreement**

**3.1.2** Subscribers must be able to change local service providers and retain the same telephone number(s) consistent with FCC Rules and Regulations.

**3.1.3** The NP network architecture shall not subject alternate local exchange carriers to any degradation of service compared to BellSouth in any relevant measure, including transmission quality, switching and transport costs, increased call set-up time and post-dial delay, and MCIm shall not be required to rely on the BellSouth network for calls completing to its ported subscribers.

**3.1.4** When an office is equipped with NP, all NXXs in the office shall be defined as portable and translations will be changed in all service provider switches to open those NXXs for database queries. If a switch serves multiple rate centers, then at a minimum, all of the NXXs for a rate center in that switch shall be made portable when any one of them is turned up.

**3.1.5** When an NXX is defined as portable, it shall also be defined as portable in all LRN-capable offices which have direct trunks to the given switch.

**3.1.6** Upon introduction of LRN in a market area, the tandems (local and access) shall be among the first converted, with no unreasonable delay. All portable NXXs shall be recognized in these tandems as portable, with queries launched from these switches.

**3.1.7** Left blank intentionally

**3.1.8** When a subscriber ports to another service provider and has previously secured a reservation of line numbers from the donor provider for possible activation at "some future point, these reserved but inactive numbers shall "port" along with the active numbers being ported by the subscriber in order to ensure that the end user subscriber will be permitted to expand its service using the same number range it could use if it remained with the donor provider.

**3.1.9** During the process of porting a subscriber, the donor service provider shall implement the 10-Digit trigger feature. When the donor provider receives the porting request, the 10-Digit trigger shall be applied to the Subscriber's line at least 24 hours prior to the order due date in order to overcome donor network time delays in the disconnection of the subscriber. Alternatively, when an

activation notice is sent to an NPAC to trigger a broadcast to service provider databases, the donor switch shall have its translations changed to disconnect the subscriber's line within fifteen (15) minutes of the donor network Local SMS's having received the broadcast.

### 3.2 Joint Cooperation

Both MCI and BellSouth shall:

Support all emergency and operator services.

Use scarce numbering resources efficiently and administer such resources in a competitively neutral manner.

Jointly cooperate with each other to ensure that both carriers shall be able to rate and bill all types of calls.

Jointly cooperate with each other to apply NP consistently on a nationwide basis, and in accordance with all Federal Communication Commission directives.

### 3.3 Location Routing Number (LRN)

BellSouth and MCI shall work to implement the LRN-NP solution.

3.3.1 A ten-digit code, consistent with the North American Numbering Plan, called the location routing number (LRN) shall be used as a network address for each switch that terminates subscriber lines, i.e. an end office. LRN shall support existing six-digit routing and may be implemented without changes to existing switch routing algorithms. In existing end offices, the LRN shall be selected from one of its existing NPA-NXXs. New end offices shall be assigned LRNs through normal administrative processes.

3.3.2 LRN employs an "N-1" Query Strategy for interLATA or intraLATA toll calls, by which the originating carrier will pass the call to the appropriate toll carrier who will perform a query to an external routing database and route the call to the appropriate terminating local carrier either directly or through an access tandem office. For a local call to a ported number, the originating carrier is the "N-1" carrier. It will perform an external database query and pass the call to the appropriate terminating carrier. The "N-1" methodology will be used to extend portability on a phased, region-by-region basis and it does not place BellSouth or other carriers

needlessly in the call path.

3.3.3 BellSouth shall furnish MCIm with the first six digits of the originating LRN when it supplies MCIm with the Jurisdiction Information Parameter for the Initial Address Message.

3.3.4 BellSouth agrees to begin the introduction of LRN to end user subscribers who may begin changing local service providers and retaining their existing telephone number based on the time line set out by the FCC in its Telephone Number Portability Order (CC Docket No. 95-116), or as per a State order if such time for introduction of LRN set by the State is earlier than would result under the FCC Order.

3.3.5 The generic requirements for LRN are specified in the following publications: Generic Switching and Signaling Requirements for Number Portability, Issue 1.03, September 4, 1996 [Editor - Lucent Technologies, Inc.]; Generic Requirements for SCP Application and GTT Function for Number Portability, Issue 0.31, Final Draft, March 24, 1996 [Editor - Ameritech Inc.]; and Generic Operator Services Switching Requirements for Number Portability, Issue 1.00, Final Draft, April 12, 1996 [Editor - Nortel].

#### 3.4 Additional NP Requirements

3.4.1 For local calls to a portable NXX native to another end-office, BellSouth shall query an external database as soon as the call reaches the first NP-capable switch in the call path. An LRN-capable originating switch shall query on a local call to a portable NXX as soon as it determines that it (the originating switch) does not serve the dialed number.

3.4.2 BellSouth shall be the default carrier for database queries where a participating carrier is unable to perform its own query due to abnormal conditions.

3.4.3 BellSouth will provide MCIm INP and NP for subscribers moving to a different location, or staying at the same location, within the same rate center area.

#### 3.5 SMS Administration

BellSouth will work cooperatively with other local service providers to establish the NP Service Management System (SMS). The SMS shall be administered by a neutral third party, to provide for the efficient porting of

numbers between carriers. There must be one exclusive NPAC per portability State or region, and BellSouth shall provide all information uploads and downloads regarding ported numbers to/from, respectively, the exclusive NPAC. BellSouth and MCIm shall cooperate to facilitate the expeditious deployment of LRN-based NP through the process prescribed by the FCC, including, but not limited to, participation in the selection of a neutral third party and development of SMS, as well as SMS testing for effective procedures, electronic system interfaces, and overall readiness for use consistent with that specified for Provisioning in this Agreement.

### 3.6 Cut-Over Process

BellSouth shall cooperate in the process of porting numbers from one carrier to another so as to limit service outage for the ported subscriber. This shall include, but not be limited to, updating its network element translations within five (5) minutes following notification by the industry SMS, or ported-to local service provider, and deploying such temporary translations as may be required to minimize service outage, e.g., unconditional triggers. Also, MCIm shall have the right to determine who initiates the order for INP in specific cut-over situations.

For a Coordinated Cutover Environment, BellSouth shall verbally coordinate with MCIm the disconnect and switch translation as close to the requested time as possible. The coordination shall be pre-specified by MCIm and agreed to by both parties and in no case shall begin more than 20 minutes after the agreed upon time.

For a Non-Coordinated Cutover Environment, BellSouth shall schedule a mechanized update of disconnect and switch translations at the MCIm requested cutover time (frame due time). Such updates will be available seven (7) days a week, twenty-four (24) hours a day. BellSouth shall provide an Operation contact whom MCIm can reach in the event manual intervention is needed to complete the cutover. In the event of manual intervention, BellSouth shall notify MCIm immediately of the need for manual intervention and shall provide MCIm with a completion schedule and project plan for resolving the issue requiring intervention within thirty (30) minutes from the time the need for manual intervention was identified, and shall resolve such issue as soon as possible.

3.7 With respect to operator services and directory listings associated with NP for MCIm subscribers, BellSouth shall provide the following when NP is in place:

3.7.1 The Provisions in 4.6.1.1~4.6.1.5 below, shall apply when NP is in place.

3.7.2 If Integrated Services Digital Network User Part (ISUP)

signaling is used BellSouth shall provide the Jurisdiction Information Parameter in the SS7 Initial Address Message. (See Generic Switching and Signaling Requirements for Number Portability, Issue 1.03, September 4, 1996 (Editor - Lucent Technologies, Inc.))

3.7.3 BellSouth shall provide a 10-Digit Global Title Translation (GTT) Node for routing queries for TCAP-based operator services (e.g., LIDB).

3.8 BellSouth OSS shall meet all requirements specified in "Generic Operator Services Switching Requirements for Number Portability," Issue 1.00, Final Draft, April 12, 1996.

#### **Section 4. Requirements for INP and NP**

##### **4.1 White and Yellow Page Listings**

LEC shall provide and maintain for MCIm one (1) white page and one (1) yellow page (if applicable) listing for each MCIm subscriber that has ported its number from BellSouth, consistent with that specified for Provisioning in this Agreement. The listing and handling of listed and nonlisted telephone numbers will be at least at parity with that provided by BellSouth to its own subscribers.

##### **4.2 Call Referral Announcements**

BellSouth shall allow MCIm to order call referral announcements, and specify the particular announcement from BellSouth's standard set of call referral announcement options, on a per telephone number basis, for telephone numbers which MCIm has ported from BellSouth to MCIm and for which such ILNP measures have, at MCIm's direction, been terminated.

##### **4.3 Testing**

BellSouth and MCIm shall cooperate in conducting MCIm's testing to ensure interconnectivity between systems. BellSouth shall inform MCIm of any system updates that may affect the MCIm network and BellSouth shall, at MCIm's request, perform tests to validate the operation of the network. Additional testing requirements may apply as specified by this Agreement.

##### **4.4 Engineering and Maintenance**

## **MCIIm - BellSouth Florida Interconnection Agreement**

BellSouth and MCIIm will cooperate to ensure that performance of trunking and signaling capacity is engineered and managed at levels which are at least at parity with that provided by BellSouth to its subscribers and to ensure effective maintenance testing through activities such as routine testing practices, network trouble isolation processes and review of operational elements for translations, routing and network fault isolation.

Additional specific engineering and maintenance requirements shall apply as specified in this Agreement.

### **4.5 Recording and Billing**

BellSouth shall provide MCIIm with accurate billing and Subscriber Account Record Exchange data for MCIIm subscribers whose numbers have been ported.

4.5.1 Calls originated from RCF ported numbers in BellSouth end offices and sent to the MCIIm network must signal the shadow number in the Calling Party Number (CgPN) parameter and ported number in the Charge Number (CN) parameter in the SS7 Initial Address Message.

### **4.6 Operator Services and Directory Listings.**

With respect to operator services and directory listings associated with NP for MCIIm subscribers, BellSouth shall provide the following:

4.6.1 While INP is deployed and prior to conversion to NP:

4.6.1.1 BellSouth shall allow MCIIm to order provisioning of Telephone Line Number (TLN) calling cards and Billed Number Screening (BNS), in its LIDB, for numbers ported to MCIIm, as specified by MCIIm. BellSouth shall continue to allow MCIIm access to its LIDB. Other LIDB provisions are specified in this Agreement.

4.6.1.2 Where BellSouth has control of directory listings for NXX codes containing ported numbers, BellSouth shall maintain entries for ported numbers as specified by MCIIm.



**TABLE OF CONTENTS**

**ATTACHMENT VIII**

**BUSINESS PROCESS REQUIREMENTS**

<b>SECTION 1. GENERAL BUSINESS REQUIREMENTS</b>	<b>1</b>
<b>1.1 Procedures</b>	<b>1</b>
1.1.1 BellSouth Contact with Subscribers	1
1.1.2 Expedite, Escalation, and Disaster Procedures	2
1.1.3 Operational and Technological Changes	3
1.1.4 Subscriber of Record	3
1.1.5 Work Center Interface Procedures	3
<b>1.2 Service Offerings</b>	<b>4</b>
1.2.1 Changes in Retail Service Offerings	4
1.2.2 Telephone Service Priority	5
1.2.3 Caller ID	4
1.2.4 TTY/TDD	4
1.2.5 Blocking Services	5
1.2.6 Training Services	5
1.2.7 Carrier Identification Codes	5
<b>SECTION 2. ORDERING AND PROVISIONING</b>	<b>6</b>
<b>2.1 General Business Requirements</b>	<b>6</b>
2.1.1 Ordering and Provisioning Parity	6
2.1.2 Local Carrier Service Center (LCSC)/Single Point of Contact (SPOC)	7
2.1.3 Street Address Guide (SAG)	7
2.1.4 CLASS and Custom Features	8
2.1.5 Subscriber Payment History	8
2.1.6 Carrier Selection	9
2.1.7 Notification to Long Distance Carrier	9
2.1.8 Number Administration/Number Reservations	10
<b>2.2 Service Order Process Requirements</b>	<b>12</b>
2.2.1 OBF Compliance	12
2.2.2 Service Migrations and New Subscriber Additions	12
2.2.3 Intercept Treatment and Transfer of Service Announcements	13
2.2.4 Desired Due Date (DDD)	13
2.2.5 Subscriber Premises Inspections and Installations	14
2.2.6 Firm Order Confirmation (FOC)	14

2.2.7 Order Rejections	15
2.2.8 Service Order Changes	15
2.2.9 Jeopardy Situations	16
2.2.10 Cooperative Testing	16
2.2.11 Service Suspensions/Restorations	16
2.2.12 Disconnects	17
2.2.13 Order Completion Notification	17
2.2.14 Fulfillment Process	17
2.2.15 Specific Unbundling Requirements	17
<b>2.3 Systems Interfaces and Information Exchanges</b>	<b>19</b>
2.3.1 General Requirements	19
2.3.2 Ordering and Provisioning for Resale Services	20
2.3.3 Ordering and Provisioning for Unbundling	23
<b>2.4 Standards</b>	<b>24</b>
2.4.1 General Requirements	24
<b>2.5 Performance Measurements and Reporting</b>	<b>23</b>
2.5.1 Cycle Time Measurements	23
2.5.2 Quality Measurements	24
2.5.3 Provisioning Performance Standards	24
<b>SECTION 3. CONNECTIVITY BILLING AND RECORDING</b>	<b>30</b>
<b>3.1 Procedures</b>	<b>30</b>
<b>3.2 Information Exchange and Interfaces</b>	<b>34</b>
<b>3.3 Standards</b>	<b>38</b>
<b>3.4 Performance Measurements &amp; Reporting</b>	<b>39</b>
<b>SECTION 4. PROVISION OF SUBSCRIBER USAGE DATA</b>	<b>40</b>
<b>4.1 Procedures</b>	<b>40</b>
4.1.1 General	40
4.1.2 Charges	42
4.1.3 Central Clearinghouse & Settlement	42
4.1.4 Lost Data	43
4.1.5 Testing, Changes and Controls	44
<b>4.2 Information Exchange and Interfaces</b>	<b>47</b>
4.2.1 Core Billing Information	47
4.2.2 Supporting Billing Information	48
4.2.3 Product/Service Specific	50

## MCImetro - BellSouth Florida Interconnection Agreement

4.2.4 Emergency Information	50
4.2.5 Rejected Recorded Usage Data	50
4.2.6 Interfaces	51
4.2.7 Formats & Characteristics	51
4.2.8 Controls	53
<b>4.3 Standards</b>	<b>54</b>
<b>4.4 Performance Measurements</b>	<b>54</b>
<b>4.5 Reporting</b>	<b>58</b>
<b>SECTION 5. MAINTENANCE</b>	<b>56</b>
<b>5.1 General Requirements</b>	<b>58</b>
<b>5.2 Systems Interfaces and Information Exchanges</b>	<b>62</b>
<b>5.3 Procedures</b>	<b>64</b>
<b>5.4 Performance Measurements and Reporting</b>	<b>62</b>
5.4.1 Cycle Time Measurements	63
5.4.2 Quality	63
5.4.3 Reporting	63
<b>SECTION 6. MISCELLANEOUS SERVICES &amp; FUNCTIONS</b>	<b>64</b>
<b>6.1 General Requirements</b>	<b>66</b>
6.1.1 Basic 911 and E911 General Requirements	64
6.1.2 Directory Assistance Service	74
6.1.3 Operator Services	76
6.1.4 Directory Assistance and Listings Service Requests	80
6.1.5 Left Blank Intentionally	
6.1.6 Directory Assistance Data	82
<b>6.2 Systems Interfaces and Exchanges</b>	<b>81</b>
6.2.1 Basic 911 and E911 Information Exchanges and Interfaces	81
6.2.2 Directory Assistance Data Information Exchanges and Interfaces	84

## **Section 1. General Business Requirements**

1.0 BellSouth shall provide real-time and interactive access via electronic interfaces as detailed in this Agreement to perform pre-service ordering, service trouble reporting, service order processing and provisioning, customer usage data transfer and local account maintenance. If any of the processes require additional capabilities, BellSouth shall develop the additional capabilities by January 1, 1997. If BellSouth cannot meet that deadline, BellSouth shall file a report with the Commission that outlines why it cannot meet the deadline, the date by which such system will be implemented, and a description of the system or process which will be used in the interim. BellSouth and MCI shall also establish a joint implementation team to assure the implementation of the real-time and interactive interfaces. These electronic interfaces shall conform to industry standards where such standards exist or are developed.

### **1.1 Procedures**

The parties will support machine-to-machine interface for maintenance, preordering and provisioning with the introduction of an industry standard that is subsequently approved by both parties. The parties further agree to make every effort to implement EBI within 12 months of the introduction, and joint approval, of such applicable industry standard or the activation of EBI for access ordering, whichever is later. MCI further agrees to accept on an interim basis, until such time as EBI is implemented, the interfaces approved by BellSouth.

#### **1.1.1 BellSouth Contact with Subscribers**

1.1.1.1 MCI shall at all times shall be the primary contact and account control for all interactions with its subscribers, except as specified by MCI. MCI subscribers include active MCI subscribers as well as those for whom service orders are pending.

1.1.1.2 BellSouth shall ensure that any BellSouth personnel who may receive subscriber inquiries, or otherwise have opportunity for subscriber contact: (i) provide appropriate referrals and telephone numbers to subscribers who inquire about MCI services or products; (ii) do not in any way disparage or discriminate against MCI, or its products or services; and (iii) do not provide information about BellSouth products or services during that same inquiry or subscriber contact.

1.1.1.3 BellSouth shall not use MCIm's request for subscriber information, order submission, or any other aspect of MCIm's processes or services to aid BellSouth's marketing or sales efforts.

1.1.2 Expedite, Escalation, and Disaster Procedures

1.1.2.1 No later than sixty (60) days after the Effective Date of this Agreement, BellSouth and MCIm shall develop mutually acceptable escalation and expedite procedures which may be invoked at any point in the Service Ordering, Provisioning, Maintenance, and Subscriber Usage Data transfer processes to facilitate rapid and timely resolution of disputes. Such procedures may include, without limitation, intercompany contacts lists for purposes of handling subscriber and other matters which require attention/resolution outside of normal business procedures within sixty (60) days after the Effective Date of this Agreement.

1.1.2.2 BellSouth and MCIm agree to jointly develop and implement a detailed service restoration plan and disaster recovery plan to be in effect by year end 1997. A joint task team will commence development within 30 days of execution of this Agreement for implementation throughout 1997, reaching full deployment by year end 1997.

Such plans shall incorporate BellSouth's Emergency Contingency Plans for Residence and Business Repair centers. The Plans shall conform to the FCC Restoration Guidelines, to the NSEP (National Security Emergency Preparedness) procedures and adhere to the guidelines developed by the TSP (Telecommunications Service Priority) System office with the NCS (National Communication System) Agency.

The Plans shall include at a minimum: (i) provision for immediate access by MCIm via the Electronic Interface to be established pursuant to Section 3, to information indicating the existence, location and source of any emergency network outage affecting MCIm customers; (ii) establishment of a single point of contact responsible for initiating and coordinating the restoration of all Local Services and Network Elements or Combinations; (iii) methods and

procedures to provide MCIIm with real-time access to information relating to the status of restoration efforts and problem resolution during the restoration process; (iv) an inventory and description of mobile restoration equipment by locations; (v) methods and procedures for the dispatch of mobile equipment to the restoration site; (vi) methods and procedures for re-provisioning all Local Services and Network Elements or Combinations after initial restoration; (vii) equal priority, as between MCIIm subscribers and BellSouth subscribers, for restoration efforts, consistent with FCC Service Restoration guidelines, including, without limitation, deployment of repair personnel and access to spare parts and components; and (viii) a mutually agreeable process for escalation of maintenance problems, including a complete up-to-date list of responsible contacts, available twenty-four (24) hours per day, seven (7) days per week.

Said plans shall be modified and updated as necessary. For purposes of this subsection, an emergency network outage is defined as 5,000 or more blocked call attempts in a ten (10) minute period in a single exchange.

### **1.1.3 Operational and Technological Changes**

**1.1.3.1** BellSouth shall use its best efforts to notify MCIIm of any operational or technological (e.g., central office switch, transmission, systems interfaces) changes six (6) months in advance, or at the time the decision is made, whichever is less. If notice is given to MCIIm less than six (6) months in advance, BellSouth will work with MCIIm to develop a mutually agreeable implementation plan, if requested by MCIIm. MCIIm agrees that it shall not submit an unreasonable request.

### **1.1.4 Subscriber of Record**

**1.1.4.1** BellSouth shall recognize MCIIm as the Subscriber of Record for all Network Elements or services for resale ordered by MCIIm and shall send all notices, invoices, and information which pertain to such ordered services directly to MCIIm. MCIIm will provide BellSouth with addresses to which BellSouth shall send all such notices, invoices, and information.

### **1.1.5 Work Center Interface Procedures**

1.1.5.1 BellSouth and MCI shall, within 60 days of the Effective Date of this Agreement, develop and implement Work Center (Local Carrier Service Center) Interface Procedures for each function/business process.

## 1.2 Service Offerings

### 1.2.1 Changes in Retail Service Offerings

1.2.1.1 BellSouth shall notify MCI of any proposed changes in the terms and conditions under which BellSouth offers Telecommunications Services to subscribers who are not Telecommunications Service providers or carriers, including, but not limited to, the introduction or discontinuance of any features, functions, services, promotions, or changes in retail rates at least forty-five (45) days prior to the effective date of such change, or concurrent with BellSouth's internal notification process for such change. MCI recognizes that certain revisions may occur between the time BellSouth notifies MCI of a change pursuant to this Section and BellSouth's tariff filing of such change. BellSouth shall notify MCI of such revisions consistent with BellSouth's internal notification process but MCI accepts the consequences of such mid-stream changes as an uncertainty of doing business and therefore will not hold BellSouth responsible for any resulting inconvenience or cost incurred by MCI.

1.2.1.2 BellSouth shall notify MCI of any proposed changes in the terms and conditions under which it offers unbundled Network Elements including, but not limited to, the introduction or discontinuance of any features, functions, services, promotions, or changes in rates at least forty-five (45) days prior to the effective date of such change, or concurrent with BellSouth's internal notification process for such change. MCI recognizes that certain revisions may occur between the time BellSouth notifies MCI of a change pursuant to this Section and BellSouth's tariff filing of such change. BellSouth shall notify MCI of such revisions consistent with BellSouth's internal notification process but MCI accepts the consequences of such mid-stream changes as an uncertainty of doing business and therefore will not hold BellSouth responsible for any resulting inconvenience or cost incurred by MCI.

**1.2.2 Telephone Service Priority**

**1.2.2.1** Upon receipt of a request from MCIm containing the appropriate TSP Authorization Codes assigned by the NSEP-TSP, BellSouth shall identify the account with this code. BellSouth will conform to the framework defined by the NSEP-TSP for restoration on a priority basis of the individual accounts.

**1.2.3 Caller ID**

**1.2.3.1** To the extent BellSouth is authorized to do so, BellSouth shall cooperate with MCIm to provide the BellSouth-approved equipment vendor list associated with Caller ID.

**1.2.4 TTY/TDD**

**1.2.4.1** BellSouth shall cooperate with MCIm to provide services and equipment necessary to serve TTY/TDD subscribers.

**1.2.5 Blocking Services**

Upon request from MCIm, BellSouth shall provide blocking of 700, 900, and 976 services, or other services of similar type as may now exist or be developed in the future, and shall provide Billed Number Screening (BNS), including required LIDB updates, or equivalent service for blocking completion of bill -to- third party and collect calls, on a line, trunk, or individual service basis.

**1.2.6 Training Support**

**1.2.6.1** BellSouth shall develop and deliver training for all BellSouth employees who may communicate with MCIm subscribers. Training will be provided for all ordering, provisioning, maintenance, billing, miscellaneous services, and any other area which is appropriate for the services to be provided by BellSouth pursuant to this Agreement.

**1.2.6.2** BellSouth will initially train MCIm employees on the utilization of electronic interfaces and operational interface procedures with BellSouth support centers for ordering, maintenance and provisioning. BellSouth will provide the



initial training and training due to significant BellSouth system or interface changes to MCI at no charge.

#### 1.2.7 Carrier Identification Codes

BellSouth shall provide to MCI the active Carrier Identification Codes (CIC) for both Dial 1 and 800 services for each of its access tandems on a one time basis in accordance with OBF standards.

### **Section 2. Ordering and Provisioning**

#### **2.1 General Business Requirements**

##### **2.1.1 Ordering and Provisioning Parity**

2.1.1.1 For preordering and provisioning, the parties agree to implement the BellSouth approved and implemented EBI standard for Local Service Requests ("LSR") within 12 months of the implementation of the EBI interface for Access Service Request provisioning. MCI further agrees to accept on an interim basis, until such time as EBI is implemented for LSR, the interfaces approved by BellSouth.

2.1.1.2 During the term of this Agreement, BellSouth shall provide necessary ordering and provisioning business process support as well as those technical and systems interfaces as may be required to enable MCI to provide at least the same level and quality of service for all resale services, functions, features, capabilities and unbundled Network Elements as BellSouth provides itself, its Affiliates or its own subscribers. BellSouth shall provide MCI with the same level of ordering and provisioning support as BellSouth provides itself in accordance with standards and performance measurements that are at least equal to the highest level of standards and/or performance measurements that BellSouth uses and/or which are required by law, regulatory agency, or by BellSouth's own internal procedures, whichever are the most rigorous. These standards shall apply to the quality of the technology, equipment, facilities, processes, and techniques (including, but not limited to, such new architecture, equipment, facilities, and interfaces as BellSouth may deploy) that BellSouth provides to MCI under this Agreement.

For resale purposes, BellSouth shall provide real time electronic interfaces ("EI") for transferring and receiving Service Orders and Provisioning data and materials (e.g., access to Street Address Guide ("SAG") and Telephone Number Assignment database). These interfaces shall be administered through a gateway that will serve as a point of contact for the transmission of such data from MCI to BellSouth, and from BellSouth to MCI. The implementation of such data transfer system shall be negotiated in good faith by the parties and be specified in a written agreement between MCI and BellSouth that will be completed expeditiously after the Effective Date of this Agreement. MCI and BellSouth agree to use best efforts to provide the Electronic Communications gateway described above as soon as practicable, but in no event later than April 1, 1997. In addition, (i) BellSouth agrees to use its best efforts to carry out its responsibilities under this Section, and (ii) MCI agrees to use its best efforts to carry out its responsibilities under this Section interfaces. BellSouth warrants that interim solutions shall provide MCI Customers with the same level of service available to BellSouth customers.

#### **2.1.2 Local Carrier Service Center (LCSC)/Single Point of Contact (SPOC)**

BellSouth shall provide MCI, twenty-four (24) hours a day, seven (7) days a week, with the capability of ordering via an electronic interface, except for scheduled electronic interface downtime and mutually agreed in advance electronic interface downtime. Provisioning shall be available during normal business hours. Downtime shall not be scheduled during normal business hours and shall occur during time where systems experience minimal usage. BellSouth shall provide a Single Point of Contact (SPOC) for all ordering and provisioning contacts and order flow involved in the purchase and provisioning of BellSouth's unbundled Elements, Combinations and Resale. BellSouth's SPOC shall provide to MCI a toll-free nationwide telephone number (operational from 8:30 a.m. to 5:00 p.m., Monday through Friday, within each respective continental US time zone) which will be answered by capable staff trained to answer questions and resolve problems in connection with the ordering and provisioning of Elements or Combinations and resale services.

#### **2.1.3 Street Address Guide (SAG)**

2.1.3.1 Within thirty (30) days after the Effective Date of this Agreement, BellSouth shall provide to MCI the SAG data, or its equivalent, in electronic form. All changes to the SAG shall be made available to MCI on the same day as the change to the data is made.

**2.1.4 CLASS and Custom Features**

2.1.4.1 For purchase of unbundled network elements, MCI may order the entire set of CLASS and Custom features and functions, or, where Technically Feasible, a subset of any one or any combination of such features. For resale purposes, BellSouth shall provide MCI with a list of features and functions available on an end office by end office basis.

**2.1.5 Subscriber Payment History**

2.1.5.1 To the extent each party has such information, MCI and BellSouth agree to make available to each other such of the following subscriber information as the subscriber authorizes BellSouth or MCI to release:

2.1.5.1.1 Applicant's name;

2.1.5.1.2 Applicant's address;

2.1.5.1.3 Applicant's previous phone number, if any;

2.1.5.1.4 Amount, if any, of unpaid balance in applicant's name;

2.1.5.1.5 Whether applicant is delinquent on payments;

2.1.5.1.6 Length of service with prior local or intraLATA toll provider;

2.1.5.1.7 Whether applicant had local or intraLATA toll service terminated or suspended within the last six months with an explanation of the reason therefor; and,

2.1.5.1.8 Whether applicant was required by prior local or intraLATA toll provider to pay a deposit or make an advance payment, including the amount of each.

2.1.5.2 BellSouth shall not refuse service to MCIm for any potential MCIm subscriber on the basis of that subscriber's past payment history with BellSouth. MCIm shall establish the credit scoring criteria for applicants for MCIm services.

2.1.5.3 BellSouth shall provide to MCIm a real-time, electronic interface to BellSouth subscriber information systems which will allow MCIm to obtain the customer payment history information as detailed above. The parties shall mutually agree upon restrictions that will appropriately safeguard subscribers' privacy.

2.1.5.4 Until such time as the Parties reach agreement on the restrictions described in 2.1.5.3, BellSouth shall provide MCIm with requested customer payment history information, as detailed above, based upon MCIm's blanket representation that MCIm will obtain the subscriber's authorization to obtain such data in advance of any request.

## 2.1.6 Carrier Selection

2.1.6.1 For services for resale or unbundled Network Elements, BellSouth shall provide to MCIm, no later than January 1, 1997, the capability to order local service, intraLATA (where available), interLATA, and international toll services by entering the MCIm subscriber's choice of carrier on a single order. BellSouth shall provide MCIm with the capability to order separate interLATA and intraLATA (where available) carriers on a line or trunk basis.

2.1.6.2 Where intraLATA toll carrier selection is not implemented, BellSouth agrees to provide intraLATA toll services for resale to MCIm. In all other cases, BellSouth will route toll calls to the appropriate carrier as designated by MCIm.

2.1.6.3 BellSouth may, when authorized in writing by MCIm, process PIC changes directly from MCIm subscribers. Inquiries from MCIm subscribers regarding the subscribers' PIC shall be referred to contact numbers provided by MCIm

to BellSouth. MCI shall provide any updates to the contact number list in writing to BellSouth.

#### **2.1.7 Notification to Long Distance Carrier**

**2.1.7.1** BellSouth agrees to notify MCI using OBF-approved CARE transactions, whenever an MCI subscriber who is provided local service through services for resale or unbundled Network Elements changes MCI PIC status.

**2.1.7.2** BellSouth shall support and implement new Transaction Code Status Indicators (TCSIs) defined by OBF in support of local resale to enable MCI to provide seamless subscriber service.

**2.1.7.2.1** BellSouth shall implement TCSIs used in conjunction with the new Local Service Provider (LSP) Identification Code, where applicable, for handling Account Maintenance, Subscriber Service, and Trouble Administration issues. These TCSIs include 4001/02/05, 4201-4205, 4301, 2033, 2233, 3147, 3148, 3149, and others as OBF may define.

**2.1.7.2.2** In addition, BellSouth shall implement TCSIs used in conjunction with the new Ported Telephone Number field to link "shadow" and ported telephone numbers in support of Interim Number Portability. These TCSIs may include 2231, 3150, 3151, and others as OBF may define.

**2.1.7.3** Where available, BellSouth shall provide to MCI the Local Service Provider ID (LSP) on purchased lists of MCI PIC'd and non-PIC'd subscribers.

**2.1.7.4** Where available, BellSouth shall provide the Ported Telephone Number (PTN) on purchased CARE lists of MCI PIC'd and non-MCI PIC'd subscribers.

**2.1.7.5** Upon written notice from MCI, BellSouth shall process IXC PIC changes for MCI subscribers.

#### **2.1.8 Number Administration/Number Reservations**

**2.1.8.1** Until Number Administration functions are assumed by a neutral third party in accordance with FCC Rules and

Regulations, BellSouth shall assign NXXs to MCI on a non-discriminatory basis in accordance with national guidelines. BellSouth shall provide the same range of number choices allowing the assignment of numbers while the subscriber is on the phone to MCI, including choice of exchange number, as BellSouth provides its own subscribers. Reservation and aging of numbers shall remain BellSouth's responsibility.

2.1.8.2 Where MCI has not obtained its own NXX, BellSouth shall reserve up to 100 telephone numbers, per MCI request, per NPA-NXX (where available), for large business subscribers in the same manner as for BellSouth's own large business subscribers. BellSouth shall provide additional numbers at MCI's request as subscriber demand requires. Telephone numbers reserved in this manner may be released for other than MCI use only in the same manner that BellSouth would release numbers reserved for its own subscribers. .

2.1.8.3 Where MCI has obtained its own NXX, but has purchased BellSouth services for resale or Network Elements, BellSouth agrees to install the MCI NXX in BellSouth's switch according to the local calling area defined by BellSouth and perform appropriate number administration functions. Where MCI provides its own switching and obtains its own NXX code, BellSouth agrees to install the routing in its switches according to the local calling area defined by MCI.

2.1.8.4 BellSouth shall accept MCI orders with assigned vanity numbers and blocks of numbers assigned for use with complex services including, but not limited to, DID, MULTISERV, and Hunting arrangements. Vanity numbers and numbers for use with complex services, DID and Hunting arrangements will be assigned by the LCSC on a case-by-case basis to meet the needs for specific service order activity.

2.1.8.5 Until the Electronic Interface exists for simple services number reservations, BellSouth shall use its best efforts to provide confirmation of a number reservation within twenty-four (24) hours of receiving a completed MCI's request. For reservations associated with complex services see 2.1.8.4.

## 2.2 Service Order Process Requirements

### 2.2.1 OBF Compliance

2.2.1.1 In accordance with OBF standards, BellSouth and MCI shall follow the OBF-developed ordering and provisioning process standards. These processes include pre-order service inquiry, pre-order service inquiry response, firm order, acknowledgment/ rejection, firm order confirmation, delay notification, and completion notification. BellSouth agrees to work cooperatively to implement future OBF-developed processes related to ordering and provisioning.

### 2.2.2 Service Migrations and New Subscriber Additions

2.2.2.1 For resale services, BellSouth shall not require a disconnect order from a subscriber, another local service provider, or any other entity, to process an MCI order to establish MCI Local Service and/or migrate a subscriber to MCI local service.

2.2.2.2 BellSouth shall not intentionally or unnecessarily disconnect any subscriber service or existing features at any time during the migration of a Resale subscriber to MCI service, unless disconnection is required by an MCI order changing the service type.

2.2.2.3 For services MCI will provide through unbundled Network Elements, BellSouth shall, upon receipt of a BellSouth Blanket Agency Agreement Letter for Local Service Provider provided in the Ordering Guidelines, recognize MCI as an agent for the subscriber in requesting the migration of services provided by another BellSouth or another CLEC. In addition, BellSouth shall not disconnect any BellSouth services provided to the BellSouth subscriber until MCI notifies BellSouth that MCI's unbundled elements are installed and operational, except where existing BellSouth facilities are being reused.

2.2.2.4 Unless otherwise directed by MCI, when MCI orders resale services or Network Elements, where applicable, all trunk or telephone numbers currently associated with existing services shall be retained without

loss of feature capability and without loss of associated ancillary services, except those excluded from resale, partial migration of lines or services affected by the MCIm order which require common blocks of equipment or facilities (e.g. MULTISERV, Hunting, DID), and BellSouth Handicap Exemptions shall be retained. BellSouth shall not intentionally or unnecessarily interrupt feature capability including, but not limited to, Directory Assistance and 911/E911 capability.

**2.2.2.5** For subscriber conversions requiring coordinated cut-over activities, on a per order basis, BellSouth and MCIm will agree on a scheduled conversion time.

**2.2.2.5.1** BellSouth will coordinate activities of all BellSouth work groups involved.

**2.2.2.5.2** BellSouth will notify MCIm when conversion is complete.

**2.2.2.5.3** BellSouth will use its best efforts to minimize subscriber interruptions during conversions.

### **2.2.3 Intercept Treatment and Transfer of Service Announcements**

**2.2.3.1** BellSouth shall provide unbranded intercept treatment and transfer of service announcements to MCIm's subscribers on the same interval and basis as BellSouth provides to its own subscribers for resale and when BellSouth is providing the unbundled switch for MCIm. When MCIm supplies its own unbundled switch, MCIm will determine the service announcement interval.

### **2.2.4 Desired Due Date (DDD)**

**2.2.4.1** MCIm shall specify on each order the Desired Due Date (DDD). BellSouth shall not complete the order prior to DDD unless early turn-up is needed for testing purposes. BellSouth will provide services on the DDD, or on the earliest available installation date thereafter. BellSouth will notify MCIm if the DDD cannot be met.

**2.2.4.2** If the DDD falls after the standard order completion interval provided by BellSouth, then BellSouth, where



facilities are available, shall complete the order on the Desired Due Date.

2.2.4.3 BellSouth shall supply MCIIm with due date intervals to be used by MCIIm personnel to determine service installation dates.

2.2.4.4 Subsequent to an initial order submission, MCIIm may require a new/revised due date that is earlier than the original due date requested. BellSouth will make best effort to meet MCIIm's requested due date, and applicable expedite charges set forth in Attachment I will apply.

2.2.4.5 Any special or preferred scheduling options available, internally or externally to BellSouth, for ordering and provisioning services shall also be available to MCIIm.

## 2.2.5 Subscriber Premises Inspections and Installations -

2.2.5.1 MCIIm shall perform or contract for all needs assessments, including equipment and installation requirements, at the subscriber premises on the subscriber's side of the demarcation point.

2.2.5.2 BellSouth shall provide MCIIm with the ability to schedule subscriber premises installations.

2.2.5.3 In accordance with BellSouth's procedures and on parity with provision of such services to BellSouth's customers, BellSouth shall provide extended demarcation beyond the NID, at MCIIm's request, using intrabuilding riser and lateral beyond the NID.

## 2.2.6 Firm Order Confirmation (FOC)

2.2.6.1 BellSouth shall provide to MCIIm, via an electronic interface, a Firm Order Confirmation (FOC) for each MCIIm order provided electronically. The FOC shall contain on a per line and/or trunk basis, where applicable, an enumeration of MCIIm's ordered unbundled Network Elements (and the specific BellSouth naming convention applied to that element or combination), features, functions, resale services, options, physical interconnection, quantity, and BellSouth Committed Due Date for order completion.

2.2.6.2 For a revised FOC, BellSouth shall provide order detail on a per line or per trunk level as well as the order detail from the prior FOC. BellSouth shall submit, where applicable, to MCI a complete revised list of features, functions and services ordered.

2.2.6.3 BellSouth shall provide to MCI the date that service is initiated.

## 2.2.7 Order Rejections

2.2.7.1 BellSouth shall review MCI local service requests and notify MCI of all known reasons for which the order was rejected. BellSouth shall not reject any orders due to an unavailable Desired Due Date. In that instance, BellSouth will process the order assigning the best available due date. The assigned due date will be returned to MCI as the FOC.

2.2.7.2 Left blank intentionally

2.2.7.3 Left blank intentionally

## 2.2.8 Service Order Changes

2.2.8.1 If an installation requires deviation for the Service Order in any manner, or if a MCI customer requests a service change at the time of installation, BellSouth will call MCI in advance of performing the installation for authorization. BellSouth will provide MCI at that time an estimate of additional labor hours and/or materials required for that installation. After installation is completed, BellSouth will immediately inform MCI of actual labor hours and materials used.

2.2.8.1.1 If work performed in connection with a service order is partially completed, notification which identifies the work that was done and work remaining to complete will be provided at the same level BellSouth provides to itself.

2.2.8.2 Where BellSouth provides installation and the MCI Customer requests a service change at the time of installation. BellSouth shall immediately notify MCI at the telephone number on the service order of that request. The

BellSouth technician should notify MCI in the presence of the MCI Customer so that MCI can negotiate authority to install the requested service directly with that customer and the technician and revise appropriate ordering documents as necessary.

#### 2.2.9 Jeopardy Situations

2.2.9.1 BellSouth shall provide to MCI notification of any jeopardy situations prior to the Committed Due Date, missed appointments and any other delay or problem in completing work specified on MCI's service order as detailed on the FOC.

#### 2.2.10 Cooperative Testing

##### 2.2.10.1 Network Testing

2.2.10.1.1 BellSouth shall perform all pre-service testing prior to the completion of the order, including testing on local service facilities and switch translations, including, but not limited to, verification of features, functions, and services ordered by MCI.

2.2.10.1.2 Within 24-hrs of MCI's request for scheduled cooperative testing, BellSouth shall perform said testing with MCI (including trouble shooting to isolate any problems) to test Network Elements purchased by MCI in order to identify any problems.

##### 2.2.10.2 Systems and Process Testing

2.2.10.2.1 LEC shall cooperate with MCI upon request to test all operational interfaces and processes and thereby ensure that they are in place and functioning properly and efficiently.

#### 2.2.11 Service Suspensions/Restorations

2.2.11.1 Upon MCI's request through a Suspend/Restore Order, BellSouth shall suspend or restore the functionality of any Network Element, feature, function, or resale service. BellSouth shall use its best efforts to provide restoration

priority on a per network element or combination basis in a manner that conforms with MCI's requested priorities.

#### 2.2.12 Disconnects

2.2.12.1 BellSouth shall provide to MCI's daily information notifying MCI's of any services disconnected from MCI's, other than disconnections initiated by MCI's, in a mutually agreed upon format.

#### 2.2.13 Order Completion Notification

2.2.13.1 Upon completion of a service orders associated with Local Service Requests (LSRs) in its system(s), BellSouth shall submit to MCI's an order completion notifications. Such notifications shall provide the Purchase Order Numbers provided by MCI's when submitting the requests and the Local Service Request Numbers assigned by BellSouth.

#### 2.2.14 Fulfillment Process

2.2.14.1 MCI's shall conduct all activities associated with the account fulfillment process, for example welcome packages and calling cards, for all MCI's subscribers.

#### 2.2.15 *Specific Unbundling Requirements*

2.2.15.1 MCI's may order and BellSouth shall provision unbundled Network Elements either individually or in any combination on a single order. Network Elements ordered as combined shall be provisioned as combined by BellSouth unless MCI's specifies that the Network Elements ordered in combination be provisioned separately. Orders of combined Network Elements shall be subject to provisions of section 2.3 of Attachment III.

2.2.15.2 Prior to providing service in a specific geographic area or when MCI's requires a change of network configuration, MCI's may elect to place an order with BellSouth requiring BellSouth to prepare Network Elements and switch translations in advance of orders for additional network elements from MCI's.

**2.2.15.3** When MCIm orders Network Elements or Combinations that are currently interconnected and functional, Network Elements and Combinations shall remain connected and functional without any disconnection or disruption of functionality. This shall be known as Contiguous Network Interconnection of Network Elements.

**2.2.15.4** Order combinations of Contiguous Network Elements shall be available to be ordered (i) on a case-by-case basis for those Network Elements that are subscriber-specific; or (ii) on a common-use basis for those Network Elements that are shared by multiple subscribers.

**2.2.15.5** Network Elements shall be identified and ordered by MCIm so that they can be provisioned together. MCIm may specify the functionality of a combination without the need to specify the configuration of the individual Network Elements needed to provide that functionality.

**2.2.15.6** When ordering a Combination, MCIm shall have the option of ordering all features, functions and capabilities of each Network Element.

**2.2.15.7** When MCIm orders Network Elements, BellSouth shall provision at parity with services provided to BellSouth subscribers all features, functions, and capabilities of the Network Elements which include, but are not limited to:

**2.2.15.7.1** The basic switching function of connecting lines to lines, lines to trunks, trunks to lines, and trunks to trunks, as well as the same basic capabilities made available to BellSouth's subscribers, such as telephone number, white page listing, and dial tone; and

**2.2.15.7.2** All other features that the switch is equipped to provide, including, but not limited to, custom calling, custom local area signaling service features, and MULTISERV, as well as any Technically Feasible customized routing functions provided by the switch.

**2.2.15.8** When MCIm orders Network Elements, BellSouth shall provide technical assistance to ensure compatibility between elements.

2.2.15.9 Each order for Network Elements will contain administration, bill, contact, and subscriber information, as defined by the OBF.

## 2.3 Systems Interfaces and Information Exchanges

2.3.0 BellSouth shall provide real-time and interactive access via electronic interfaces as detailed in this Agreement to perform pre-service ordering, service trouble reporting, service order processing and provisioning, customer usage data transfer and local account maintenance. If any of the processes require additional capabilities, BellSouth shall develop the additional capabilities by January 1, 1997. If BellSouth cannot meet that deadline, BellSouth shall file a report with the Commission that outlines why it cannot meet the deadline, the date by which such system will be implemented, and a description of the system or process which will be used in the interim. BellSouth and MCIIm shall also establish a joint implementation team to assure the implementation of the real-time and interactive interfaces. These electronic interfaces shall conform to industry standards where such standards exist or are developed.

### 2.3.1 General Requirements

2.3.1.1 For pre-ordering and provisioning, the parties agree to implement the BellSouth approved and implemented EBI standard for Local Service Requests (LSR<sup>TM</sup>) within twelve (12) months of the implementation of the EBI interface for Access Service Request provisioning. MCIIm further agrees to accept on an interim basis, until such time as EBI is implemented for LSR, the interfaces approved by BellSouth. These interim solutions described below address the Pre-ordering, Ordering and Provisioning interfaces.

2.3.1.1.1 Until such standards are completed, BellSouth and MCIIm agree to use an interim order format and interface which will be defined by BellSouth and implementation negotiated between the Parties no later than sixty (60) days after the Effective Date of this Agreement.

2.3.1.2 BellSouth interfaces shall provide MCIIm with the same process and system capabilities for both Residence and Business ordering and provisioning. MCIIm shall not be

required to develop distinct processes or interfaces by class of service.

2.3.1.3 BellSouth and MCIm shall agree on and implement interim solutions for each interface within thirty (30) days after the Effective Date of this Agreement, unless otherwise specified in Exhibit A of this Attachment. The interim interface(s) shall, at a minimum, provide MCIm the same functionality and level of service as is currently provided by the electronic interfaces used by BellSouth for its own systems, users, or subscribers.

2.3.1.4 Interim interfaces or processes may be modified, if so agreed by MCIm and BellSouth, during the interim period.

2.3.1.5 Until the electronic interface is available, BellSouth agrees that the Local Carrier Service Center (LCSC) or similar function will accept MCIm orders. Orders will be transmitted to the LCSC via an interface or method agreed upon by MCIm and BellSouth.

2.3.1.6 BellSouth shall provide to MCIm a list of all CLASS and Custom features and functions within ten (10) days of the Effective Date of this Agreement and shall provide updates to such list at the time new features and functions become available.

## 2.3.2 Ordering and Provisioning for Resale Services

2.3.2.1 BellSouth shall make available to MCIm a list of all intraLATA and interLATA carriers available for subscriber selection on a central office level.

2.3.2.2 *Left blank intentionally.*

2.3.2.3 BellSouth shall provide MCIm with customer service records, including without limitation Customer Proprietary Network Information (CPNI), except such information as BellSouth is not authorized to release either by the customer or pursuant to applicable law, rule or regulation.

2.3.2.3.1 BellSouth shall provide to MCIm, on a restricted basis which will appropriately safeguard subscribers' privacy, a real-time, electronic interface to BellSouth's subscriber information systems which

will allow MCIm to obtain the subscriber profile information, including listed name, billing and service addresses, billed telephone number(s), and identification of features and services on the subscriber's account(s). The Parties shall mutually agree on restrictions that will appropriately safeguard subscribers' privacy.

2.3.2.3.1.1 Until access to CSRs is available via a real-time, electronic interface, BellSouth shall provide CSRs via a three-way call to a BellSouth service center or will fax a copy of the customer's record to MCIm with the customer's permission. BellSouth will also make available to MCIm the "switch-as-is" process. BellSouth will also provide information on an existing account in conjunction with issuing an LSR to convert the subscriber's service to MCIm.

2.3.2.3.1.2 BellSouth shall provide MCIm with CSR information, which may include CPNI, for preordering and ordering purposes, to the extent that BellSouth provides such information to other carriers, and upon the same terms and conditions that BellSouth uses for providing the same information to other carriers.

2.3.2.3.1.3 BellSouth shall not require MCIm to obtain prior written authorization from each customer before allowing access to the customer service records (CSRs). MCIm shall issue a blanket letter of authorization to BellSouth which states that it will obtain the customer's permission before accessing CSRs. Further BellSouth shall develop a real-time operational interface to deliver CSRs to MCIm, and the interface shall only provide the customer information necessary for MCIm to provide telecommunications service.

2.3.2.4 BellSouth shall provide to MCIm access to a list of all Telecommunications Services features and functions, including new services, trial offers, and promotions. At MCIm's option, BellSouth will provide MCIm access to



BellSouth's Products and Services Inventory Management System (P/SIMS) data via Network Data Mover file transfer. BellSouth shall update this data at least once a week from BellSouth's P/SIMS database. The data shall be available at all times and MCIIm may retrieve the data at any time on a mutually agreed upon schedule which will allow MCIIm to download the file once it is updated by BellSouth

2.3.2.5 At MCIIm's option, BellSouth will provide MCIIm the capability to validate addresses by access to BellSouth's Regional Street Address Guide (RSAG) via dial-up or LAN to WAN access. Implementation time frames will be negotiated between the parties.

2.3.2.6. BellSouth will provide MCIIm on-line access to telephone number reservations by April 1, 1997. Until on-line access is available via electronic interface, BellSouth agrees to provide MCIIm with a ready supply of telephone numbers as described in Section 2.1.8.2.

2.3.2.7 At MCIIm's option, BellSouth will provide MCIIm the capability to reserve telephone numbers electronically. Up to 100 telephone numbers per CLLI/Terminating Traffic Area may be reserved at MCIIm's request, for MCIIm's sole use. BellSouth will provide additional numbers manually at MCIIm's request in order that MCIIm will have sufficient numbers available to meet expected needs. In situations where there are limited numbers available, BellSouth may limit the number of telephone numbers that can be reserved for a particular CLLI/TTA. The telephone number reservations made in this manner are valid for MCIIm's assignment for ninety (90) days from the reservation date. BellSouth will make the telephone number reservations available to MCIIm via diskette or via electronic file transfer. BellSouth agrees to implement an electronic interface to allow MCIIm to reserve telephone numbers via an on-line electronic interface no later than April 1, 1997.

2.3.2.8 BellSouth Local Carrier Service Center (LSCS) will assign vanity numbers and blocks of numbers for use with complex services including, but not limited to, DID and Hunting arrangements, as requested by MCIIm, and documented in Work Center Interface agreements.

2.3.2.9 BellSouth will supply MCIm with Interval Guide Job Aids to be used to determine service installation dates. BellSouth will implement an electronic interface to its Due Date Support Application (DSAP) no later than April 1, 1997.

2.3.2.10 BellSouth shall provide to MCIm a real-time, on-line, electronic interface which will allow MCIm the ability to validate addresses, reserve telephone numbers, determine central office services/features and the ability to estimate due dates. This capability shall be provided no later than April 1, 1997.

2.3.2.11 BellSouth shall provide to MCIm a real-time, on-line electronic interface which will allow for entering Local Service Requests for resold services. This interface will provide MCIm the capability to retrieve Firm Order Confirmation, service order status and completion notifications.

2.3.2.12 BellSouth agrees to develop and make available to MCIm an Electronic Data Interchange (EDI) for ordering Local Services. This EDI ordering process supports select service order types and related transactions (i.e. orders, confirmations, firm order commitments, supplements and completions).

2.3.2.13 For ordering of Local Service Requests via EDI, BellSouth agrees to develop the EDI interface to be in conformance with the industry standards at such time as those standards become available. Implementation of this industry standard EDI interface will be per schedules mutually agreed to by MCIm and BellSouth.

### 2.3.3 Ordering and Provisioning for Unbundling

2.3.3.1 BellSouth shall provide to MCIm upon request a listing of all technically available functionalities for Network Elements.

2.3.3.2 BellSouth shall provide to MCIm upon request all engineering design and layout information for Network Elements.

2.3.3.3 BellSouth shall provide to MCIm a real-time, electronic interface which will allow MCIm to determine

service due date intervals, schedule appointments, and adjust pending order due dates in real-time.

2.3.3.4 BellSouth shall provide to MCIm upon request advance information of the details and requirements for planning and implementation of NPA splits at least 6 months prior to implementation of the split.

2.3.3.5 BellSouth shall provide to MCIm information on charges associated with special construction. Until real-time, electronic interface is available, BellSouth agrees that BellSouth will immediately notify MCIm of any charges associated with necessary construction.

2.3.3.6 BellSouth shall provide MCIm with results from mechanized loop tests.

2.3.3.7 BellSouth shall provide MCIm with confirmation of circuit assignments.

## 2.4 Standards

### 2.4.1 General Requirements

2.4.1.1 MCIm and BellSouth shall use the OBF standards for ordering and provisioning codes to be used for Network Elements. These codes shall apply to all aspects of the unbundling of elements and shall be known as data elements as defined by the Telecommunications Industry Forum Electronic Data Interchange Service Order Subcommittee (TCIF-EDI-SOSC). Some unbundled Network Elements will continue to be ordered utilizing the ASR process.

## 2.5 Performance Measurements and Reporting

2.5.1 In providing Services and Elements, BellSouth will provide MCIm with the quality of service BellSouth provides to itself and its end-users. BellSouth's performance under this Agreement shall provide MCIm with the capability to meet standards or other measurements that are at least equal to the level that BellSouth provides or is required to provide by law or its own internal procedures, whichever is higher. BellSouth shall satisfy all service standards, measurements, and performance requirements set forth in the Agreement and the performance standards that are specified

in Attachment 8 of this Agreement. In the event that BellSouth demonstrates that the level of performance specified in Attachment 8 of this Agreement are higher than the standards or measurements that BellSouth provides to itself and its end users pursuant to its own internal procedures, BellSouth's own level of performance shall apply.

2.5.1.1 The Parties acknowledge that the need will arise for changes to the performance standards specified in Attachment 8 during the term of this Agreement. Such changes may include the addition or deletion of measurements or a change in the performance standard for any particular metric. The parties agree to review all performance standards on a quarterly basis to determine if any changes are appropriate.

2.5.1.2 The Parties agree to monitor actual performance on a monthly basis and develop a Process Improvement Plan to continually improve quality of service provided as measured by the performance standards.

2.5.2 BellSouth, in providing Services and Elements to MCIm pursuant to this Agreement, shall provide MCIm the same quality of service that BellSouth provides itself and its end-users. This attachment includes MCIm's minimum service standards and measurements for those requirements. The Parties have agreed to five (5) categories of performance standards: (1) Provisioning; (2) Maintenance; (3) Billing (Data Usage and Data Carrier); (4) LIDB; and (5) Account Maintenance. Each category of performance standards include measurements which focus on timeliness, accuracy and quality. BellSouth shall measure the following activities to meet the goals provided herein.

2.5.2.1 All performance standards shall be measured on a monthly basis and shall be reported to MCIm in a mutually agreed upon format which will enable MCIm to compare BellSouth's performance for itself with respect to a specific measure to BellSouth's performance for MCIm for that same specific measure. Separate measurements shall be provided for residential subscribers and business subscribers.

2.5.2.2 Performance standards being measured pursuant to this Agreement shall be reviewed by MCIm and BellSouth quarterly to determine if any additions or

changes to the measurements and the standard shall be required or, if process improvements shall be required.

### 2.5.3 Provisioning Performance Standards

2.5.3.1 Installation functions performed by BellSouth will meet the following performance standards:

MCImetro - BellSouth Florida Interconnection Agreement

<b>Product or Service</b>	<b>Interval Standards</b>
<b>INSTALLATION</b>	
<b>Lines/trunks with no premises visit:</b>	
<i>Business</i>	
1-20 lines	98% met within 3 business days
21-40 lines	98% met within 7 business days
41-60 lines	98% met within 12 business days
Over 60 lines	To be negotiated
<i>Residential</i>	98% met within 24 hours of Service Order receipt by BellSouth
<b>Lines/trunks with premises visit:</b>	
<i>Business</i>	
1-20 lines	98% met within 5 business days
21-40 lines	98% met within 10 business days
41-60 lines	98% met within 14 business days
Over 60 lines	Individual case basis
<i>Residential</i>	98% met within 72 hours of Service Order receipt by BellSouth
<b>Business lines/trunks; plant or other facilities not available</b>	Individual case basis
<b>Centrex station lines</b>	
1-20 lines	98% met within 5 business days
21-50 lines	98% met within 8 business days
Over 50 lines	Individual case basis
<b>Unbundled network elements</b>	
<i>Business or Residential</i>	98% met within 2 days
<b>Other unbundled elements</b>	

<i>Business or Residential</i>	98% met within 5 days
<b>FEATURE CHANGES</b>	
Orders received before 12:00 p.m.	99% completed on day of receipt
Orders received after 12:00 p.m.	99% completed before 12:00 p.m. next Business Day

<b>Product or Service</b>	<b>Interval</b>
<b>SERVICE DISCONNECTS</b>	
<b>With no premises visits</b>	
<i>Business or Residential</i>	98% met within within 4 hours after receipt of Service Order
<b>With CO change or subscriber premises visit</b>	
<i>Business or Residential</i>	98% met within 24 hours after receipt of Service Order
<b>Unbundled switching elements</b>	
<i>Business or Residential</i>	98% met within 4 hours
<b>Other unbundled elements</b>	
<i>Business or Residential</i>	98% met within 24 hours

**Committed Due Date**

**Resale:**

Residence: >99% met

Business: >99.5% met

UNE: > 98% met

**Service Orders Provisioned Correctly as Requested**

**Resale:**

Residence: >99% met

Business: > 99.5% met

MCImetro - BellSouth Florida Interconnection Agreement

UNE: > 99% met

Missed Appointments

Residence: < 1%

Business: 0%

Firm Order Confirmation within:

Manual - within 24 hours 99% of the time

Electronic - within 4 hours 99% of the time

Notice of reject or error status within 1 hour  
of receipt 98% of the time

No trouble reports within 30 days of installation -  
99% of the time

Time to complete any Suspend/Block/Restore order  
4 hours > 99% after receipt by BellSouth

For expedited due date confirmation, BellSouth shall confirm to MCIm within two (2) Business Hours > 99% after BellSouth receipt of such request from MCIm whether BellSouth can complete an initially-submitted order within the expedited interval requested by MCIm. Confirmation may be provided by BellSouth via telephone call with follow up confirmation to be provided by BellSouth according to normal procedures and measurement intervals.

**2.5.4 BellSouth shall implement the performance measurements indicated in section 2.5 within six (6) months of the Effective Date of this Agreement.**

**2.5.5 If MCIm requests, in writing, a higher level of performance than BellSouth provides to its own subscribers, BellSouth shall inform MCIm, in writing, of the amount MCIm's desired performance level exceeds that which BellSouth provides to its subscribers as well as a reasonable estimate of what it would cost BellSouth to meet, measure, and report these standards. If MCIm then communicates, in writing, to BellSouth that it desires such higher levels of performance, MCIm shall pay BellSouth for the costs incurred in providing such higher level of service. Moreover, MCIm shall pay all mechanisms necessary to capture and report data, required to measure, report or track any performance measurement that BellSouth does not, as of the Effective Date,**



measure, report or track for itself or its own subscribers. In the event such system is not developed exclusively for MCIm, but rather is developed for use with other CLECs, as well as MCIm, BellSouth shall allocate to MCIm, on a competitively neutral basis, MCIm's share of the costs associated with such system.

### **Section 3. Connectivity Billing and Recording**

This Section 3 describes the requirements for BellSouth to bill and record all charges MCIm incurs for purchasing services under this Agreement.

#### **3.1 Procedures**

3.1.1 BellSouth shall comply with various industry, OBF, and other standards referred to throughout this Agreement. To satisfy these requirements, both parties shall adhere to mutually agreed upon interpretations of all standards referred to in this Agreement.

3.1.2 BellSouth shall record and bill in accordance with this Agreement those charges MCIm incurs as a result of MCIm purchasing from BellSouth services, as set forth in this Agreement (hereinafter "Connectivity Charges").

3.1.3. BellSouth will bill charges for interconnection and resale (within 180 days of the execution of this agreement) in a CABS format. BellSouth will conform each CABS bill in accordance with CABS guidelines.

3.1.4 Each service purchased by MCIm shall be assigned a separate and unique billing code in the form agreed to by the parties and such code shall be provided to MCIm on each Connectivity Bill in which charges for such services appear.

3.1.4.1 Each such billing code shall enable MCIm to identify the service as ordered by MCIm.

3.1.5 Each Connectivity Bill shall set forth the quantity and description of each such service provided and billed to MCIm. All Connectivity Charges billed to MCIm shall indicate the state from which such charges were incurred.

3.1.6 BellSouth shall bill MCIm for each service supplied by BellSouth to MCIm pursuant to this Agreement at the rates forth in this Agreement.

3.1.7 BellSouth shall bill MCI for the Connectivity Charges incurred; provided that, for those usage based Connectivity Charges where actual charge information is not determinable by BellSouth because the jurisdiction (i.e., interstate, interstate/interLATA, intrastate, intrastate/ intraLATA, local) of the traffic is unidentifiable, or for other reason, the parties shall jointly develop a process to determine the appropriate charges.

3.1.8 Measurement of usage-based Connectivity Charges shall be in actual conversation seconds. The total conversation seconds per chargeable traffic types shall be totaled for the entire monthly bill cycle and then rounded to the next whole minute. State tariffs apply for resold usage plans.

3.1.9 BellSouth shall provide to MCI at no additional charge a Single Point of Contact through a Local Carrier Service Center (LCSC), or similar function, for handling any Connectivity Billing questions or problems that may arise during the implementation and performance of the terms and conditions of this Agreement.

3.1.10 BellSouth shall provide single point of contact for handling of any data exchange questions or problems that may arise during the implementation and performance of the terms and conditions of this Agreement.

3.1.11 As soon as possible after completion of this Agreement, each party shall provide the other party written notice of which form of the monthly Connectivity Bill is to be deemed the official bill to assist the parties in resolving any conflicts that may arise between the official bill and another form of bill received via a different media which purportedly contain the same charges as are on the official bill.

3.1.12 If either party requests an additional copy(ies) of a bill, such party shall pay the other party a reasonable fee per additional bill copy, unless such copy was requested due to errors, omissions, or corrections or the failure of the transmission to comply with the specifications set forth in this Agreement.

3.1.13 When sending Connectivity Bills via electronic transmission, to avoid transmission failures or the receipt of Connectivity Billing information that cannot be processed, MCI shall provide BellSouth process specifications. Both parties shall comply with processing specifications when transmitting Connectivity Billing data to each other. Both parties shall provide notice to the other party if a Connectivity Billing transmission is received that does not

meet specifications or that such party cannot process. Such transmission shall be corrected and resubmitted to the other party, at the resubmitting party's sole expense, in a form that can be processed. The payment due date for such resubmitted transmissions shall be thirty (30) days from the issue date of the bill in a form that can be processed and that meets the specifications set forth in this Attachment.

**3.1.14** BellSouth shall deliver to a location specified by MCIm, billing information via Network Data Mover (NDM), magnetic tape or paper, as agreed to by MCIm and BellSouth. In the event of an emergency, system failure or other such condition which prevents BellSouth from transmitting via NDM, BellSouth shall notify MCIm of such difficulties within twenty four (24) hours of detection. BellSouth shall deliver to a location specified by MCIm billing information via magnetic tape or paper, as agreed to by MCIm and BellSouth. The parties acknowledge that all tapes transmitted to the other party via US Mail or Overnight Delivery and which contain Connectivity Billing data shall not be returned to the sending party.

**3.1.15** Subject to the terms of this Agreement, including without limitation Section 3.1.18 of this Attachment VIII, MCIm shall pay BellSouth within thirty (30) days from the issue date of the bill. If the payment due date is a Saturday, Sunday or has been designated a bank holiday payment shall be made the next business day.

**3.1.16** Left Blank Intentionally

**3.1.17** Left Blank Intentionally

**3.1.18** Bill Reconciliation

**3.1.18.1** Each party agrees to notify the other party upon the discovery of a billing discrepancy "Notice of Discrepancy".

**3.1.18.2** In the event of such Notice of Discrepancy, the parties shall endeavor to resolve the discrepancy within sixty (60) calendar days notification using normal business procedures. If the discrepancy is disputed, resolution of such dispute is expected to occur at the first level of management resulting in a recommendation for settlement of the dispute and closure of a specific billing period.

**3.1.18.3** Closure of a specific billing period shall occur by joint Agreement of the parties whereby the parties agree that such billing period is closed to any further analysis and financial transactions, except those resulting from an Audit. Closure shall take place within nine (9) months of the Bill Date. The month being closed represents those Connectivity Charges that were billed or should have been billed by the respective Bill Date.

**3.1.18.4** If the dispute is not resolved within the allotted time frame, the following resolution procedure shall begin:

**3.1.18.4.1** If the dispute is not resolved within sixty (60) days of the Notice of Discrepancy, the dispute shall be escalated to the second level of management for resolution.

**3.1.18.4.2** If the dispute is not resolved within ninety (90) days of Notice of Discrepancy, the dispute shall be escalated to the third level of management for resolution.

**3.1.18.4.3** If the dispute is not resolved within one hundred and twenty (120) days of the Notice of Discrepancy, the dispute may be resolved pursuant to Section 23 (Dispute Resolution Procedures) of Part A of this Agreement.

**3.1.18.5** If MCIm disputes Connectivity Charges and the dispute is resolved in favor of MCIm, BellSouth shall credit the Connectivity Bill of MCIm for the amount of the disputed charges.

**3.1.19** BellSouth shall reimburse MCIm for incorrect Connectivity Billing charges including without limitation: overcharges, services ordered or requested but not delivered, interrupted services, services of poor quality; and installation problems if caused by BellSouth. Such reimbursements shall be set forth in the appropriate section of the Connectivity Bill pursuant to CABS, or SECAB standards.

**3.1.20** Left Blank Intentionally

**3.1.21** When MCIm collocates with BellSouth in BellSouth's facility as described in this Agreement, capital expenditures (e.g., costs associated with building the "cage"), shall not be included in the

Connectivity Bill provided to MCIm pursuant to this Attachment VIII. All such capital expenses shall be given a unique BAN and invoice number. All invoices for capital expenses shall be sent to the location specified by MCIm for payment. All other non-capital recurring collocation expenses shall be billed to MCIm in accordance with this Agreement. (The CABS Billing Output Specifications ("BOS") documents provide the guidelines on how to bill the Connectivity Charges associated with collocation.) The bill label for such collocation charges shall be entitled "Expanded Interconnection Service." The bill label for non-capital recurring collocation expenses shall be entitled "Collocation."

3.1.22 LEC shall be responsible for billing and collecting charges from IXCs for access related to interexchange calls generated by resale subscribers.

3.1.23 When MCIm owns the end office, BellSouth shall not bill RIC to either MCIm or other IXCs.

3.1.24 Left Blank Intentionally

3.1.25 BellSouth shall establish a switched access meet point billing arrangement with MCIm. This arrangement will include tandem routed IXC calls and IXC calls routed through a line that is ported via Remote Call Forward (RCF) or FLEX DID from the BellSouth to MCIm.

3.1.25.1 MCIm will bill for carrier common line, local switching, RIC, and its portion of the transport charges for tandem routed IXC calls. For lines that are ported from the BellSouth to MCIm, BellSouth will bill only transport charges. MCIm will bill for all other applicable access charges.

3.1.25.2 BellSouth and MCIm will provide all necessary switched access records to each other for access billing.

## 3.2 Information Exchange and Interfaces

3.2.1 BellSouth shall provide MCIm monthly Connectivity Bills that include all Connectivity Charges incurred by and credits and/or adjustments due to MCIm for those services ordered, established, utilized, discontinued or performed pursuant to this Agreement. BellSouth shall issue multiple bills per month, on the first day of the month until otherwise notified by MCIm and the billing cycle shall be on a calendar basis. Each Connectivity Bill provided by BellSouth to MCIm shall include:

3.2.1.1 all non-usage sensitive charges incurred for the period beginning with the day after the current bill date and extending to, and including, the next bill date;

3.2.1.2 any known unbilled non-usage sensitive charges for prior periods;

3.2.1.3 unbilled usage sensitive charges for the period beginning with the last bill date and extending up to, but not including, the current bill date for interconnection and extending through the bill date for resold services;

3.2.1.4 any known unbilled usage sensitive charges for prior periods;

3.2.1.5 any known unbilled adjustments.

3.2.1.6 Interim Number Portability. MCIIm shall become the Customer of Record for the original BellSouth's telephone number(s). BellSouth shall use its reasonable efforts to provide MCIIm with a consolidated billing statement for all collect and billed-to-3rd-number calls associated with those numbers, with sub-account detail by retained number. Such billing statements shall be delivered in the Carrier Access Billing System/Small Exchange Carrier Access Billing System ("CABS/SECABS") format when defined by the Ordering and Billing Forum ("OBF").

3.2.2 BellSouth shall make available during normal business days, pursuant to Section 4 of this Attachment, usage call detail information.

3.2.3 The Bill Date must be present on each bill transmitted by BellSouth to MCIIm, must be a valid calendar date, and not more than one (1) year old. Connectivity Bills shall not be rendered for any Connectivity Charges which are incurred under this Agreement on or before one (1) year preceding the Bill Date, except as otherwise permitted by law.

3.2.4 On each bill where 'Jurisdiction' is identified, local and local toll charges shall be identified as 'Local' and not as interstate, interstate/ interLATA, intrastate, or intrastate/intraLATA. BellSouth shall provide from and through dates for charges rendered on all Connectivity Bills.

3.2.5 BellSouth shall separately identify, via USOCs, business charges from residence charges, as appropriate, and shall assign a specific adjustment or reference number provided by MCI to each adjustment and credit included on the Connectivity Bill.

3.2.6 Left Blank Intentionally

3.2.7 BellSouth and MCI shall issue all Connectivity Bills in accordance with the terms and conditions set forth in this Section 3. On Connectivity Bills BellSouth renders to MCI, BANs shall be 13 character alpha/numeric. The Bill Date shall be the same day month to month. Each party shall provide the other party at least thirty (30) calendar days written notice prior to changing, adding or deleting a BAN. The parties shall provide one Connectivity Billing invoice associated with each BAN. Each invoice must contain an invoice number (which will vary from month to month). On each bill associated with a BAN, the appropriate invoice number and the charges contained on such invoice must be reflected. All Connectivity Bills must be received by the other party no later than ten (10) calendar days from Bill Date and at least twenty (20) calendar days prior to the payment due date (as described in this Attachment), whichever is earlier. Any Connectivity Bill received on a Saturday, Sunday or a day designated as a bank holiday will be deemed received the next business day. If either party fails to receive Connectivity Billing data and information within the time period specified above the payment due date will be extended by the number of days receipt has been delayed.

3.2.8 BellSouth shall make best efforts to issue all Connectivity Bills containing such billing data and information in accordance with the most current version of CABS /SECABS published by Bellcore, or its successor, or such later versions as are adopted by Bellcore, or its successor. To the extent that there are no CABS, or SECAB standards governing the formatting of certain data, such data shall be issued in the format mutually agreed to by BellSouth and MCI.

3.2.9 BellSouth and MCI agree that each party shall transmit Connectivity Billing information and data in the appropriate CABS or SECAB format electronically via NDM to the other party at the location specified by such party. MCI data centers will be responsible for originating the calls for data transmission. BellSouth shall transmit in accordance with mutually agreed to technical specifications. MCI will supply to BellSouth its RACF ID and password before the first transmission of data via NDM. Any changes to either party's NDM Node ID must be sent to the other

MCImetro - BellSouth Florida Interconnection Agreement

party no later than thirty (30) calendar days before the changes take effect.

3.2.10 In emergency situations when tape transmittal has been used BellSouth shall adhere to the tape packaging requirements set forth in this Agreement. Where magnetic tape shipping containers are transported in freight compartments, adequate magnetic field protection shall be provided by keeping a 6-inch distance from any magnetic field generating device (except a magnetron-tape device). BellSouth shall only use those shipping containers that contain internal insulation to prevent damage. BellSouth shall clearly mark on the outside of each shipping container its name, contact and return address. BellSouth shall not ship any Connectivity Billing tapes in tape canisters.

3.2.11 All emergency billing data transmitted via tape must be provided on a cartridge (cassette) tape and must be of high quality, conform to the parties' record and label standards, 9-track, odd parity, 6250 BPI group coded recording mode and extended binary-coded decimal interchange code ("EBCDIC"). Each reel of tape must be 100% tested at 20% or better "clipping" level with full width certification and permanent error free at final inspection. MCIm reserves the right to destroy a tape that has been determined to have unrecoverable errors. MCIm also reserves the right to replace a tape with one of equal or better quality.

3.2.12 Billing data tapes used in emergency circumstances shall have the following record and label standards. The dataset serial number on the first header record of an IBM standard tape label also shall have the following format.

	<b>CABS BOS</b>	<b>SECAB</b>
<b>Record Length</b>	bytes (fixed length)	bytes (fixed length)
<b>Blocking factor</b>	records per block	Not Applicable
<b>Block size</b>	bytes per block	Not Applicable
<b>Labels</b>	Standard IBM Operating System	Standard IBM Operating System



**3.2.13 A single 6-digit serial number must appear on the external (flat) surface of the tape for visual identification. This number shall also appear in the "dataset serial number field" of the first header record of the IBM standard tape label. This serial number shall consist of the character "V" followed by the reporting location's four digit Originating Company Code and a numeric character chosen by the sending company. The external and internal label shall be the same. The dataset name shall appear on the flat side of the reel and also in the "data set name field" on the first header record of the IBM standard tape label. BellSouth's name, address, and contact shall appear on the flat side of the cartridge or reel**

**3.2.14 Tape labels shall conform to IBM OSNS Operating System Standards contained in the IBM Standard Labels Manual. IBM standard labels are 80-character records recorded in EBCDIC, odd parity.**

**3.2.15 BellSouth shall conform to the Standard Volume Label Format which will be prescribed by MCI.**

**3.2.16 BellSouth shall use The IBM Standard Dataset Label Format which will be prescribed by MCI**

**3.2.17 BellSouth shall use mutually agreed upon test & production dataset formats**

### **3.3 Standards**

**3.3.1 Within thirty (30) days of the execution of this Agreement, BellSouth shall send to MCI connectivity bill data in the appropriate mechanized format (i.e. CABS or SECAB) for testing to ensure that bills can be processed and that bills comply with the requirements of this Attachment. After receipt of the test data from BellSouth MCI will notify BellSouth if the connectivity billing transmission meets MCI's testing specifications. If the transmission fails to meet MCI's testing specifications, BellSouth shall make the necessary corrections. At least three (3) sets of testing data must meet MCI's testing specifications prior to BellSouth sending MCI a mechanized production connectivity bill for the first time via electronic transmission or tape. Thereafter, BellSouth may begin sending MCI production connectivity bills via electronic transfer on the next Bill Date, or within ten (10) days, whichever is later.**

**3.3.2 At least thirty (30) days prior to any change in existing formats or change to a different format, BellSouth shall send to**

MCIIm connectivity bill data in the appropriate mechanized format for testing to ensure that the bills can be processed and that the bills comply with the requirements of this Attachment. BellSouth agrees that it shall not send to MCIIm bill data in the new mechanized format until such bill data has met the testing specifications as set forth in this subsection.

3.3.3 During the testing period, BellSouth shall transmit to MCIIm Connectivity Billing data and information via paper or tape as specified by MCIIm. Test tapes shall be sent to a MCIIm specified location.

3.3.4 BellSouth agrees that if it transmits data to MCIIm in a mechanized format, BellSouth shall also comply with the following specifications which are not contained in CABS or SECAB guidelines but which are necessary for MCIIm to process Connectivity Billing information and data:

3.3.5 The Bill Date shall not contain spaces or non-numeric values.

3.3.5.1 Each Connectivity Bill must contain at least one detail record.

3.3.5.2 Any “From” Date should be less than the associated “Thru” Date and neither date can contain spaces.

3.3.5.3 The Invoice Number must not have embedded spaces or low values.

3.3.6 LEFT BLANK INTENTIONALLY

3.3.7 LEFT BLANK INTENTIONALLY

#### **3.4 Performance Measurements & Reporting**

**3.4.1 BellSouth shall meet the following performance measurements for the provision of EMR records:**

**3.4.1.1 Timeliness: 99.94% of all records recorded each day shall be received by MCIIm within one (1) calendar day of their recording. 100% of all such records should be received within five (5) calendar days of their recording.**

**3.4.1.2 Accuracy: No more than 60 errors per one (1) million records transmitted**

**3.4.1.3 Completeness:** *There shall be no more than 20 omissions per one (1) million records.*

**3.4.2** If MCI<sub>m</sub> requests, in writing, a higher level of performance than BellSouth provides to its own subscribers, BellSouth shall inform MCI<sub>m</sub>, in writing, of the amount MCI<sub>m</sub>'s desired performance level exceeds that which BellSouth provides to its subscribers as well as a reasonable estimate of what it would cost BellSouth to meet, measure, and report these standards. If MCI<sub>m</sub> then communicates, in writing, to BellSouth that it desires such higher levels of performance, MCI<sub>m</sub> shall pay BellSouth for the costs incurred in providing such higher level of service. Moreover, MCI<sub>m</sub> shall pay all mechanisms necessary to capture and report data, required to measure, report or track any performance measurement that BellSouth does not, as of the Effective Date, measure, report or track for itself or its own subscribers. In the event such system is not developed exclusively for MCI<sub>m</sub>, but rather is developed for use with other CLECs, as well as MCI<sub>m</sub>, BellSouth shall allocate to MCI<sub>m</sub>, on a competitively neutral basis, MCI<sub>m</sub>'s share of the costs associated with such system.

#### **Section 4 Provision Of Subscriber Usage Data**

This Section 4 sets forth the terms and conditions for BellSouth's provision of Recorded Usage Data (as defined in this Attachment VIII) to MCI<sub>m</sub> and for information exchange regarding long distance billing.

##### **4.1 Procedures**

###### **4.1.1 General**

**4.1.1.1** BellSouth shall comply with BellSouth EMR industry standards in delivering customer usage data to MCI<sub>m</sub>.

**4.1.1.2** BellSouth shall provide MCI<sub>m</sub> with Recorded Usage Data in accordance with provisions of Section 4 of this document.

**4.1.1.3** BellSouth shall provide MCI<sub>m</sub> with copies of detail usage on MCI<sub>m</sub> accounts. However, following execution of this Agreement, MCI, may submit and BellSouth will accept a PON for a time and cost estimate for development by BellSouth of the capability to provide copies of other detail

usage records for completed calls originating from lines purchased by MCI for resale. Recorded Usage Data includes, but is not limited to, the following categories of information:

**Completed Calls**

**Use of CLASS/LASS/Custom Features (under circumstances where BellSouth records activations for its own end user billing).**

**Calls To Information Providers Reached Via BellSouth Facilities And Contracted By BellSouth**

**Calls To Directory Assistance Where BellSouth Provides Such Service To An MCI Subscriber**

**Calls Completed Via BellSouth-Provided Operator Services Where BellSouth Provides Such Service To MCI's Local Service Subscriber and usage is billable to an MCI account. For BellSouth-Provided MULTISERV Service, Station Level Detail Records Shall Include Complete Call Detail And Complete Timing Information where Technically Feasible.**

**4.1.1.4 Retention of Records: BellSouth shall maintain a machine readable back-up copy of the message detail provided to MCI for a minimum of forty-five (45) calendar days. BellSouth shall provide any data back-up to MCI upon the request of MCI within the record retention interval and at the rates set forth in Attachment I.**

**4.1.1.5 BellSouth shall provide to MCI Recorded Usage Data for MCI subscribers. BellSouth shall not submit other carrier local usage data as part of the MCI Recorded Usage Data.**

**4.1.1.6 BellSouth shall bill to MCI any recurring or non-recurring charges appropriate based on the Local Service Requests submitted to the BellSouth by MCI. BellSouth**

**4.1.1.7 MCI shall negotiate with Information Service Providers (e.g. 976 and N11 service calls) for provision of such services to MCI's end-users, including the billing of such services to its end-users.**

**4.1.1.8 BellSouth shall provide Recorded Usage Data to MCI billing locations as designated by MCI, segregated no lower than NXX level.**

4.1.1.9 BellSouth shall establish a Local Carrier Service Center (LCSC) or similar function to serve as MCIm's single point of contact to respond to MCIm call usage, data error, and record transmission inquiries.

4.1.1.10 BellSouth shall provide MCIm with a single point of contact, Remote Identifiers (IDs), and assistance in resolving usage data volume fluctuations for each sending location.

4.1.1.11 MCIm shall provide a single point of contact responsible for receiving usage transmitted by BellSouth and receiving usage tapes from a courier service in the event of a facility outage.

4.1.1.12 BellSouth shall bill and MCIm shall pay the charges for Recorded Usage Data. Billing and payment shall be in accordance with the applicable terms and conditions set forth in this Agreement.

4.1.1.13 Without waiver of, and in addition to the Audit and Examination rights in the Section 22 (Audits and Examinations of Part A) of this Agreement, upon reasonable notice and at reasonable times MCIm or its authorized representatives may examine BellSouth's documents, systems, records and procedures which relate to the recording and transmission of the Usage data to MCIm under this Attachment.

#### 4.1.2 Charges

4.1.2.1 BellSouth shall charge fees as delineated in Attachment I.

4.1.2.2 No charges shall be assessed for incomplete call attempts, nor will attempts be delivered to MCIm for calls which originate from lines purchased by MCIm for resale.

#### 4.1.3 Central Clearinghouse & Settlement

4.1.3.1 In connection with CMDS hosting functions, BellSouth shall comply with Clearinghouse and Incollect/Outcollect procedures in accordance with CMDS standards.

4.1.3.2 BellSouth shall settle with MCIm for both intra-region and inter-region billing exchanges of calling card, bill-to-third party, and collect calls in accordance with the prevailing CMDS standards.

4.1.4 Lost Data

4.1.4.1 Loss of Recorded Usage Data - In the event MCIm Recorded Usage Data is determined to have been lost, damaged or destroyed as a result of an error or omission by BellSouth in its performance of the recording function, upon MCIm's request, BellSouth shall attempt to recover the Recorded Usage Data at no charge to MCIm. In the event the data cannot be recovered by BellSouth, BellSouth and MCIm shall mutually agree upon a credit amount based upon an estimate of the affected messages and associated revenue, reduced by a mutually agreed upon estimate of associated Recording Service charges, based upon the method described below. This method shall be applied on a consistent basis, subject to modifications agreed to by BellSouth and MCIm. This estimate shall be used to adjust amounts MCIm owes BellSouth for services BellSouth provides in conjunction with the provision of Recorded Usage Data, and BellSouth's liability for lost, damaged or destroyed Recorded Usage Data shall be limited to the application of the credit described in this section.

4.1.4.2 The lost revenue per day will be based upon the daily average of revenues for the corresponding days of the week (e.g. four Mondays) in the most recent month for which MCIm supplied data to BellSouth before the day of loss, except:

4.1.4.2.1 If the loss occurs on a weekday which is a holiday (except Mother's Day or Christmas), BellSouth will use the daily average of revenues from the four Sundays of the most recent month for which MCIm supplied data to BellSouth before the day of loss;

4.1.4.2.2 If the loss occurs on Mother's Day or Christmas, BellSouth will use the daily average of revenue from that day in the preceding year (if

available from the data supplied by MCIm to BellSouth before the day of loss); and

4.1.4.2.3 If the loss occurs on a day not a holiday but one (or more) of the days lost is a holiday, BellSouth will use additional corresponding days from the next most recent month for which MCIm supplied data to BellSouth before the day of loss.

#### 4.1.5 Testing, Changes and Controls

4.1.5.1 The Recorded Usage Data, EMR format, content, and transmission process shall be tested in a manner mutually agreed upon by BellSouth and MCIm.

4.1.5.2 Interface Testing: The purpose of this test is to ensure that the usage records can be sent by BellSouth to MCIm and can be accepted and processed by MCIm. BellSouth shall provide a test file to MCIm's designated Regional Processing Center (RPC) in the format that shall be used for live day-to-day processing. The file shall contain that production data which MCIm and BellSouth agree upon. MCIm shall review the file and verify that it conforms to agreed upon EMR standards. MCIm shall notify BellSouth in writing whether the format is acceptable. MCIm shall also provide BellSouth with the agreed-upon control reports as part of this test.

4.1.5.3 Operational Test: The purpose of this test is to ensure that volumes of usage in consecutive sequence can be extracted, distributed, and processed by BellSouth and MCIm.

4.1.5.4 For testing purposes BellSouth shall provide MCIm with BellSouth recorded, unrated usage for a minimum of five (5) consecutive days. MCIm shall provide BellSouth with the message validation reports associated with test usage.

4.1.5.5 Test File: Test data should be transported via NDM whenever possible. In the event that courier service must be used to transport test media, the physical tape characteristics to be used are described in this Agreement.

4.1.5.6 Periodic Review: Control procedures for all usage transferred between BellSouth and MCIm shall require

periodic review. This review may be included as part of an annual audit of BellSouth by MCIm or as part of the normal production interface management function. Breakdowns which impact the flow of usage between BellSouth and MCIm must be identified and jointly resolved as they occur. The resolution may include changes to control procedures, as similar problems would be avoided in the future. Any changes to control procedures would need to be mutually agreed upon by MCIm and BellSouth.

**4.1.5.7 BellSouth Software Changes:**

**4.1.5.7.1** When BellSouth plans to introduce any software changes which impact the format or content structure of the usage data feed to MCIm, designated BellSouth personnel shall notify MCIm no less than one hundred twenty (120) calendar days before such changes are implemented.

**4.1.5.7.2** BellSouth shall communicate the projected changes to the single point of contact in MCIm so that potential impacts on MCIm processing can be determined.

**4.1.5.7.3** MCIm personnel shall review the impact of the change on the entire control structure and the Post Conversion Test Plan, herein. MCIm shall negotiate any perceived problems with BellSouth and shall arrange to have the data tested utilizing the modified software.

**4.1.5.7.4** If it is necessary for BellSouth to request changes in the schedule, content or format of usage data transmitted to MCIm, BellSouth shall notify MCIm. BellSouth and MCIm agree to comply with changes in EMR standard as they from time to time occur.

**4.1.5.8 MCIm Requested Changes:**

**4.1.5.8.1** MCIm may request changes in the schedule, content, format of the usage data transmitted from BellSouth, as deemed necessary by MCIm within the constraints of EMR industry standard requirements.



4.1.5.8.2 When the negotiated changes are to be implemented, MCI and/or BellSouth shall arrange for testing of the modified data in a mutually agreed Post Conversion Test Plan designed to encompass all types of changes to the usage data transferred by BellSouth to MCI and the methods of transmission for that data.

**4.1.5.9 BellSouth System Change Description:**

4.1.5.9.1 For a BellSouth change to the Recorded Usage Data, BellSouth shall provide MCI with an overall description of the change, stating the objective and a brief explanation of the reasons for the change.

4.1.5.9.2 During the initial negotiations regarding the change, BellSouth shall provide a list of the specific records and/or systems impacted by the change to designated MCI personnel.

4.1.5.9.3 BellSouth shall also provide MCI a detailed description of the changes to be implemented. It shall include sufficient detail for designated MCI personnel to analyze and estimate the effects of the changes and to design tests to verify the accuracy of the implementation.

**4.1.5.10 Change Negotiations:**

4.1.5.10.1 MCI shall be notified in writing of all proposed negotiations initiated by BellSouth. In turn, MCI shall notify BellSouth in writing of proposed change negotiations initiated by MCI. These written notifications will be directed to the single point of contact for the respective companies.

4.1.5.10.2. After formal notification of planned changes, whether originated by BellSouth or MCI, designated MCI personnel shall schedule negotiation meetings as required with designated BellSouth personnel. The first meeting should produce the overall change description (if not previously furnished) and the list of records and/or systems affected.

4.1.5.10.3 In subsequent meetings, BellSouth shall provide the detailed description of changes to be implemented. After reviewing the described changes, designated MCIm personnel shall negotiate a detailed test procedure with BellSouth.

4.1.5.11 Changes to controls:  
MCIm may request changes to the control structure.  
BellSouth Requested control changes will be negotiated.

#### 4.1.5.12 Verification Of Changes

4.1.5.12.1 Based on the detailed description of changes furnished by BellSouth, MCIm and BellSouth personnel shall:

Determine the type of change(s) to be implemented.  
Develop a comprehensive test plan.  
Negotiate scheduling and transfer of modified data with BellSouth.  
Confirm that test data is verified and acceptable by both BellSouth and MCIm.

#### 4.1.5.13 Introduction of Changes:

4.1.5.13.1 When all the testing requirements have been met and the results reviewed and accepted, designated MCIm and BellSouth personnel shall:

Negotiate an implementation schedule.  
Verify the existence of a contingency plan with the appropriate MCIm personnel.  
Arrange for the follow-up review of changes with appropriate MCIm personnel.  
Arrange for appropriate changes in control program, if applicable.

## 4.2 Information Exchange and Interfaces

### 4.2.1 Core Billing Information

4.2.1.1 Recorded Usage Data all intraLATA toll and local usage. BellSouth shall provide MCIm with unrated EMR records associated with all billable intraLATA toll and local

usage which they record on lines purchased by MCIm for resale. Any billable Category, Group and/or Record types approved in the future for BellSouth shall be included if they fall within the definition of local service resale. MCIm shall be given notification thirty (30) days prior to implementation of a new type, category and / or record.

4.2.1.2 BellSouth shall provide rated EMR records only when explicit consent for sending such records has been obtained from MCIm. The following records shall be rated by BellSouth:

Category 01	Operator handled, person to person, collect calls, bill to third number, SSP record query
Category 03	Credit & adjustments
Category 41	Subscriber credit

4.2.1.3 All messages billable to an MCIm account will BellSouth be transmitted to MCIm. BellSouth recorded usage billable to MCIm Subscribers.

4.2.1.4 Data Delivery Schedules: Data shall be delivered to MCIm by BellSouth daily (Monday through Friday) unless otherwise negotiated. MCIm and/or BellSouth Data Center holidays are excluded. BellSouth and MCIm shall exchange schedules of designated Data Center holidays.

#### 4.2.2 Supporting Billing Information

##### 4.2.2.1 Returned Long Distance Messages and Invoices

4.2.2.1.1 EC shall return message records or invoices to MCI for messages or invoices which cannot be billed to a BellSouth end user because BellSouth no longer serves the end user for the associated messages or invoices as a result of the end user telephone number being served by another LEC/CLEC. BellSouth will return IC messages as misdirected if BellSouth no longer serves the end user.

4.2.2.1.2 Message records or invoices shall be returned as part of the established unbillable process. Returned messages or invoices shall be in industry-

standard EMR format using the OBF-agreed return code 50, unless otherwise negotiated with MCI.

4.2.2.1.3 Additional return codes to be used for return designations are as follows:

- 81 - Rated record is received and indicator 19 is set to a value of other than 1 or 3 for a CIC of zeroes.
- 82 - Message is determined to be interLATA, and interLATA is not determined to be applicable.
- 83 - field is designated as numeric field contains non-numeric values.
- 84 - message is terminating to number that has a NPA 900

4.2.2.1.4 The above message and/or invoice returns shall contain the Operating Company Number (OCN), or another identifying number or code as may become a future industry standard, of the LEC serving the end user through resale or portability at the time the invoice or message is returned:

4.2.2.1.5 Following are the record types and positions where the OCN should be populated. The error or return code should continue to appear in the standard position.

01-XX-XX record:	positions 168-171
01-51-21 record:	positions 125-128
01-51-24 record:	positions 187-190
41-XX-XX record (detail):	positions 168-171
41-50-XX record (summary):	positions 154-157
42-50-XX record (summary):	positions 154-157

4.2.2.2 Interim Number Portability. BellSouth shall provide MCI m call detail records identifying each IXC which are sufficient to allow MCI m to render bills to IXCs for calls IXCs place to ported numbers in the BellSouth network which the BellSouth forwards to MCI m for termination.

MCI m shall become the Customer of Record for the original BellSouth's telephone number(s), subject to the CALNP arrangements. BellSouth shall provide to MCI m the Electronic Message Records ("EMR") for all calls in a daily

electronic Network Data Mover ("NDM") feed or magnetic tape, as specified by MCI, for MCI customers.

#### 4.2.3 Product/Service Specific

4.2.3.2 BellSouth shall provide a Specialized Service / Service Provider Charge record to support the Special Features Star Services if these features are part of BellSouth's offering.

#### 4.2.4 Emergency Information

4.2.4.2 MCI shall arrange transport facilities per BellSouth tariffed services. BellSouth shall transmit via NDM whenever possible. In the event usage transfer cannot be accommodated by NDM because of extended (one (1) business day or longer) facility outages, BellSouth shall contract for a courier service to transport the data via tape. The data tape will be transported via courier service and costs for delivery will be borne by the company responsible for the outage.

4.2.4.3 BellSouth shall comply with the following standards when emergency data is transported to MCI on tape or cartridge via a courier. The data shall be in fixed or variable block format as specified by MCI and:

Tape: 9-track, 6250 (or 1600) BPI (Bytes per inch)

Cartridge: 38,000 BPI (Bytes per inch)

LRECL: 2,472 Bytes

Parity: Odd

Character Set: Extended Binary Coded Decimal Interchange Code (EBCDIC)

External labels: Exchange Carrier Name, Dataset Name (DSN) and volume serial number

Internal labels: IBM Industry OS labels shall be used. They consist of a single volume label and two sets of header and trailer labels.

#### 4.2.5 Rejected Recorded Usage Data

4.2.5.1 If MCI should encounter significant volumes of errored messages that prevent processing by MCI within its systems, BellSouth will work with MCI to jointly determine the source and appropriate error resolution.

4.2.5.2 BellSouth must return EMR/EMI records to IXCs with the OBF standard message reject code which indicates that BellSouth no longer serves the end user and which includes the OCN/Local Service Provider ID of the new LEC/Reseller serving the end user.

4.2.5.3 Rejected messages or invoices shall be returned to MCIm in accordance with procedures and timeframes already established between BellSouth and MCIm.

#### 4.2.6 Interfaces

4.2.6.1 BellSouth shall transmit formatted Recorded Usage Data to MCIm via NDM as designated by MCIm.

4.2.6.2 MCIm shall notify BellSouth of resend requirements if a pack or entire dataset must be replaced due to pack rejection, damage in transit, dataset name failure, etc.

4.2.6.3 Critical edit failure on the Pack Header or Pack Trailer records shall result in pack rejection (e.g., detail record count not equal to grand total included in the pack trailer). Notification of pack rejection shall be made by MCIm within one (1) business day of processing. Rejected packs shall be corrected by BellSouth and retransmitted to MCIm within twenty-four (24) hours or within an alternate timeframe negotiated on a case by case basis.

4.2.6.4 A pack shall contain a minimum of one message record or a maximum of 9,999 message records plus a pack header record and a pack trailer record. A file transmission contains a maximum of 99 packs. A dataset shall contain a minimum of one pack. BellSouth shall provide MCIm one dataset per sending location, with the agreed upon RAO/OCN populated in the Header and Trailer records.

#### 4.2.7 Formats & Characteristics

4.2.7.1 Rated in collect messages should be transmitted via the NDM and can be intermingled with the unrated messages. No special packing is needed

4.2.7.2 EMR: BellSouth shall provide Recorded Usage Data in the EMR format and by category, group and record type,

and shall be transmitted, via a direct feed, to MCIm. The following is a list of EMR records that MCIm can expect to receive from BellSouth:

Header Record	20-20-01
Trailer Record	20-20-02
Detail Records *	01-01-01, 06, 07, 08, 09, 16, 18, 31, 32, 33, 35, 37, 80, 81, 82, 83 10-01-01, 06, 07, 08, 09, 16, 18, 31, 32, 35, 37, 80, 81, 82, 83
Credit Records	03-01-01, 06, 08, 09, 14, 17, 18, 31, 32, 35, 37, 80, 81, 82,
Rated Credits	41-01-01, 06, 08, 09, 14, 17, 18, 31, 32, 35, 37, 80, 81, 82,
Cancel Records	51-01-01, 06, 08, 09, 14, 17, 18, 31, 32, 35, 37, 80, 81, 82, (58 -01 -xx where the record being canceled is unrated)
Correction Records	71-01-01, 06, 08, 09, 14, 17, 18, 31, 32, 35, 37, 80, 81, 82,

\* Category 01 is utilized for Rated Messages; Category 10 is utilized for Unrated Messages. Category 10 records are to have indicator 13 populated with a value of 5

In addition, BellSouth shall provide a 42-50-01 Miscellaneous Charge record to support the Special Features Star Services if these features are part of BellSouth's offering.

4.2.7.3 BellSouth shall comply with the most current version of Bellcore standard practice guidelines for formatting EMR records.

4.2.7.4 The Interfacing Bell RAO, OCN, and Remote Identifiers shall be used by MCIm to control invoice sequencing and each shall have its own invoice controls.

4.2.7.5 The file's Record Format (RECFM) shall be Variable Block with 175 character EMR record, plus modules if appropriate.

4.2.7.6 Initially, BellSouth may elect not to comply with specific sorting requirements. However, MCIm may elect to require BellSouth to sort PACKS in accordance with MCIm specifications at a later date.

4.2.7.7 BellSouth shall transmit the usage to MCIIm using dataset naming conventions prescribed by MCIIm.

4.2.8 Controls

4.2.8.1 MCIIm shall test and certify the NDM interface to ensure the accurate receipt of Recorded Usage Data.

4.2.8.2 Header and trailer records shall be populated in positions 13-27 with the following information:

Position	
13-14	Invoice numbers (1-99)
15-16	Bell Co. ID number
17-19	Interfacing Bell RAO Code
20-23	MCIIm OCN - value 7229
24-27	Reseller OCN

The trailer grand total record count shall be populated with total records in pack (excluding header & trailer)

4.2.8.3 Control Reports: MCIIm accepts input data provided by BellSouth in EMR format in accordance with the requirements and specifications detailed in this Section 8 of the Attachment III. In order to ensure the overall integrity of the usage being transmitted from BellSouth to MCIIm, data transfer control reports shall be required. These reports shall be provided by MCIIm to BellSouth on a daily or otherwise negotiated basis and reflect the results of the processing for each pack transmitted by BellSouth.

4.2.8.4 Control Reports - Distribution: Since BellSouth is not receiving control reports, dataset names shall be established during detailed negotiations.

4.2.8.5 Message Validation Reports: MCIIm shall provide the following once(1) per day (or as otherwise negotiated) Message Validation reports to the designated BellSouth System Control Coordinator. These reports shall be provided for all data received within BellSouth Local Resale Feed and shall be transmitted Monday through Friday.



4.2.8.6 Incollect Pack Processing: This report provides vital statistics and control totals for packs rejected and accepted and dropped messages. The information is provided in the following report formats and control levels:

BellSouth Name  
Reseller Total Messages processed in a pack  
Packs processed shall reflect the number of  
messages initially erred and accepted within a pack  
Reseller Total Packs processed

4.2.8.7 MCIIm requires information on a subscriber's selection of billing method, special language billing, and other billing options.

#### 4.3 Standards

4.3.1 When requested by MCIIm for security purposes, BellSouth shall provide MCIIm with Recorded Usage Data as soon as practical. If not available in EMR format, the Recorded Usage Data may be provided in AMA format.

4.3.2 BellSouth shall include the Working Telephone Number (WTN) of the call originator on each EMR call record where Technically Feasible.

4.3.3 End user subscriber usage records and station level detail records shall be in packs in accordance with EMR standards.

4.3.4 BellSouth shall provide Recorded Usage Data to MCIIm on a schedule to be determined by the parties once a day Monday through Friday except holidays.

4.3.5 BellSouth shall segregate and organize the Recorded Usage Data in a manner mutually agreed upon between BellSouth and MCIIm..

#### 4.4 Performance Measurements

4.4.1 Account Maintenance. When notified by a CLEC that an MCIIm Customer has switched to CLEC service, BellSouth shall provision the change, and notify MCIIm that the customer has changed to another service provider ("OUTPLOC") within one (1) business day, 100% of the time.

**MCImetro - BellSouth Florida Interconnection Agreement**

4.4.1.1 When notified by MCI that a customer has changed his/her PIC only from one interexchange carrier to another carrier, BellSouth shall provision the PIC only change and convey the confirmation of the PIC change via the work order completion feed with 100% of the orders contained within one (1) business day.

4.4.1.2 If notified by an interexchange carrier using an '01' PIC order record that an MCI Customer has changed his/her PIC only, BellSouth will reject the order and notify that interexchange carrier that a CARE PIC record should be sent to the serving CLEC for processing. 100% of all orders shall be rejected, and the respective interexchange carrier properly notified, within one (1) business day of BellSouth's receipt of the PIC order from the interexchange carrier.

**4.4.2 File Transfer**

BellSouth will initiate and transmit all files error free and without loss of signal.

Metric:  
Number of FILES Received  

---

Number of FILES Sent X 100

Notes: All measurement will be made on a rolling period.

Measurement:  
Meets Expectations 6 months of file transfers without a failure

**4.4.3 Timeliness**

BellSouth will mechanically transmit, all usage records to MCI's Message Processing Center three (3) times a day.

Measurement:

Meets Expectations: 99.94% of all messages delivered on the day the call was Recorded.

**4.4.4 Completeness**

BellSouth will provide all required Recorded Usage Data and ensure that it is processed and transmitted within thirty (30) days of the message create date.

**Metric:**

Total number of Recorded Usage Data records delivered during current month  
minus Number of Usage Call Records held in error file at the end of the current  
month

$$\frac{\text{Total number of Recorded Usage Data records delivered during current month} - \text{Number of Usage Call Records held in error file at the end of the current month}}{\text{Total number of Recorded Usage Data Records delivered during current month}} \times 100$$

**Measurement:**

Criteria

**Meets Expectations**  $\geq 99.99\%$  of all records delivered

**4.4.5 Accuracy**

BellSouth will provide Recorded Usage Data in the format, and with the content as defined in the current BellCore EMR document.

**Metric:**

$$\frac{\text{Total Number of Recorded Usage Data Transmitted Correctly}}{\text{Total Number of Recorded Usage Data Transmitted}} \times 100$$

**Measurement:**

Criteria

**Meets Expectations**  $\geq 99.99\%$  of all recorded records delivered

**4.4.6 Data Packs**

BellSouth will transmit to MCI all packs error free in the agreed-upon format.

**Measurement:**

**Meets Expectations** 6 months of Transmitted Packs without a rejected pack

**Notes:** All measurements will be made on a Rolling Period.

**4.4.7 Recorded Usage Data Accuracy**

BellSouth will ensure that the Recorded Usage Data is transmitted to MCI error free. The level of detail includes, but is not limited to: detail required to Rating

the call, Duration of the call, and Correct Originating/Terminating information pertaining to the call. The error is reported to BellSouth as a Modification Request (MR). Performance is to be measured at two levels defined below. MCIIm will identify the priority of the MR at the time of hand-off as Severity 1 or Severity 2. The following are MCIIm expectations of BellSouth for each:

Measurement:

Severity 1:

Meets Expectations  $\geq 90\%$  of the MR fixed in  $\leq 24$  hours and 100% of the MR fixed in  $\leq 5$  days

Severity 2:

Meets Expectations  $\geq 90\%$  of the MR fixed in 3 Days and 100% of the MR fixed in  $\leq 10$  days

**4.4.8 Usage Inquiry Responsiveness.** BellSouth will respond to all usage inquiries within twenty-four (24) hours of MCIIm's request for information. It is MCIIm's expectation to receive continuous status reports until the request for information is satisfied.

**Measurements:**

**Rating**

**Meets Expectations** 100% of the Inquiries responded to within 24 hours.

**4.4.9** If MCIIm requests, in writing, a higher level of performance than BellSouth provides to its own subscribers, BellSouth shall inform MCIIm, in writing, of the amount MCIIm's desired performance level exceeds that which BellSouth provides to its subscribers as well as a reasonable estimate of what it would cost BellSouth to meet, measure, and report these standards. If MCIIm then communicates, in writing, to BellSouth that it desires such higher levels of performance, MCIIm shall pay BellSouth for the costs incurred in providing such higher level of service. Moreover, MCIIm shall pay all mechanisms necessary to capture and report data, required to measure, report or track any performance measurement that BellSouth does not, as of the Effective Date, measure, report or track for itself or its own subscribers. In the event such system is not developed exclusively for MCIIm, but rather is developed for use with other CLECs, as well as MCIIm,

## **MCImetro - BellSouth Florida Interconnection Agreement**

BellSouth shall allocate to MCIm, on a competitively neutral basis, MCIm's share of the costs associated with such system.

### **4.5 Reporting**

**4.5.1** BellSouth shall agree to develop reports to be used for local usage and for PIC change data performance measurement within (sixty) 60 days of the Effective Date of this Agreement.

### **4.5.2 Left Blank Intentionally**

#### **4.5.2.1 Left Blank Intentionally**

## **Section 5. Maintenance**

### **5.1 General Requirements**

For maintenance, the parties agree to implement the BellSouth approved EBI standard within 12 months of the signing of this Agreement. MCIm understands that within such 12 month period BellSouth may not be able to make full implementation of the approved EBI standard, and provided BellSouth uses its best efforts to fully implement such standard as soon as possible, MCI agrees to accept less than full implementation at the conclusion of the 12 month period. MCI further agrees to accept on an interim basis, until such time as EBI is implemented, the interfaces approved by BellSouth.

**5.1.1** BellSouth shall provide repair, maintenance, testing, and surveillance for all Telecommunications Services and unbundled Network Elements and Combinations in accordance with the terms and conditions of this Agreement.

**5.1.1.1** During the term of this Agreement, BellSouth shall provide necessary maintenance business process support as well as those technical and systems interfaces required to enable MCIm to provide at least the same level and quality of service for all services for resale, functions, features, capabilities and unbundled elements or combinations of elements as BellSouth provides itself, its subscribers any of its Affiliated or subsidiaries or any other entity. BellSouth shall provide MCIm with the same level of maintenance support as BellSouth provides itself in accordance with standards and performance measurements that are at least equal to the highest level of standards and/or performance measurements that BellSouth uses and/or which are

required by law, regulatory agency, or by BellSouth's own internal procedures, whichever are the most rigorous. These standards shall apply to the quality of the technology, equipment, facilities, processes, and techniques (including, but not limited to, such new architecture, equipment, facilities, and interfaces as BellSouth may deploy) that BellSouth provides to MCIm under this Agreement.

5.1.1.2 Until an Electronic Interface is available, BellSouth shall provide access numbers to the state specific TRC (Trouble Reporting Center) based on class of service for MCIm to report via telephone maintenance issues and trouble reports twenty-four (24) hours a day and seven (7) days a week.

5.1.1.3 BellSouth shall provide MCIm maintenance dispatch personnel on the same schedule that they provide their own subscribers.

5.1.2 MCIm shall handle all interaction with MCIm subscribers including all calls regarding service problems, establishing appointments pursuant to Section 5.1.11, and notifying the subscriber of trouble status and resolution, unless otherwise authorized by MCIm.

5.1.3 BellSouth shall cooperate with MCIm to meet maintenance standards set forth in this Attachment for all Telecommunications Services, unbundled network elements and Combinations ordered under this Agreement. Such maintenance standards shall include, without limitation, standards for testing, network management, call gapping, and notification of upgrades as they become available.

5.1.4 All BellSouth employees or contractors who perform repair service for MCIm subscribers shall follow at a minimum, procedures and protocols which ensure that: (1) BellSouth employees or contractors shall perform repair service that is at least equal in quality to that provided to BellSouth subscribers; (2) trouble calls from MCIm subscribers shall receive response time priority that is at least equal to that of BellSouth subscribers and shall be handled on a "first come first served" basis regardless of whether the subscriber is an MCIm subscriber or a BellSouth subscriber.

5.1.5 BellSouth shall provide MCIm with the same scheduled and non-scheduled maintenance including, without limitation, required and recommended maintenance intervals and procedures for all Local Services, Network Elements and Combinations provided to MCIm under this Agreement that it currently provides for maintenance of its own network. Procedures for scheduled and non-scheduled maintenance will be documented in the work center agreements.

BellSouth shall negotiate the release of any scheduled and non-scheduled maintenance for Unbundled Network Elements or Large Business Subscribers' service with MCIm prior to any activity which may impact those services.

For services provided through resale, the BellSouth agrees to provide scheduled maintenance for residence and small business subscribers, consisting of cable throws, performed with test sets which prevent the subscribers' services from being interrupted during the activity. BellSouth shall monitor individual cutover work to insure that the service is not in use prior to the cut. Central office conversions shall be publicized through the media and will occur after midnight and before 4:00 A.M., unless MCIm is provided with written notification.

For misdirected calls, BellSouth and MCIm shall advise customers to contact MCIm and BellSouth, respectively, and offer the customer the contact number upon request.

5.1.6 Left Blank Intentionally

5.1.7 Left Blank Intentionally

5.1.8 BellSouth shall inform MCIm of repair completion and trouble reason as soon as possible after restoration of network elements, or Combinations, and any other trouble reports by MCIm. Notification should be provided via electronic interface, when available.

5.1.9 BellSouth and MCIm shall mutually develop escalation procedures to be followed if, in MCIm's judgment, any performance standard defined in this Agreement is not met for any individual trouble report. The escalation procedures to be provided shall include telephone numbers of BellSouth management personnel

who are responsible for maintenance issues and who will be contacted when a trouble condition is escalated.

5.1.10 BellSouth and MCIm shall mutually develop procedures to establish the conditions under which a root cause analysis will be performed and the methods by which the results will be conveyed to MCIm.

5.1.11 Dispatching of BellSouth technicians to MCIm subscriber premises shall be accomplished by BellSouth pursuant to a request received from MCIm. MCIm shall be able to schedule appointment windows based on load. The electronic interface established pursuant to subsection 5.2 shall provide the capability of allowing MCIm to receive trouble reports, analyze and sectionalize the trouble, determine whether it is necessary to dispatch a service technician to the subscriber's premises, and verify by disposition codes or narratives any actual work completed on the subscriber's premises.

5.1.12 BellSouth shall supply MCIm with a unique number, which may be the customer's actual number, to identify each MCI initial trouble report opened. For repeat trouble reports, if the previous trouble was within a 30 day period, the report will be flagged as a repeat report automatically.

5.1.13 Left Blank Intentionally

5.1.14 All MCIm subscribers shall be able to continue to use the established local dialing protocol to access the repair center. Upon dialing "611", the subscriber shall be presented with a non-branded menu that requests the input of the subscriber's telephone number. Once the telephone number is provided, the subscriber shall be transferred to the MCIm repair center. Whenever the BellSouth receives a repair call directly from an MCIm subscriber, without voice response menu prompts, the call shall be unbranded and transferred to the appropriate MCIm repair center.

5.1.15 Until such information is available via an Electronic Interface, BellSouth will notify MCIm upon completion of trouble report. The report shall not be considered closed until such notification is made. MCIm will contact its subscriber to determine if repairs were completed and confirm the trouble no longer exists.



### 5.1.16 Additional Unbundling Requirements

5.1.16.1 When trouble is reported by a subscriber served through unbundled network elements, MCIm will test its network to identify any problems. If no problems are identified with the MCIm network, MCIm will open a trouble report with BellSouth. BellSouth shall then test its portion of the network and perform repairs as required in the timeframes set forth below in this Agreement.

5.1.16.1.1 MCIm will coordinate combined testing or repair activities until trouble is resolved. BellSouth shall provide repair updates to MCIm.

### 5.2 Systems Interfaces and Information Exchanges

5.2.1.1 For line based (POTS) Resold Local Service, BellSouth shall develop a real-time, on-line Electronic Interface for access by MCIm to BellSouth's maintenance systems and databases, in order to allow MCIm to: (i) receive "estimated time to repair" ("ETTR") on a real-time basis; (ii) based on the nature of the reported trouble, perform electronic test at time of entry and provide test results to MCIm; and (iii) provide final closure on trouble tickets entered into BellSouth maintenance system for an MCIm subscriber. This capability will be deployed by March 31, 1997.

In addition BellSouth agrees to continue to develop the electronic interface capability to provide MCIm with ability to: (iv) receive timely notification in the event a repair person is unable to be present for, or anticipates missing, a scheduled repair appointment; and (v) retrieve all applicable time and material charges at the time of ticket closure (itemized by time spent, price of materials used, procedures employed, amounts incurred in each such category, and total by customer, per event).

5.2.1.2 As an option to the above, MCIm may opt to use the existing Electronic Communications gateway interface for line based (POTS) Resold Local Service. This interface will allow MCIm maintenance personnel and customer services representatives to perform the following functions for MCIm subscribers: (i) enter a new trouble ticket into the BellSouth

**maintenance system for an MCI subscriber; (ii) limited ability to retrieve and track current status on all MCI subscriber repair tickets; and (iii) provide final closure on trouble tickets entered into BellSouth's maintenance system for an MCI subscriber.**

**For local services provisioned via the Access Service Request (ASR) process, the Electronic Communications gateway interface may be used.**

**5.2.2 BellSouth shall perform all testing for Resale Services.**

**5.2.2.1 Until the electronic interface with MCI is fully operational, BellSouth shall provide test results to MCI, if appropriate, for trouble clearance. When the electronic interface with MCI is fully operational, BellSouth shall give MCI the ability to retrieve such results via the electronic interface. In all instances, BellSouth will provide MCI with the disposition of the trouble.**

**5.2.2.2 If BellSouth initiates trouble handling procedures it will bear all costs associated with that activity. If MCI requests the trouble dispatch then MCI will bear the cost.**

**5.2.3 Until such information is available via the Electronic Interface, BellSouth shall provide to MCI the ability to obtain the status on open maintenance trouble reports via telephone or by another interface as the parties may mutually agree. BellSouth agrees to provide the status of residence and small business trouble reports upon MCI's request.**

**5.2.4 BellSouth agrees to provide to MCI the status for open maintenance trouble reports for large business subscribers anytime the status of the trouble report changes or at MCI's request.**

**5.2.5 Until the electronic interface with MCI is fully operational, BellSouth agrees that MCI may call BellSouth to verify central office features and functions as they relate to an open trouble report. BellSouth agrees to work with MCI on the initial trouble report to isolate the cause of the trouble and, where possible, resolve the feature/function related trouble at that time.**

5.2.6 BellSouth agrees to advise MCI of any central office failure that is known at the time of any inquiry or trouble report. BellSouth agrees to continue to use its best efforts to implement a process which will provide automatic notification to MCI at the time of trouble ticket entry.

5.2.7 BellSouth agrees to provide an Estimated Time To Repair (ETTR), an appointment time or commitment time, as appropriate, on all residence and small business trouble reports.

5.2.8 BellSouth agrees to develop, with MCI's cooperation, mutually acceptable workcenter interface agreements to document methods and procedures for interim and final interfaces for each service within sixty (60) days following the effective date of this Agreement or MCI's notice to BellSouth of its initiation of that service. The sixty (60) day period shall be extended to the extent of any delay attributable to MCI.

### 5.3 Procedures

5.3.1 Maintenance charges for premises visits by BellSouth employees or contractors shall be billed to MCI and not to the subscriber.

5.3.1.1 If additional work is required, BellSouth employees or contractors shall call MCI from subscriber premises so that MCI can schedule a new appointment with BellSouth and subscriber at the same time.

5.3.1.2 BellSouth employees or contractors shall present the subscriber with an unbranded form, or MCI provided MCI branded form, detailing the time spent, the materials used and an indication that the trouble has either been resolved, or that additional work will be necessary.

5.3.1.3 The BellSouth employees or contractors shall use its best efforts obtain the subscriber's signature upon said form, and use the signed form to input maintenance charges into the BellSouth repair and maintenance database (accessible by way of electronic interface). These charges shall include any charges for inside wiring work by BellSouth employees or contractors.

### 5.4 Performance Measurements and Reporting

5.4.1 Where an outage has not reached the threshold defining an emergency network outage, the following quality standards shall apply with respect to restoration of Local Service and Network Elements or Combination. Total outages requiring a premises visit by a BellSouth technician that are received between 8 a.m. to 6 p.m. on any business day shall be restored within four (4) hours of referral, ninety percent (90%) of the time.

Total outages requiring a premises visit by a BellSouth technician that are received between 6 p.m. and 8 a.m. on any day shall be restored during the following 8 a.m. to 6 p.m. period in accordance with the following performance metric: within four (4) hours of 8 a.m., ninety percent (90%) of the time. Total outages which do not require a premises visit by a BellSouth technician shall be restored within two (2) hours of referral, eighty-five percent (85%) of the time.

5.4.2 Trouble calls (e.g., related to Local Service or Network Element or Combination degradation or feature problems) which have not resulted in total service outage shall be resolved within twenty-four (24) hours of referral, ninety-five percent (95%) of the time, irrespective of whether or not resolution requires a premises visit. For purposes of this Section, Local Service or a Network Element or Combination is considered restored, or a trouble resolved, when the quality of the Local Service or Network Element or Combination is equal to that provided before the outage, or the trouble, occurred.

5.4.3 The BellSouth repair bureau shall provide to MCI/m the "estimated time to restore" with at least ninety-seven percent (97%) accuracy.

5.4.4 Repeat trouble reports from the same customer in a 30 days period shall be less than one percent (1%). Repeat trouble reports shall be measured by the number of calls received by the BellSouth repair bureau relating to the same telephone line during the current and previous report months.

5.4.5 BellSouth shall inform MCI/m within ten (10) minutes of restoration of Local Service, Network Element, or Combination after an outage has occurred.

5.4.6 If service is provided to MCI/m Subscribers before an Electronic Interface is established between MCI/m and BellSouth,

MCIm will transmit repair calls to the BellSouth repair bureau by telephone. In such event, the following standards shall apply: The BellSouth repair bureau shall answer its telephone and begin taking information from MCIm within twenty (20) seconds of the first ring, ninety-five percent (95%) of the time. Calls answered by automated response systems, and calls placed on hold, shall be considered not to meet these standards.

5.4.7 BellSouth will miss meeting end user appointments that require a premise visit less than 1% of the time.

5.4.8 If MCIm requests, in writing, a higher level of performance than BellSouth provides to its own subscribers, BellSouth shall inform MCIm, in writing, of the amount MCIm's desired performance level exceeds that which BellSouth provides to its subscribers as well as a reasonable estimate of what it would cost BellSouth to meet, measure, and report these standards. If MCIm then communicates, in writing, to BellSouth that it desires such higher levels of performance, MCIm shall pay BellSouth for the costs incurred in providing such higher level of service. Moreover, MCIm shall pay all mechanisms necessary to capture and report data, required to measure, report or track any performance measurement that BellSouth does not, as of the Effective Date, measure, report or track for itself or its own subscribers. In the event such system is not developed exclusively for MCIm, but rather is developed for use with other CLECs, as well as MCIm, BellSouth shall allocate to MCIm, on a competitively neutral basis, MCIm's share of the costs associated with such system.

## **Section 6. Miscellaneous Services & Functions**

### **6.1 General Requirements**

#### **6.1.1 Basic 911 and E911 General Requirements**

6.1.1.1 Basic 911 and E911 provides a caller access to the appropriate emergency service bureau by dialing a 3-digit universal telephone number (911). Basic 911 and E911 access from Local Switching shall be provided to MCIm in accordance with the following:

6.1.1.2 E911 shall provide additional routing flexibility for 911 calls. E911 shall use subscriber data, contained in the Automatic Location Identification/ Data Management System (ALI/DMS) and the E911 tandem switch, to determine to

which Public Safety Answering Point (PSAP) to route the call.

6.1.1.3 If available, BellSouth shall offer a third type of 911 service, S911. All requirements for E911 also apply to S911 with the exception of the type of signaling used on the interconnection trunks from the local switch to the S911 tandem.

6.1.1.4 Basic 911 and E911 functions provided to MCIm shall be at least at parity with the support and services that BellSouth provides to its subscribers for such similar functionality.

6.1.1.5 Basic 911 and E911 access from Local Switching shall be provided to MCIm in accordance with the following:

6.1.1.5.1 BellSouth shall conform to all state regulations concerning emergency services.

6.1.1.5.2 For E911, BellSouth shall receive data from MCIm as described in the MCIm GUIDE (electronically via FTS). Errors will be mechanically faxed to MCIm promptly after the errors are detected by the update process. MCIm will transmit daily update files for "batch" processing within 24 hours of receipt of a "good file."

6.1.1.6 BellSouth shall provide for overflow 911 traffic to be routed to BellSouth Operator Services or, at MCIm's discretion, directly to MCIm operator services or to a seven digit number as provided by BellSouth and/or the appropriate public safety agency.

6.1.1.7 Basic 911 and E911 access from the MCIm local switch shall be provided to MCIm in accordance with the following:

6.1.1.7.1 Subject to mutual agreement, BellSouth shall interconnect direct trunks from the MCIm network to the E911 PSAP, or the E911 tandems as designated by MCIm. Such trunks may alternatively be provided by MCIm, without the selective routing function.

6.1.1.7.2 In government jurisdictions where BellSouth has obligations under existing Agreements as the primary provider of the 911 System to the county, MCI shall participate in the provision of the 911 System as follows:

6.1.1.7.2.1 Each party shall be responsible for those network portions of the 911 System for which it has control, including any necessary maintenance to each party's portion of the 911 System.

6.1.1.7.2.2 Host BellSouth shall be responsible for maintaining the E-911 database BellSouth including validating MCI updates against MSAG and posting valid updates to E911 database. Errors will be returned to MCI for correction and transmission of valid updates.

6.1.1.7.3 If a third party is the primary service provider to a government agency, MCI shall negotiate separately with such third party with regard to the provision of 911 service to the agency. All relations between such third party and MCI are totally separate from this Agreement and BellSouth makes no representations on behalf of the third party.

6.1.1.7.4 If MCI or Affiliate is the primary service provider to a government agency, MCI and BellSouth shall negotiate the specific provisions necessary for providing 911 service to the agency and shall include such provisions in an amendment to this Agreement.

6.1.1.7.5 Interconnection and database access shall be priced as specified in Attachment I or at any rate charged to other interconnected carriers, whichever is lower.

6.1.1.7.6 BellSouth shall comply with established, competitively neutral intervals for installation of facilities, including any collocation facilities, diversity requirements, etc.

6.1.1.7.7 Where it may be appropriate for BellSouth to update the ALI database, BellSouth shall update such database with MCIm data in an interval no less than is experienced by BellSouth subscribers, or than for other carriers, whichever is faster, at no additional cost.

6.1.1.8 BellSouth shall provide to MCIm, where available, no later than fifteen (15) days after the Effective Date of this Agreement, the emergency public agency (e.g. police, fire, rescue, poison, and bomb) telephone numbers linked to all NPA NXXs for the states in which they provide service. Such information shall be used solely for purposes of handling emergency calls.

6.1.1.9 BellSouth shall transmit to MCIm all changes, alterations, modifications, and updates to the emergency public agency telephone numbers linked to all NPA NXX's when known.

6.1.1.10 The following are Basic 911 and E911 Database Requirements:

6.1.1.10.1 The TN data is managed in ALI by BellSouth, but the responsibility for providing the data resides with each Local Service Provider.

6.1.1.10.2 Copies of the MSAG shall be provided within seven (7) business days from the time requested and provided on magnetic tape or paper.

6.1.1.10.3 MCIm shall be solely responsible for providing MCIm database records to BellSouth for inclusion in BellSouth's ALI database on a timely basis.

6.1.1.10.4 BellSouth and MCIm shall arrange for the automated input and periodic updating of the E911 database information related to MCIm end users as stated in the ALEC Guide (Local Exchange Users Guide for Facility Based Providers). BellSouth shall work cooperatively with MCIm to ensure the accuracy of the data transfer by verifying it against the Master Street Address Guide (MSAG). BellSouth



**MCImetro - BellSouth Florida Interconnection Agreement**

**6.1.1.10.5** MCIm shall assign an E911 database coordinator charged with the responsibility of forwarding MCIm end user ALI record information to BellSouth or via a third-party entity, charged with the responsibility of ALI record transfer. MCIm assumes all responsibility for the accuracy of the data that MCIm provides to BellSouth.

**6.1.1.10.6** MCIm shall provide information on new subscribers to BellSouth within one (1) business day of the order completion. BellSouth shall update the database within two (2) business days of receiving the data from MCIm. If BellSouth detects an error in the MCIm provided data, the data shall be returned to MCIm within two (2) business days from when it was provided to BellSouth. MCIm shall respond to requests from BellSouth to make corrections to database record errors by uploading corrected records within two (2) business days.

**6.1.1.10.7** BellSouth agrees to treat all data on MCIm subscribers provided under this Agreement as strictly confidential and to use data on MCIm subscribers only for the purpose of providing E911 services.

**6.1.1.10.8** BellSouth shall adopt use of a Carrier Code (NENA standard five-character field) on all ALI records received from MCIm at such time as a NENA standard carrier codes is implemented. The Carrier Code will be used to identify the carrier of record in INP configurations.

**6.1.1.10.9** BellSouth shall identify which ALI databases cover which states, counties or parts thereof, and identify and communicate a Point of Contact for each.

**6.1.1.11** Left blank intentionally

**6.1.1.12** The following are basic 911 and E911 Network Requirements:

**6.1.1.12.1** BellSouth, at MCIm's option, shall provide a minimum of two (2) E911 trunks per Numbering Plan Area (NPA) code, or that quantity which will

maintain parity with the BellSouth's grade of service, whichever is the higher grade of service. These trunks will be dedicated to routing 911 calls from MCI's switch to a BellSouth selective router.

6.1.1.12.2 BellSouth shall provide the selective routing of E911 calls received from MCI's switching office where feasible. This includes the ability to receive the ANI of MCI's subscriber, selectively route the call to the appropriate PSAP, and forward the subscriber's ANI to the PSAP. BellSouth shall provide MCI with the appropriate CLLI codes and specifications regarding the tandem serving area associated addresses and meetpoints in the network.

6.1.1.12.3 Selective Routing Boundary documentation shall be available to MCI. Documentation shows the boundary around the outside of the set of exchange areas served by that selective router. The documentation provides MCI the information necessary to set up its network to route E911 callers to the correct selective router.

6.1.1.12.4 MCI shall ensure that its switch provides an eight-digit ANI consisting of an information digit and the seven-digit exchange code. MCI shall also ensure that its switch provides the line number of the calling station. Where applicable and mutually agreed to, MCI shall send a ten-digit ANI to BellSouth.

6.1.1.12.5 Each ALI discrepancy report shall be transmitted by BellSouth to MCI for corrective action.

6.1.1.12.6 The BellSouth controlling the 911 network should provide MCI with a detailed written description of the following information on a one time basis:

6.1.1.12.6.1 When requested by MCI, geographic boundaries of the BellSouth exchange service areas, and assistance in identifying the geographic boundaries of the

government entities and PSAPs, as necessary.

6.1.1.12.6.2 When requested by MCIm, LECs rate centers/exchanges, where "Rate Center" is defined as a geographically specified area used for determining mileage dependent rates in the Public Switched Telephone Network.

6.1.1.12.6.3 Technical specifications for network interface, Technical specifications for database loading and maintenance.

6.1.1.12.7 Left blank intentionally

6.1.1.12.8 BellSouth shall begin restoration of E911 and/or E911 trunking facilities immediately upon notification of failure or outage. BellSouth must provide priority restoration of trunks or networks outages on the same terms/conditions it provides itself and without the imposition of Telecommunications Service Priority (TSP).

6.1.1.12.9 Left Blank intentionally

6.1.1.12.10 Left blank intentionally

6.1.1.12.11 Diversity will be maintained or upgraded to utilize the highest level of diversity available in the network.

6.1.1.12.12 Equipment and circuits used for 911 shall be monitored at all times. Monitoring of circuits shall be done to the individual circuit level. Monitoring shall be conducted by BellSouth for trunks between the tandem and all associated PSAPs.

6.1.1.12.13 Repair service shall begin immediately upon receipt of a report of a malfunction. Repair service includes testing and diagnostic service from a remote location, dispatch of or in-person visit(s) of personnel. Technicians will be dispatched without delay.

6.1.1.12.14 All 911 trunks must be capable of transmitting and received Baudot code necessary to support the use of Telecommunications Devices for the Deaf (TTY/TDDs).

**6.1.1.13 Basic 911 and E911 Additional Requirements**

6.1.1.13.1 All MCIm lines that have been ported via INP shall reach the correct PSAP when 911 is dialed. BellSouth shall send both the ported number and the MCIm number (if both are received from MCIm) to the PSAP.

6.1.1.13.2 BellSouth, where available, shall work with the appropriate government agency to provide MCIm the ten-digit POTS number of each PSAP which subtends each BellSouth selective router/911 tandem to which MCIm is interconnected.

6.1.1.13.3 BellSouth shall notify MCIm 48 hours in advance of any scheduled testing or maintenance affecting MCIm 911 service, and provide notification as soon as possible of any unscheduled outage affecting MCIm 911 service.

6.1.1.13.4 MCIm shall be responsible for reporting all errors, defects and malfunctions to BellSouth. BellSouth shall use its best efforts to provide MCIm with the point of contact for reporting errors, defects, and malfunctions in the service and shall also provide escalation contacts within thirty (30) days of the Effective Date.

6.1.1.13.5 MCIm may enter into subcontracts with third parties, including MCIm Affiliates, for the performance of any of MCIm's duties and obligations stated herein.

6.1.1.13.6 BellSouth Within ninety (90) days of a BellSouth decision to implement SS7 signaling, BellSouth shall notify MCIm of such decision...

6.1.1.13.7 BellSouth shall provide notification of any pending tandem moves, NPA splits, or scheduled maintenance outages, with enough time to react.

6.1.1.13.8 BellSouth shall notify MCIm within 30 days of BellSouth's decision to implement "reverse ALI" inquiries by public safety entities.

6.1.1.13.9 BellSouth shall continue its existing process for the management of NPA splits by populating the ALI database with the appropriate new NPA codes.

6.1.1.13.10 BellSouth must provide the ability for MCIm to update 911 database with end user information for lines that have been ported via INP or NP.

6.1.1.13.11 MCIm may, at its discretion, further request additional and/or modified reporting as business needs demand.

#### 6.1.2 Directory Assistance Service

6.1.2.1 BellSouth shall provide for the routing of directory assistance calls (including but not limited to 411, 555-1212, NPA-555-1212) dialed by MCIm subscribers directly to either the MCIm DA service platform or BellSouth DA service platform as specified by MCIm. BellSouth shall provide MCIm with selective routing via Line Class Codes on a first-come, first-served basis. BellSouth may reserve for itself a reasonable number of line class codes. Further, MCIm and BellSouth shall continue to work with the appropriate industry groups to develop a long term solution for selective routing.

6.1.2.2 MCIm subscribers shall be provided the capability by BellSouth to dial the same telephone numbers for access to MCIm Directory Assistance that BellSouth subscribers to access BellSouth Directory Assistance.

6.1.2.3 BellSouth shall provide Directory Assistance functions and services to MCIm for its subscribers as described below until, at MCIm's discretion, BellSouth routes calls to the MCIm Directory Assistance Services platform.

6.1.2.3.1 BellSouth agrees to provide MCIm subscribers with the same Directory Assistance service available to BellSouth subscribers.

6.1.2.3.2 BellSouth shall notify MCIm in advance of any changes or enhancements to its DA service, and shall make available such service enhancements on a non-discriminatory basis to MCIm.

6.1.2.3.3 BellSouth shall provide Directory Assistance to MCIm subscribers in accordance with BellSouth's internal operating BellSouth procedures and standards, which shall, at a minimum, comply with accepted professional and industry standards.

6.1.2.3.4 BellSouth shall provide MCIm with the same level of support for the provisioning of Directory Assistance as BellSouth provides itself. Quality of service standards shall be in accordance with standards and performance measurements that are at least equal to the highest level of standards and/or performance measurements that BellSouth uses and/or which are required by law, regulatory agency, or by BellSouth's own internal procedures, whichever are the most rigorous.

6.1.2.3.5 Service levels shall comply, at a minimum, with State Regulatory Commission requirements for number of rings to answer, average work time, and disaster recovery options.

6.1.2.3.6 BellSouth agrees to maintain an adequate operator work force based on service standards described in sections 6.1.2.3.4 and 6.1.2.3.5

6.1.2.3.7 Left blank intentionally

6.1.2.3.8 Directory Assistance services provided by BellSouth to MCIm subscribers shall be branded as required by MCIm. Branding includes front-end, back-end, and non-branding to be determined by MCIm.

6.1.2.3.9 BellSouth shall provide the following minimum Directory Assistance capabilities to MCIm's subscribers:

6.1.2.3.9.1 A minimum of two subscriber listings and/or addresses or BellSouth parity per MCIm subscriber request.

6.1.2.3.9.2 Name and address to MCIm subscribers upon request, except for unlisted numbers, in the same states where such information is provided to BellSouth subscribers.

6.1.2.3.9.3 Upon request, call completion to the requested number for local and intraLATA toll calls shall be sent to the network specified by MCIm. Rating and billing shall be done by MCIm.

6.1.2.3.9.4 Populate the Directory Assistance database in the same manner and in the same time frame as for BellSouth subscribers.

6.1.2.3.9.5 Any information provided by a Directory Assistance Automatic Response Unit (ARU) shall be repeated the same number of times for MCIm subscribers as for BellSouth's subscribers.

6.1.2.3.9.6 When requested by MCIm, BellSouth shall provide instant credit on directory assistance calls as provided to BellSouth subscribers. BellSouth

6.1.2.4 BellSouth shall provide data regarding billable events as mutually agreed upon by MCIm and BellSouth.

### 6.1.3 Operator Services

6.1.3.1 BellSouth shall provide for the routing of local operator services calls (including but not limited to 0+, 0-) dialed by MCIm subscribers directly to either the MCIm operator service platform or BellSouth operator service platform as specified by MCIm. BellSouth shall provide MCIm with selective routing via Line Class Codes on a first come-first served basis. BellSouth may reserve for itself a reasonable number of line class codes. Further, MCIm and BellSouth shall continue to work with the appropriate

industry groups to develop a long term solution for selective routing.

6.1.3.2 MCI subscribers shall be provided the capability by BellSouth to dial the same telephone numbers to access MCI operator service that BellSouth subscribers dial to access BellSouth operator service.

6.1.3.3 BellSouth shall provide Operator Services to as described below until, at MCI's discretion, BellSouth routes calls to the MCI Local Operator Services platform.

6.1.3.3.1 BellSouth agrees to provide MCI subscribers the same Operator Services available to BellSouth subscribers. BellSouth shall make available its service enhancements on a non-discriminatory basis.

6.1.3.3.2 Operator Services provided to MCI subscribers shall be branded as required by MCI. Branding options include front-end, back-end, and non-branding as specified by MCI.

6.1.3.3.3 BellSouth shall provide the following minimum Operator Service capabilities to MCI subscribers:

6.1.3.3.3.1 BellSouth shall complete 0+ and 0-dialed local calls.

6.1.3.3.3.2 BellSouth shall complete 0+ and 0-intraLATA toll calls.

6.1.3.3.3.3 BellSouth shall complete calls that are billed to a calling card and MCI shall designate to BellSouth the acceptable types of billing for Special Calling Cards (SCC's) or credit cards that can be accepted.

6.1.3.3.3.4 BellSouth shall complete person-to-person calls.

6.1.3.3.3.5 BellSouth shall complete collect calls.



**MCImetro - BellSouth Florida Interconnection Agreement**

**6.1.3.3.3.6 BellSouth shall provide the capability for callers to bill to a third party and complete such calls.**

**6.1.3.3.3.7 BellSouth shall complete station-to-station calls.**

**6.1.3.3.3.8 BellSouth shall process emergency calls when the caller dials 0- in error.**

**6.1.3.3.3.9 BellSouth shall process Busy Line Verify and Emergency Line Interrupt requests.**

**6.1.3.3.3.10 BellSouth shall process emergency call trace, subject to mutual agreement of MCIm and BellSouth on applicable processes.**

**6.1.3.3.3.11 BellSouth shall process operator-assisted directory assistance calls.**

**6.1.3.3.3.12 Upon a subscriber request for either a rate quote or time and charges, BellSouth shall, through a neutral response, inquire of the subscriber from which carrier the rate or time and charge is requested. The operator will transfer the call to that carrier.**

**6.1.3.3.3.13 Left blank intentionally**

**6.1.3.3.3.14 BellSouth shall route 0- traffic to a "live" operator team.**

**6.1.3.3.3.15 When requested by MCIm, BellSouth shall provide instant credit on operator services calls as provided to BellSouth subscribers.**

**6.1.3.3.3.16 Caller assistance for the disabled in the same manner as provided to BellSouth subscribers.**

**6.1.3.3.3.17 If and when available, BellSouth shall provide operator-assisted conference calling. BellSouth**

6.1.3.5 Operator Service shall adhere to equal access requirements when providing operator transfer services.

6.1.3.6 BellSouth shall exercise at least the same level of fraud control in providing Operator Service to MCIm that BellSouth provides for its own operator service.

6.1.3.7 BellSouth shall perform Billed Number Screening when handling Collect, Third Party, and Calling Card Calls, both for station to station and person to person call types.

6.1.3.8 BellSouth shall provide service measurements and accounting reports as mutually agreed by MCIm and BellSouth.

6.1.3.10 BellSouth shall direct subscriber account and other similar inquiries to the subscriber service center designated by MCIm, if requested by the subscriber.

6.1.3.11 BellSouth shall provide an electronic feed of subscriber call records in "EMR" format to MCIm in accordance with Section 4 of this Attachment.

6.1.3.13 Busy Line Verification and Emergency Line Interrupt:

6.1.3.13.1 BellSouth shall engineer its BLV/ELI facilities to accommodate the anticipated volume of BLV/ELI requests during the Busy Hour. MCIm may, from time to time, provide its anticipated volume of BLV/ELI requests to BellSouth. In those instances when the BLV/ELI systems and databases become unavailable, BellSouth shall promptly inform MCIm.

6.1.3.14 BellSouth shall update the Line Information Data Base (LIDB) for MCIm subscribers without charge. Additionally, BellSouth must provide access to LIDB for validation of collect, third party billed, and LEC card billed calls.

6.1.3.15 Where INP is deployed and when a BLV/BLI request for a ported number is directed to a BellSouth operator and the query is not successful (i.e., the request yields an abnormal result), the operator shall confirm

whether the number has been ported and shall direct the request to the appropriate operator.

6.1.3.15 BellSouth shall explore the technical feasibility of the following: Where INP is deployed and when a BLV/BL1 request for a ported number is directed to a BellSouth operator and the query is not successful (i.e., the request yields an abnormal result), the operator shall confirm whether the number has been ported and shall direct the request to the appropriate operator.

6.1.3.16 Charges for services provided pursuant to Section 6.1.3 shall be as set forth in Attachment I.

#### 6.1.4 Directory Assistance and Listings Service Requests

6.1.4.1 These requirements pertain to BellSouth's DA and Listings Service Request process that enables MCIm to (a) submit MCIm subscriber information for inclusion in BellSouth Directory Assistance and Directory Listings databases; (b) submit MCIm subscriber information for inclusion in published directories; and (c) provide MCIm subscriber delivery address information to enable BellSouth to fulfill directory distribution obligations.

6.1.4.1.1 BellSouth shall accept orders via electronic interface in accordance with approved TCIF EDI technical mapping within nine (9) months of published release of that approved standard. In the interim, BellSouth shall create a standard format for electronic exchange by which MCIm can place directory listing orders for resold single line residence and resold simple business, six lines or less, by April 1, 1997. BellSouth shall provide electronic exchange for directory listing orders associated with interim number portability, unbundled loops and unbundled ports no later than April 1, 1997

6.1.4.1.2 BellSouth will provide to MCIm the following Directory Listing Migration Options, valid under all interconnection methods, including but not limited to, Resale, Unbundled Network Elements and Facilities-Based:

**MCImetro - BellSouth Florida Interconnection Agreement**

**6.1.4.1.2.1 Migrate with no Changes: Retain and transfer all white and transfer all yellow page listings for the subscriber in both DA and DL. Transfer ownership and billing for listings to MCIm.**

**6.1.4.1.2.2 Migrate with Additions: Retain and transfer all white and transfer all yellow page listings for the subscriber in both DA and DL. Incorporate the specified additional listings order. Transfer ownership and billing for the listings to MCIm.**

**6.1.4.1.2.3 Migrate with Deletions: Retain and transfer all white and transfer all yellow page listings for the subscriber in both DA and DL. Delete the specified listings from the listing order. Transfer ownership and billing for the listings to MCIm.**

**6.1.4.1.3 BellSouth shall enable MCIm to electronically transmit multi-line listing orders.**

**6.1.4.1.4 Left Blank Intentionally**

**6.1.4.1.5 Left Blank Intentionally**

**6.1.4.1.6 Left blank intentionally**

**6.1.4.1.7 Based on changes submitted by MCIm, BellSouth shall update and maintain directory assistance and directory listings data for MCIm subscribers who:**

**6.1.4.1.7.1 Disconnect Service**

**6.1.4.1.7.2 Change of Local Carrier**

**6.1.4.1.7.3 Install Service**

**6.1.4.1.7.4 Change any service which affects DA information**

**6.1.4.1.7.6 Are Non-Published, Non-Listed, or Listed**

6.1.4.1.8 BellSouth shall not charge for storage of MCIm subscriber information in the DA and DL systems.

6.1.4.1.9 MCIm shall not charge for storage of BellSouth subscriber information in the DA and DL systems.

6.1.5 Left blank intentionally

6.1.6 Directory Assistance Data

6.1.6.1 BellSouth shall provide to MCIm, to the extent authorized, the residential, business, and government subscriber records used by BellSouth to create and maintain its Directory Assistance Data Base, in a non-discriminatory manner. MCIm may combine this element with any other Network Element for the provision of any Telecommunications Service.

6.1.6.2 Upon request, BellSouth shall provide an initial load of subscriber records via electronic data transfer for ILECS, CLECs and independent Telcos included in their Directory Assistance Database, to the extent authorized. The NPAs included shall represent the entire BellSouth operating territory. The initial load shall reflect all data that is current as of one business day prior to the provision date.

6.1.6.3 BellSouth shall provide MCIm, to the extent authorized, a complete list of ILECs, CLECs, and independent Telcos that provided data contained in the database.

6.1.6.4 All directory assistance data shall be provided in the format as specified in "Directory Assistance Data Information Exchanges and Interfaces" below or in Bellcore standard F20 format.

6.1.6.5 On a daily basis, BellSouth shall provide updates (end user and mass) to the Listing Information via electronic data transfer. Updates shall be current as of one business day prior to the date provided to MCIm.

6.1.6.6 Left Blank Intentionally

6.1.6.7 DA data shall specify whether the subscriber is a residential, business, or government subscriber. Additionally, data must include all levels of indentation and all levels of information specified in "Directory Assistance Data Information Exchanges and Interfaces" below.

6.1.6.8 DA data shall be provided on the same terms and conditions that BellSouth provides to itself or other third parties, and at the same rates that BellSouth provides to other third parties.

6.1.6.9 BellSouth shall provide complete refresh of the DA data upon mutual agreement of BellSouth and MCI and subject to applicable charges pursuant to Attachment I.

6.1.6.10 MCI and BellSouth, upon mutual agreement, will designate a Technically Feasible point at which the data will be provided.

## 6.2 Systems Interfaces and Exchanges

### 6.2.1 Basic 911 and E911 Information Exchanges and Interfaces

6.2.1.1 BellSouth shall provide MCI a data link to the ALI/DMS database or permit MCI to provide its own data link to the ALI/DMS database. BellSouth shall provide error reports from the ALI/DMS database to MCI after MCI inputs information into the ALI/DMS database. Alternately, MCI may utilize BellSouth or a third party entity to enter through the service order process subscriber information into the database on a demand basis, and validate subscriber information on a demand basis.

6.2.1.2 BellSouth and MCI shall arrange for the automated input and periodic updating of the E911 database information related to MCI end users as stated in the ALEC Guide (Local Exchange Users Guide for Facility Based Providers). BellSouth shall work cooperatively with MCI to ensure the accuracy of the data transfer by verifying it against the Master Street Address Guide (MSAG).

6.2.1.3 The TN data is managed in ALI by the BellSouth, but the responsibility for providing the data resides with each Local Service Provider.

## 6.2.2 Directory Assistance Data Information Exchanges and Interfaces

### 6.2.2.1 Subscriber List Information

6.2.2.1.1 BellSouth shall provide to MCIm, when an industry standard is available, and upon request by MCIm, all published Subscriber List Information (including such information that resides in BellSouth's master subscriber system/accounts master file) via an electronic data transfer medium and in a format which is acceptable to MCIm, on the same terms and conditions and at the same rates that the BellSouth provides Subscriber List Information to itself or to other third parties. When industry standards are available, all changes to the Subscriber List Information shall be provided to MCIm on the same day as the change occurred through the electronic data transfer medium used to transmit the initial Subscriber List Information. Both the initial List and all subsequent Lists shall indicate for each subscriber whether the subscriber is classified as residence or business class of service.

6.2.2.2 This section addresses data format requirements and data inclusion requirements for directory assistance data information exchange between BellSouth and MCIm. BellSouth shall provide MCIm the following:

6.2.2.2.1 List of NPA-NXX's relating to the listing records being provided.

6.2.2.2.2 List of Directory Section names and their associated NPA-NXX's.

6.2.2.2.3 List of Community Names expected to be associated with each of the NPA-NXX's for which listing records shall be provided.

6.2.2.2.4 List of Independent Company names and their associated NPA-NXX's for which their listing

data shall be included in BellSouth's listing data.

6.2.2.2.5 List of Independent Company names and their associated NPA-NXXs for which their listing data is a part of BellSouth's directory database, but BellSouth is not to provide the listing data to MCIm under this request.

6.2.2.2.6 Listing volume totals by directory section, NPA, and state.

6.2.2.2.7 Average daily update volume by directory section, NPA, and state.

6.2.2.2.8 Identify any area wide or universal service numbers which may be listed. Identify the telephone number to be provided to callers outside the servicing area.

6.2.2.2.9 Identify any listing condition(s) unique to BellSouth's serving area which may require special handling in data processing in the directory. Indented Listings (Captions) should be identified and delivered handled as specified.

### 6.2.2.3 Considerations Relating to an Indented Listing (Caption) Set Requirements

6.2.2.3.1 Use of line numbers, or other methods, to ensure the integrity of the caption set and identify the sequence or placement of a listing record within the caption set. A sufficient range of numbers between listing records is required to allow for the expansion of the caption set. A method is also required to permit the caption header record to be identified, but each level of indent is not required to be recapped; placement of the indent is based on line number. This method does require stringent edits to ensure the integrity of the caption set.

6.2.2.3.2 Use of guideline or recapped data to identify previously established header and sub-header records for placement of data within the caption set. This permits flexibility to easily expand the caption set. This method also requires that, in



addition to the caption header record, each level of indent be recapped in order to properly build the caption set.

6.2.2.3.3 In order to maintain the integrity of caption replacement, with end-of-day cumulative effect, one OUT record must be sent to delete the entire caption set, followed by IN activity each listing record within the caption set.

6.2.2.3.4 MCIm requires listing instruction codes on the service order which indicate how the set is to appear in the published directory.

**6.2.2.4 Data Processing Requirements: BellSouth and MCIm shall mutually agree to standards on the following data processing requirements:**

6.2.2.4.1 Identify type of tape to be used in sending the test and initial load data. For example, reel or cartridge tape. Due to the size of an initial load, it would be generally expected to be on tape and the daily update activity via another media, such as NDM.

6.2.2.4.2 Identify tape or dataset label requirements.

6.2.2.4.3 Identify tracking information requirements. For example, use of header and trailer records for tracking date and time, cycle numbers, sending and receiving site codes, volume count for the given tape/dataset. It may also be helpful to have some filler fields for future use.

6.2.2.4.4 Identify dates MCIm should not expect to receive daily update activity.

6.2.2.4.5 Data should be received in uppercase. An asterisk (\*) should be used advise of the need to apply the reverse capitalization rule. However, if the provider determines to provide the listing data from a database that has already messaged the data and applied the capitalization rules, the asterisk may be omitted.

6.2.2.4.6 Identify information that shall enable MCIIm to identify listings within an indented list (caption) set. For example:

6.2.2.4.6.1 When a particular listing has been designated to be filed as the first listing for a given level (0-7) of indent - usually out of alpha sequence.

6.2.2.4.6.2 When an alternate call listing (e.g. If no answer) relates to multiple preceding listings of the same level.

6.2.2.4.7 Identify any other pertinent information needed to properly process the data.

#### 6.2.2.5 Listing Types

<b>LISTED</b>	The listing information is available for all directory requirements.
<b>NON-LISTED</b>	The listing information is available to all directory requirements, but the information does not appear in the published street directory.
<b>NON-PUBLISHED</b>	A directory service may confirm, by name and address, the presence of a listing, but the telephone number is not available. MCIIm may confirm the address, but is not permitted to receive the non-published telephone number. The listing information is not available in either the published directory or directory assistance.

#### 6.2.2.6 Listing Styles

<b><u>LISTING STYLE</u></b>	<b><u>DESCRIPTION</u></b>
<b>STRAIGHT LINE</b>	All listing information is formatted in a straight line. Data generally consists of Name, Address, Community, and Telephone Number. Additional data may consist of dialing instructions or other general information relating to the listing.

<b>INDENTED LISTING SET - STRAIGHT LINE UNDER (SLU)</b>	Two or more listing records relating to the same listed subscriber. The first is formatted as a straight line listing with the additional listing(s) indented one degree under the straight line listing.
<b>INDENTED LISTING SET - CAPTION SET</b>	Formatted with one listing header record and multiple indented listing records. See detailed description below.

**INDENTED LISTING (CAPTION) SET**

<b>HEADER RECORD</b>	Contains listed name; address and telephone number data fields are blank.
<b>SUB-HEADER RECORD/ LISTING</b>	May contain name data only, or may include address and telephone number data. Associated subordinate records may, or may not be present.
<b>INDENTED NAME LISTING</b>	Contains name data, may or may not have address data, and telephone number data.
<b>INDENTED ADDRESS LISTING</b>	Contains address and telephone number data; the name data text field is blank.
<b>LEVEL OF INDENT</b>	Header record is zero (0), sub-header and indented records range from 1 - 7.

6.2.2.7 Data Field Elements

Requirements for Initial Processing and Daily Update Activity

DATA FIELD

<u>DATA FIELD</u>	<u>DATA ELEMENT</u>	<u>FIELD LENGTH</u>
ACTION CODE	A ' Add            I ' In D ' Delete    or    O ' out	Required: 1 alpha character
RECORD NUMBER	Sequentially assigned number to each record for a given process (test, initial load, or update activity). Number assignment begins with 00000001 and is incremented by 1 for each record on the file.	Required: 8 digits
NPA	Area code relating to the directory section the record is to be listed.	Required: 3 digits
COMPANY IDENTIFIER	The 4-character company code as defined in Section 8 of the National Exchange Carrier Association, Inc. Tariff.	Required: 4 digits
DIRECTORY SECTION LISTING IDENTIFIER	Name of the directory section where the record is to be listed. F ' Foreign C ' Cross-Reference E ' Enterprise (WX number requiring operator assistance to connect the call) W ' Wide area or universal service	Required: Maximum of 50 alpha characters Optional: 1 alpha character
FILE PLACEMENT	B ' Business (4) R ' Residence (1) G ' Government (2) BR ' Business & Residence (5) BG ' Business & Government (6) BRG ' Business, Residence, & Government (7)	Required: Maximum of 3 alpha characters
LISTING TYPE	L ' Listed	Required: Maximum of 2

MCImetro - BellSouth Florida Interconnection Agreement

	N ' Non-Listed NP ' Non-Published	alpha characters
LISTING STYLE	S ' Straight line I ' Indented listing set	Required: 1 alpha character
	An Indented listing relates to either a caption or Straight Line Under (SLU) set listing.	
INDENT LEVEL	0 ' Non-indented record 1 - 8 ' Level of indented record	Required: 1 digit
ADDRESS HOUSE NUMBER	For example: 123, A-123, 123-1/2	Optional: Maximum of 20 alphanumeric characters, including hyphen, space, and slash
ADDRESS PRE-DIRECTIONAL	For example: N, S, E, W, NE, SW, NORTH	Optional: Maximum of 5 alpha characters
ADDRESS STREET NAME	For example: Main, Peachtree-Dunwoody, HWY 75 at Exit 30	Optional: Maximum of 100 alpha, alphanumeric characters, including spaces and hyphens.
ADDRESS SUFFIX OR THOROUGHFARE	For example: SUITE 160, ST, or WAY	Optional: Maximum of 20 numeric, alpha, or alphanumeric characters
ADDRESS POST DIRECTION	For example: N, S, NE, SW	Optional: Maximum of 5 alpha characters
ADDRESS ZIP CODE	5-digits or ZIP + 4	Optional: Maximum of 10 digits, including the hyphen when using ZIP + 4
COMMUNITY NAME	Identifies the name of the community associated with the listing record. See Glossary for more details.	Maximum of 50 alphanumeric characters, including spaces and hyphen

MCImetro - BellSouth Florida Interconnection Agreement

STATE NAME ABBREVIATION	Identifies the state associated with the community name; 2-character state abbreviation used by the US Postal Office.	Maximum of 2 alpha characters
INFORMATION TEXT	Miscellaneous information relating to the listing. Including, but not limited to, for example: TOLL FREE DIAL 1 & THEN, CALL COLLECT, or TDD ONLY. The various types of Information Text must be identified to MCIm.	Optional: Maximum of 250 alpha, numeric, or alphanumeric characters
NAME - FIRST WORD	Surname of a Residence or Business listing, or first word of a Business or Government listing  Multi-word or hyphenated surnames should be treated as one word.	Required for a zero (0) level record. Optional if an indented (level 1-8) record, unless the name text present in the indented record relates to a Surname.
NAME - SUBSEQUENT WORD(S)	Given name and/or initial(s) of a Surname listing or Additional word(s) for a Business or Government listing	Maximum of 50 alpha, numeric, alphanumeric, or special characters  Expected if the First Word is the Surname of a Residence or Business listing. Maximum of 250 alpha, numeric, special, or alphanumeric characters.
LINEAL DESCENT	e.g. SR, JR, III. If Lineal Descent data cannot be uniquely identified, it should be included with the Listed Name Subsequent Word(s) data and placed at the end of the name data.	Optional: Maximum 10 alpha characters
TITLE(s)	e.g. MRS, LT COL, RET SGR, DR. Multiple titles are acceptable. If title data cannot be uniquely identified, it should be included with the Listed Name Subsequent Word(s) data and placed at the end of the name	Optional: Maximum of 20 alpha characters

data stream. If lineal descent is also in the Listed Name Subsequent Word(s) data field, title data should be placed following the lineal descent data.

<b>DEGREE</b>	e.g. MD, CPA, PHD. Multiple degrees are acceptable. If degree data cannot be uniquely identified, it should be included with the Listed Name Subsequent Word(s) data and placed at the end of the name data stream. If lineal descent and/or title data is also present, it should follow title data.	Optional: Maximum of 20 alpha characters
<b>NICKNAME</b>	Another name the listed subscriber may be known by.	Optional: Maximum of 20 alpha characters
<b>BUSINESS DESIGNATION</b>	Term used to identify the listed subscriber's profession, business, or location, e.g. ATTY, CARPETS, OFC	Optional: Maximum of 50 alpha characters
<b>STANDARD TELEPHONE NUMBER *</b>	<b>NPA NXX-LINE</b>	Optional: 12 characters, including space and hyphen
<b>NON-STANDARD TELEPHONE NUMBER *</b>	Telephone numbers less than or more than the standard telephone number.	Optional: Minimum of 1 digit, maximum of 22 characters, including spaces and hyphens

\* Either a Standard or Non-standard telephone is required for a zero level record unless the record is a Cross-reference listing or an Indented Listing (caption) Set record. A telephone number may, or may not be present on an Indented Listing Set record for level(s) 0-7.

**MCImetro - BellSouth Florida Interconnection Agreement**

<b>Subscriber Information</b>					
<b>Business Function</b>	<b>Long-Term Solution*</b>	<b>Real-Time Access To Data**</b>	<b>Real Time Transaction Processing</b>	<b>Frequency/ Time Interval</b>	<b>Interim Solution</b>
BellSouth provides all published Subscriber List Information	Electronic Interface - within 30 days of Agreement	N	N/A	One-time only	To be negotiated
BellSouth provides MCIm with changes to Subscriber List Information	Electronic Interface	N	N/A	same day as changes occurs	To be negotiated
BellSouth provides all Street Address Guide Information (SAG)	Electronic Interface	N	N/A	One-time only	To be negotiated
BellSouth provides changes to Street Address Guide Information (SAG)	Electronic Interface	N	N/A	same day as changes occur	To be negotiated

\*To be implemented by January 1, 1997, or agreed upon timeframe. All system availability is operational 24 hours a day, 7 days a week unless otherwise specified.

\*\* Real-Time access to real-time or most current available data, as opposed to real-time browsing of a database that may be outdated



**MCImetro - BellSouth Florida Interconnection Agreement**

<b>Other Information</b>					
<b>Business Function</b>	<b>Long-Term Solution*</b>	<b>Real-Time Access To Data**</b>	<b>Real Time Transaction Processing</b>	<b>Frequency/ Time Interval</b>	<b>Interim Solution</b>
BellSouth provides MCI <sub>m</sub> PICs available at a central office level	Electronic Interface		N/A		To be negotiated
MCI <sub>m</sub> views subscriber profile information at the line and trunk level.	Electronic Interface	Y	N/A	N/A	To be negotiated
MCI <sub>m</sub> views all features and services, including new services, trial offers and promotions available through BellSouth	Electronic Interface	Y	N/A	N/A	To be negotiated
MCI <sub>m</sub> views all services and features technically available from each switch that BellSouth may use to provide a Local Switching element.	Electronic Interface	Y	Y	N/A	To be negotiated

**MCI/metro - BellSouth Florida Interconnection Agreement**

<b>Telephone Number Reservations</b>					
<b>Business Function</b>	<b>Long-Term Solution*</b>	<b>Real-Time Access To Data**</b>	<b>Real Time Transaction Processing</b>	<b>Frequency/ Time Interval</b>	<b>Interim Solution</b>
MCI/m views available list of telephone numbers	Electronic Interface	Y	N/A	N/A	To be negotiated
MCI/m reserves/assigns telephone numbers for both simple and complex services from available BellSouth list/number services system	Electronic Interface	Y	Y	N/A	To be negotiated
BellSouth provides confirmation of simple number reservation	Electronic Interface	Y	Y	N/A	To be negotiated
BellSouth provides confirmation of complex number reservation	Electronic Interface	N	N	within 24 hours	To be negotiated

**MCImetro - BellSouth Florida Interconnection Agreement**

<b>Order Submission Business Function</b>	<b>Long-Term Solution*</b>	<b>Real-Time Access To Data**</b>	<b>Real Time Transaction Processing</b>	<b>Frequency/ Time Interval</b>	<b>Interim Solution</b>
MCIm submits order for desired resold features and services, Local Services, unbundled elements and/or combinations of elements from BellSouth	Electronic Interface	Y	Y	N/A	To be negotiated
MCIm orders local, intraLATA, InterLATA, and international service on a single order	Electronic Interface	Y	Y	N/A	To be negotiated
MCIm requests suspension, termination or restoration of service	Electronic Interface	Y	Y	N/A	To be negotiated
MCIm adjusts pending order due dates	Electronic Interface	Y	Y	N/A	To be negotiated

**MCImetro - BellSouth Florida Interconnection Agreement**

<b><i>Order Tracking</i></b>					
<b>Business Function</b>	<b>Long-Term Solution*</b>	<b>Real-Time Access To Data**</b>	<b>Real Time Transaction Processing</b>	<b>Frequency/ Time Interval</b>	<b>Interim Solution</b>
BellSouth provides acknowledgment or rejection of Service Orders to MCIm	Electronic Interface	Y	Y	within 1 hour	To be negotiated
BellSouth provides errors in Service Orders to MCIm	Electronic Interface	Y	Y	N/A	To be negotiated
BellSouth provides FOC to MCIm	Electronic Interface	N	Y	within 4 hours	To be negotiated
<b><i>Provisioning</i></b>					
BellSouth provides delay notification to MCIm	Electronic Interface	Y	Y	N/A	To be negotiated
BellSouth provides completion notification to MCIm	Electronic Interface	Y	Y	within 1 hour	To be negotiated
MCIm schedules service installations	Electronic Interface	Y	Y	N/A	To be negotiated
BellSouth provides charges on special construction to MCIm	Electronic Interface	Y	Y	N/A	BellSouth's LCSC will immediately notify MCIm by phone
BellSouth supplies MCIm with Due Date Interval Guides/Job Aids	Electronic Interface	Y	N	N/A	To be negotiated

## **MCImetro - BellSouth Florida Interconnection Agreement**

### ***MCI*** Comment

***This exhibit specifies, for each information exchange between MCI*** and BellSouth, the type of interface, whether real-time access and processing is required, and the frequency of information exchanges. This information is required to ensure that both parties are in agreement on each others' interface requirements.

**TABLE OF CONTENTS**

**ATTACHMENT IX  
SECURITY REQUIREMENTS**

Section 1	Physical Security	IX - 1
Section 2	Network Security	IX - 2
Section 3	Revenue Protection	IX - 3
Section 4	Law Enforcement Interface	IX - 3

**ATTACHMENT IX**

**SECURITY REQUIREMENTS**

***Section 1. Physical Security***

BellSouth shall exercise the same level of care it provides itself to prevent harm or damage to MCIm or its employees, agents or subscribers, or their property. BellSouth agrees to take reasonable and prudent steps to ensure the adequate protection of MCIm property located within BellSouth premises, including but not limited to:

1.1 Restricting access to MCIm equipment, support equipment, systems, tools, or spaces which contain or house MCIm equipment enclosures to MCIm employees and other authorized non-MCIm personnel to the extent necessary to perform their specific job function.

1.2 Furnishing to MCIm a current written list of BellSouth's employees which BellSouth authorizes to enter spaces which house or contain MCIm equipment or equipment enclosures, including caged areas, authorized with current facsimiles of the types of identifying credentials to be carried by such persons.

1.3 Complying at all times with security and safety procedures and requirements mutually agreed upon at the first collocation meeting for each site, including but not limited to sign-in, identification, and escort requirements while in spaces which house or contain MCIm equipment or equipment enclosures..

1.4 Assuring that the physical security and the means of ingress and admission to space that house MCIm equipment or equipment enclosures are equal to or exceed those provided for BellSouth pursuant to BellSouth Admissions Practices.

1.5 Allowing MCIm to inspect or observe spaces which house or contain MCIm equipment or equipment enclosures at any time and to furnish MCIm with all keys, entry codes, lock combinations, or other materials or information which may be needed to gain entry into any secured MCIm space.

1.6 Where BellSouth has access device systems, agreeing to coordinate MCIm's use of any access device systems, whether biometric or card reader, or types which are encoded identically or mechanical coded locks on external and or internal doors to spaces which house MCIm

equipment.

1.7 Limiting the keys or other access methods used in its systems for spaces which contain or house MCIm equipment or equipment enclosures to BellSouth employees and representatives to emergency access only. MCIm shall further have the right to change locks or other access methods on all spaces where deemed necessary for the protection and security of such spaces. In such an event, MCIm shall provide BellSouth with replacement keys or equivalent.

1.8 Ensuring that doors that provide access to MCIm equipment enclosures are equipped to protect against removal of hinge pins.

1.9 Controlling unauthorized access from passenger and freight elevators by continuous surveillance or by installing security partitions, security grills, locked gates or doors between elevator lobbies and spaces which contain or house MCIm equipment or equipment enclosures, as selected by MCIm and at MCIm's expense.

1.10 Providing prompt notification to designated MCIm personnel whenever BellSouth has determined that there has been an actual or attempted security breach. MCIm shall provide prompt notice to BellSouth when MCIm determines that an actual or attempted security breach of the MCIm secured space has occurred.

1.11 Ensuring that areas designated to house MCIm equipment are environmentally appropriate for the MCIm equipment installation, and, consistent with Attachment V, adequate to maintain proper operating conditions for the MCIm equipment.

## **Section 2. Network Security**

2.1 MCIm's secured space shall be covered by the same back-up and recovery plan used for BellSouth space in the event of a system failure or emergency.

2.2 BellSouth shall install controls and logical security as set forth in Attachment V, Section 2.17.4, to (i) disconnect a user for a pre-determined period of inactivity on authorized ports; (ii) protect subscriber proprietary information; (iii) ensure both ongoing operational and update integrity, (iv) assure that all approved system and modem access be secured through security servers and that access to or connection with a network element shall be established through a secure network or security gateway; and (v) provide security equal to or better than that which BellSouth provides to itself (which shall include Design, Development,



## **MCIm-BellSouth Florida Interconnection Agreement**

**Maintenance and Administration Security Standards for Network Elements, Network Element Support Systems, and other Computer Systems).**

**2.3 BellSouth shall provide Network Security (i) ensuring that all MCIm-approved systems and modem access are secured through MCIm-approved security devices; and (ii) ensuring that access to or connection with a network element are established through MCIm security-approved networks or gateways.**

**2.4 BellSouth agrees to comply with MCIm Corporate Security Standards, including but not limited to "MCIm Information Asset Security Standards", February, 1996, Document Number 076-0004-01-01.OF-ER and "MCIm Minimum Security Baseline Standard for Information Systems", January 1996, Document Number 076-0003-01.OF-ER.**

### ***Section 3. Revenue Protection***

**3.1 BellSouth shall make available to MCIm all present and future fraud prevention or revenue protection features, including prevention, detection, or control functionality embedded within any of the Network Elements. These features include, but are not limited to screening codes, information digits assigned such as code 07 which indicate special handling of the call is required, call blocking of domestic, international, 800, 888, 900 NPA-976 numbers.**

**3.1.1 Uncollectible or unbillable revenues resulting from, but not confined to provisioning, maintenance, or signal network routing errors shall be the responsibility of the party causing such error, and such liability shall be calculated pursuant to the methodology set forth in Attachment VIII, section 4.1.4.**

**3.1.2 Left Blank Intentionally**

**3.1.3 Left Blank Intentionally**

### ***Section 4. Law Enforcement Interface***

**Upon request by MCIm Security/Network Services, BellSouth shall provide all necessary assistance to facilitate the execution of a wiretap, call trace or dialed number recorder court order provided from law enforcement authorities. In that regard, BellSouth shall provide seven day a week / twenty-four hour a day installation and information retrieval pertaining to traps, assistance involving emergency traces and information retrieval on subscriber invoked CLASS services.**

## **ATTACHMENT X**

### **Credits for Performance Standards Failures**

Left Blank Intentionally

**AMENDMENT ONE DATED MAY 28, 1998  
TO  
MCIIm/BELLSOUTH INTERCONNECTION AGREEMENT  
DATED JUNE 19, 1997**

MCImetro Access Transmission Services, Inc. ("MCIIm") and BellSouth Telecommunications, Inc. ("BellSouth"), hereinafter referred to collectively as the "Parties," hereby agree to amend the MCIIm/BellSouth Interconnection Agreement dated June 19, 1997 ("Interconnection Agreement") pursuant to the Order of the Florida Public Service Commission issued on April 29, 1998 which establishes the recurring and non-recurring rates for certain unbundled network elements (UNEs).

NOW THEREFORE, in consideration of the mutual provisions contained herein and other good and valuable consideration, the receipt and sufficiency of which are hereby acknowledged, MCIIm and BellSouth hereby covenant and agree as follows:

1. Based on the Order issued by the Florida Public Service Commission on April 29, 1998 in Docket No. 960757, 960833, 960846, the final rates for certain rate elements which were previously ordered as interim, pending filing of cost studies, were ordered by the Florida Public Service Commission. The rates as ordered are set forth in the Rate Tables attached hereto and incorporated herein as Exhibit A consisting of three pages delineating the recurring and non-recurring charges for:
  - a) Network Interface Device (NID) ;
  - b) 2 wire and 4-wire loop distribution;
  - c) 2-wire ADSL-compatible loop;
  - d) 2-wire and 4-wire HDSL-compatible loop;
  - e) Physical collocation;
  - f) Virtual collocation
  - g) Directory Assistance
  - h) Dedicated Transport;
  - i) 4-wire analog port
  
2. Attachment I of the Florida Interconnection Agreement is hereby amended to incorporate the final rates for those certain rate elements that were originally ordered as interim as set forth in Exhibit A of this Amendment.
  
3. All of the other provisions, including all other rates listed in Attachment I of the Florida Interconnection Agreement, dated June 19, 1997, shall remain in full force and effect.

**ORIGINAL**

4. Either or both of the Parties shall submit this Amendment to the Florida Public Service Commission on or before May 29, 1998 as ordered by the Florida Public Service Commission. However, the Parties acknowledge that the terms and/or rates of this Amendment were established pursuant to the afore-referenced Order of the Florida Public Service Commission. Any or all of the terms or rates of this Amendment may be altered or abrogated by a successful challenge to the Amendment and/or the Order requiring the Amendment and/or any order approving this Amendment as permitted by applicable law. By signing this Amendment, neither Party waives any right to pursue such a challenge.
5. Either or both of the Parties shall submit this Amendment to the Florida Public Service Commission or other regulatory body having jurisdiction over the subject matter of this Amendment, for approval subject to Section 252(e) of the federal Telecommunications Act of 1996.

IN WITNESS WHEREOF, the Parties hereto have caused this Amendment to be executed by their respective duly authorized representatives on the date indicated below.

**MCImetro Access Transmission  
Services, Inc.**

By:

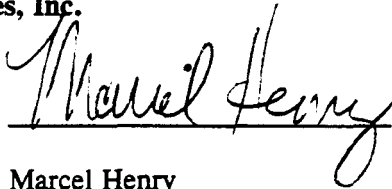

Name: Marcel Henry  
Title: Regional Vice President

Date: May 28, 1998

**BellSouth Telecommunications, Inc.**

By:

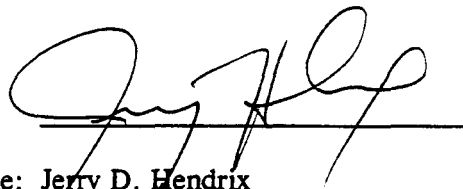

Name: Jerry D. Hendrix  
Title: Director-Interconnection Services-  
Pricing

Date: 5-28-98

**BELLSOUTH/MCI RATES - FLORIDA  
UNBUNDLED NETWORK ELEMENTS**

<b>NIDs</b>	
NID, per month	\$1.08
Installation of 2-Wire/4-Wire ALEC NID, NRC - 1st	\$70.32
Installation of 2-Wire/4-Wire ALEC NID, NRC - Add'l	\$54.35
NID to NID Cross Connect, 2-Wire or 4-Wire, NRC	\$6.15
<b>LOOP, INCLUDING NID</b>	
2-Wire Asymmetrical Dig Sub Line (ADSL)/Compatible Loop, per mo	\$15.81
NRC - 1 <sup>st</sup>	\$113.85
NRC - Add'l	\$99.61
2-Wire High Bit Rate Dig Sub Line (HDSL)/Compatible Loop, per mo	\$12.12
NRC - 1 <sup>st</sup>	\$113.85
NRC - Add'l	\$99.61
4-Wire High Bit Rate Dig Sub Line (HDSL)/Compatible Loop, per mo	\$18.24
NRC - 1 <sup>st</sup>	\$116.91
NRC - Add'l	\$101.71
<b>SUB-LOOPS</b>	
Loop Distribution per 2-Wire Analog VG Loop (Incl NID), per month	\$8.57
NRC - 1 <sup>st</sup>	\$78.29
NRC - Add'l	\$58.33
Loop Distribution per 4-Wire Analog VG Loop (Incl NID), per month	\$11.29
NRC - 1 <sup>st</sup>	\$112.07
NRC - Add'l	\$92.11
<b>UNBUNDLED LOCAL EXCHANGE SWITCHING (PORTS)</b>	
4-Wire Analog VG Port, per month	\$9.14
NRC - 1 <sup>st</sup>	\$5.86
NRC - Add'l	\$5.86
<b>UNBUNDLED TRANSPORT</b>	
<b>Interoffice Transport - Dedicated - DS1</b>	
Interoffice Transport - Dedicated DS1 Level Interoffice per mile per mo	\$0.6013
Interoffice Transport - Dedicated DS1 - facilities term per mo	\$101.61
NRC - 1 <sup>st</sup>	\$45.91
NRC - Add'l	\$44.18
Interoffice Transport - Local Channel DS1, per month	\$44.35
NRC - 1 <sup>st</sup>	\$246.50
NRC - Add'l	\$230.49
<b>DIRECTORY ASSISTANCE SERVICES</b>	
<b>Directory Transport</b>	
Directory Transport - Local Channel DS1, per month	\$43.64
NRC - 1 <sup>st</sup>	\$242.45
NRC - Add'l	\$226.44
Directory Transport - Dedicated DS1 Level Interoffice per mile per mo	\$0.6013
Directory Transport - Dedicated DS1 Level Interoffice per fac term per mo	\$99.79
NRC - 1 <sup>st</sup>	\$45.91
NRC - Add'l	\$44.18
Directory Transport-Installation NRC, per trunk or signaling connection	
NRC - 1 <sup>st</sup>	\$332.42
NRC - Add'l	\$8.82

## Physical Collocation Rates

Rate Element Description	Unit	Recurring Rate (RC)	Non-Recurring Rate (NRC)
Application Fee/Planning Fee	Per Request	\$15.53	\$3,248
Space Preparation Fee	Per Request	NA	ICB
Space Construction			
Wire Cage	Per first 100 sq. Ft.	\$41.99	NA
Gypsum Board Cage	Per first 100 sq. Ft.	\$84.10	NA
Fire Rated Cage	Per first 100 sq. Ft.	\$99.73	NA
Wire Cage	Per add'l 50 sq. Ft.	\$4.14	NA
	Per add'l 50 sq. Ft.	\$9.35	NA
	Per add'l 50 sq. Ft.	\$11.30	NA
Floor Space/Land and Building	Per sq. Ft.	\$4.25	NA
Cable Installation	Per Cable	\$2.77	\$1,056
Cable Rack		\$22.94	NA
Power	Per Amp	\$6.95	NA
Cross Connects			
2-wire	Per 100 Circuits	\$5.24	\$1,157
4-wire	Per 100 Circuits	\$5.24	\$1,157
DS-1/DCS	Per 28 Circuits	\$226.39	\$1,950
DS-1/DSX	Per 28 Circuits	\$11.51	\$1,950
DS-3/DCS	Per Circuit	\$56.97	\$528
DS-3/DSX	Per Circuit	\$10.06	\$528
Optical Circuits	Per Connection	\$6.46	\$2,431
Security Escort			
Regular Time	Per ¼ hour	NA	\$10.89
Overtime	Per ¼ hour	NA	\$13.64
Premium Time	Per ¼ hour	NA	\$16.40
Security Access Cards	Per Request (5 Cards)	NA	\$85.12

## Virtual Collocation Rates

Rate Element Description	Unit	Recurring Rate (RC)	Non-Recurring Rate (NRC)
Application Fee/Planning Fee	Initial Request	NA	\$4,122
	Add'l Cable Request	NA	\$1,249
Floor Space/Land and Building	Per Sq. Ft.	\$4.25	NA
Cable Installation	Per Cable	\$12.45	\$965
Cable Rack	Per ¼ Rack	\$2.24	NA
Power	Per Amp	\$6.95	NA
Cross Connects			
2-Wire	Per 100 Circuits	\$5.02	\$1,157
4-Wire	Per 100 Circuits	\$5.02	\$1,157
DS-1-DCS	Per 28 Circuits	\$226.39	\$1,950
DS-1-DSX	Per 28 Circuits	\$11.51	\$1,950
DS-3-DCS	Per Circuit	\$56.97	\$528
DS-3-DSX	Per Circuit	\$10.06	\$528
Optical Circuits	Per Connection	\$6.71	\$2,431
Virtual to Virtual Connection			
Fiber	Per Cable	\$.19	\$526.17
DS-1/DS-3	Per Cable	\$.17	\$134.46
Equipment Maintenance and Security Escort			
Regular Time	Per ¼ hour	NA	\$10.89
Overtime	Per ¼ hour	NA	\$13.64
Premium Time	Per ¼ hour	NA	\$16.40

**SECOND AMENDMENT  
TO  
MCImetro/BELLSOUTH INTERCONNECTION AGREEMENT  
DATED  
JUNE 19, 1997**

Pursuant to this Amendment to MCImetro/BellSouth Interconnection Agreement (the "Amendment"), for the state of Florida, MCImetro Access Transmission Services, Inc. ("MCI") and BellSouth Telecommunications, Inc. ("BellSouth"), hereinafter referred to collectively as the "Parties," hereby agree to amend the MCImetro/BellSouth Interconnection Agreement dated June 19, 1997 ("Interconnection Agreement")

NOW THEREFORE, in consideration of the mutual provisions contained herein and other good and valuable consideration, the receipt and sufficiency of which are hereby acknowledged, MCI and BellSouth hereby covenant and agree as follows:

1. On April 29, 1998 the Florida Public Service Commission issued Order No. PSC-98-0604-FOF-TP, in Dockets Nos. 960757-TP, 960833-TP, and 980846-TP. This Order set final rates for certain rate elements which were previously ordered as interim, pending filing of cost studies. On October 23, 1998 the Commission issued an Ammendatory Order to Order No. PSC-98-0604-FOF-TP to correct the final \$101.61 rate for DS-1 Facility Termination as set forth in Table 1, page 13 of the original Order, which was incorrect. The approved rate is \$99.79. The final rates as corrected are as set forth in the Rate Tables attached hereto and incorporated herein as Exhibit A consisting of three pages delineating the recurring and non-recurring charges for:

- a) Network Interface Device (NID);
- b) 2 wire and 4-wire loop distribution;
- c) 2-wire ADSL compatible loop;
- d) 2-wire and 4-wire HDSL compatible loop;
- e) Physical collocation;
- f) Virtual collocation;
- g) Directory Assistance;
- h) Dedicated Transport; and
- i) 4-wire analog port

2. Attachment I of the Florida Interconnection Agreement is hereby amended to incorporate the final rates for those certain rate elements as set forth in Exhibit A of this Amendment.

**ORIGINAL**



3. All of the other provisions, including all other rates listed in Attachment I of the Florida Interconnection Agreement, dated June 19, 1997, shall remain in full force and effect.

4. Either or both of the Parties shall submit this Amendment to the Florida Public Service Commission on or before November 23, 1998 as ordered by the Florida Public Service Commission. However, the Parties acknowledge that the terms and/or rates of this Amendment were established pursuant to the afore-referenced Order of the Florida Public Service Commission. Any or all of the terms or rates of this Amendment may be altered or abrogated by a successful challenge to the Amendment and/or the Order requiring the Amendment and/or any order approving this Amendment as permitted by applicable law. By signing this Amendment, neither Party waives any right to pursue such a challenge.

5. Either or both of the Parties shall submit this Amendment to the Florida Public Service Commission or other regulatory body having jurisdiction over the subject matter of this Amendment, for approval subject to Section 252(e) of the federal Telecommunications Act of 1996.

IN WITNESS WHEREOF, the Parties hereto have caused this Amendment to be executed by their respective duly authorized representatives on the date indicated below.

**MCImetro Access Transmission Services, Inc.**

By: 

Name: Marcel Henry  
Title: Vice President

Date: 19 Nov 1998

**BellSouth Telecommunications, Inc.**

By: 

Name: Jerry D. Hendrix  
Title: Director-Interconnection Services-Pricing

Date: 11/20/98

**BELLSOUTH/MCI RATES - FLORIDA  
UNBUNDLED NETWORK ELEMENTS**

<b>NIDs</b>	
NID, per month	\$1.08
Installation of 2-Wire/4-Wire ALEC NID, NRC - 1st	\$70.32
Installation of 2-Wire/4-Wire ALEC NID, NRC - Add'l	\$54.35
NID to NID Cross Connect, 2-Wire or 4-Wire, NRC	\$6.15
<b>LOOP, INCLUDING NID</b>	
2-Wire Asymmetrical Dig Sub Line (ADSL)/Compatible Loop, per mo	\$15.81
NRC - 1 <sup>st</sup>	\$113.85
NRC - Add'l	\$99.61
2-Wire High Bit Rate Dig Sub Line (HDSL)/Compatible Loop, per mo	\$12.12
NRC - 1 <sup>st</sup>	\$113.85
NRC - Add'l	\$99.61
4-Wire High Bit Rate Dig Sub Line (HDSL)/Compatible Loop, per mo	\$18.24
NRC - 1 <sup>st</sup>	\$116.91
NRC - Add'l	\$101.71
<b>SUB-LOOPS</b>	
Loop Distribution per 2-Wire Analog VG Loop (Incl NID), per month	\$8.57
NRC - 1 <sup>st</sup>	\$78.29
NRC - Add'l	\$58.33
Loop Distribution per 4-Wire Analog VG Loop (Incl NID), per month	\$11.29
NRC - 1 <sup>st</sup>	\$112.07
NRC - Add'l	\$92.11
<b>UNBUNDLED LOCAL EXCHANGE SWITCHING (PORTS)</b>	
4-Wire Analog VG Port, per month	\$9.14
NRC - 1 <sup>st</sup>	\$5.86
NRC - Add'l	\$5.86
<b>UNBUNDLED TRANSPORT</b>	
<b>Interoffice Transport - Dedicated - DS1</b>	
Interoffice Transport - Dedicated DS1 Level Interoffice per mile per mo	\$0.6013
Interoffice Transport - Dedicated DS1 - facilities term per mo	\$99.79
NRC - 1 <sup>st</sup>	\$45.91
NRC - Add'l	\$44.18
Interoffice Transport - Local Channel DS1, per month	\$44.35
NRC - 1 <sup>st</sup>	\$246.50
NRC - Add'l	\$230.49
<b>DIRECTORY ASSISTANCE SERVICES</b>	
<b>Directory Transport</b>	
Directory Transport - Local Channel DS1, per month	\$43.64
NRC - 1 <sup>st</sup>	\$242.45
NRC - Add'l	\$226.44
Directory Transport - Dedicated DS1 Level Interoffice per mile per mo	\$0.6013
Directory Transport - Dedicated DS1 Level Interoffice per fac term per mo	\$99.79
NRC - 1 <sup>st</sup>	\$45.91
NRC - Add'l	\$44.18
Directory Transport-Installation NRC, per trunk or signaling connection	
NRC - 1 <sup>st</sup>	\$206.06
NRC - Add'l	\$4.71

## Physical Collocation Rates

Rate Element Description	Unit	Recurring Rate (RC)	Non-Recurring Rate (NRC)
Application Fee/Planning Fee	Per Request	\$15.53	\$3,248
Space Preparation Fee	Per Request	NA	ICB
Space Construction			
Wire Cage	Per first 100 sq. Ft.	\$41.99	NA
Gypsum Board Cage	Per first 100 sq. Ft.	\$84.10	NA
Fire Rated Cage	Per first 100 sq. Ft.	\$99.73	NA
Wire Cage	Per add'l 50 sq. Ft.	\$4.14	NA
	Per add'l 50 sq. Ft.	\$9.35	NA
	Per add'l 50 sq. Ft.	\$11.30	NA
Floor Space/Land and Building	Per sq. Ft.	\$4.25	NA
Cable Installation	Per Cable	\$2.77	\$1,056
Cable Rack		\$22.94	NA
Power	Per Amp	\$6.95	NA
Cross Connects			
2-wire	Per 100 Circuits	\$5.24	\$1,157
4-wire	Per 100 Circuits	\$5.24	\$1,157
DS-1/DCS	Per 28 Circuits	\$226.39	\$1,950
DS-1/DSX	Per 28 Circuits	\$11.51	\$1,950
DS-3/DCS	Per Circuit	\$56.97	\$528
DS-3/DSX	Per Circuit	\$10.06	\$528
Optical Circuits	Per Connection	\$6.46	\$2,431
Security Escort			
Regular Time	Per ¼ hour	NA	\$10.89
Overtime	Per ¼ hour	NA	\$13.64
Premium Time	Per ¼ hour	NA	\$16.40
Security Access Cards	Per Request (5 Cards)	NA	\$85.12

## Virtual Collocation Rates

Rate Element Description	Unit	Recurring Rate (RC)	Non-Recurring Rate (NRC)
Application Fee/Planning Fee	Initial Request	NA	\$4,122
	Add'l Cable Request	NA	\$1,249
Floor Space/Land and Building	Per Sq. Ft.	\$4.25	NA
Cable Installation	Per Cable	\$12.45	\$965
Cable Rack	Per ¼ Rack	\$2.24	NA
Power	Per Amp	\$6.95	NA
Cross Connects			
2-Wire	Per 100 Circuits	\$5.02	\$1,157
4-Wire	Per 100 Circuits	\$5.02	\$1,157
DS-1-DCS	Per 28 Circuits	\$226.39	\$1,950
DS-1-DSX	Per 28 Circuits	\$11.51	\$1,950
DS-3-DCS	Per Circuit	\$56.97	\$528
DS-3-DSX	Per Circuit	\$10.06	\$528
Optical Circuits	Per Connection	\$6.71	\$2,431
Virtual to Virtual Connection			
Fiber	Per Cable	\$ .19	\$526.17
DS-1/DS-3	Per Cable	\$ .17	\$134.46
Equipment Maintenance and Security Escort			
Regular Time	Per ¼ hour	NA	\$10.89
Overtime	Per ¼ hour	NA	\$13.64
Premium Time	Per ¼ hour	NA	\$16.40

**THIRD AMENDMENT  
TO  
MCImetro/BELLSOUTH INTERCONNECTION AGREEMENT  
DATED  
JUNE 19, 1997**

Pursuant to this Amendment to MCImetro/BellSouth Interconnection Agreement (the "Amendment"), for the state of Florida, MCImetro Access Transmission Services, Inc. ("MCI") and BellSouth Telecommunications, Inc. ("BellSouth"), hereinafter referred to collectively as the "Parties," hereby agree to amend the MCImetro/BellSouth Interconnection Agreement dated June 19, 1997 ("Interconnection Agreement")

NOW THEREFORE, in consideration of the mutual provisions contained herein and other good and valuable consideration, the receipt and sufficiency of which are hereby acknowledged, MCI and BellSouth hereby covenant and agree as follows:

1. Table 1, of Attachment I is hereby amended to include the following:

	<b>Recurring Rate</b>	<b>Non-Recurring Rate</b>
Selective Routing for Line CLASS Codes	\$0.00	\$230.00, Per End Office, Per Line CLASS code

2. Either or both of the Parties shall submit this Amendment to the Florida Public Service Commission or other regulatory body having jurisdiction over the subject matter of this Amendment, for approval subject to Section 252(e) of the federal Telecommunications Act of 1996.

IN WITNESS WHEREOF, the Parties hereto have caused this Amendment to be executed by their respective duly authorized representatives on the date indicated below.

**MCImetro Access Transmission Services, Inc.**

By: \_\_\_\_\_

Name: Marcel Henry  
Title: Vice President

Date: 9-1-97

**BellSouth Telecommunications, Inc.**

By: \_\_\_\_\_

Name: Jerry D. Hendrix  
Title: Director-Interconnection Services-Pricing

Date: 9/4/98