



Susan S. Masterton
Attorney

VP Law/External Relations
Post Office Box 2214
Tallahassee, FL 32316-2214
Voice 850 599 1560
Fax 850 878 0777
susan.masterton@mail.sprint.com

August 26, 1999

Ms. Blanca S. Bayo, Director
Division of Records and Reporting
Florida Public Service Commission
2540 Shumard Oak Boulevard
Tallahassee, Florida 32399-0850

RECORDS AND
REPORTING

AUG 26 PM 2:23

RECEIVED-FPSC

991223-TP

Re: Petition of Sprint-Florida, Incorporated
for Approval of a Interconnection and Resale
Agreement with Dakota Services Limited

Dear Ms. Bayo:

Enclosed for filing is the original and five (5) copies of
Sprint-Florida, Inc.'s Petition for approval of a
Interconnection and Resale Agreement with Dakota Services
Limited.

Please acknowledge receipt and filing of the above by
stamping the duplicate copy of this letter and returning the
same to this writer.

Thank you for your assistance in this matter.

Sincerely,

Susan S. Masterton

Susan S. Masterton

RECEIVED & FILED
[Signature]
FPSC BUREAU OF RECORDS

SSM/th

Enclosures

DOCUMENT NUMBER-DATE

10245 AUG 26 99

FPSC-RECORDS/REPORTING

BEFORE THE FLORIDA PUBLIC SERVICE COMMISSION

In re: Petition for Approval) Docket No.
of Interconnection and Resale)
Agreement Between)
Sprint- Florida, Incorporated) Filed: August 26, 1999
And Dakota Services Limited)

PETITION OF SPRINT-FLORIDA, INCORPORATED
FOR APPROVAL OF INTERCONNECTION AND RESALE AGREEMENT
WITH DAKOTA SERVICES LIMITED

Sprint-Florida, Incorporated (Sprint-Florida) files this Petition with the Florida Public Service Commission seeking approval of an Interconnection and Resale Agreement, which Sprint-Florida has entered with Dakota Services Limited. In support of this Petition, Sprint-Florida states:

Florida Telecommunications law, Chapter 364, Florida Statutes as amended, requires local exchange carriers such as Sprint-Florida to negotiate "mutually acceptable prices, terms and conditions of interconnection and for the resale of services and facilities" with alternative local exchange carriers. Section 364.162, Florida Statutes (1996).

2. The Telecommunications Act of 1996, requires that any such "agreement adopted by negotiation or arbitration shall be submitted for approval to the State Commission" 47 U.S.C. §252(e).

DOCUMENT NUMBER-DATE

10245 AUG 26 89

FPSC-RECORDS/REPORTING

3. In accordance with the above provisions, Sprint-Florida has entered an Agreement with Dakota Services Limited, which is or will be a carrier certificated as an alternative local exchange carrier as that term is defined in Section 364.02(1), Florida Statutes (1996). This Agreement was executed on February 15, 1999, and is attached hereto as Attachment A.

4. Under the Federal Act, an agreement can be rejected by the State Commission only if the commission finds that the agreement or any portion thereof discriminates against a telecommunications carrier not a party to the agreement or if the implementation of that agreement is not consistent with the public interest, convenience and necessity. 47 U.S.C. §252(e)(2).

5. The Agreement with Dakota Services Limited does not discriminate against other similarly situated carriers, which may order services and facilities from Sprint-Florida under similar terms and conditions. The Agreement is also consistent with the public interest, convenience and necessity. As such, Sprint-Florida seeks approval of the Agreement from the Florida Public Service Commission as required by the Federal statutory provisions noted above.

Wherefore, Sprint-Florida respectfully requests that the Florida Public Service Commission approve the Interconnection and Resale agreement between Sprint-Florida and Dakota Services Limited.

Respectfully submitted this 26th day of August, 1999.

Sprint-Florida, Incorporated

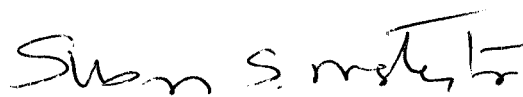
A handwritten signature in black ink that reads "Susan S. Masterton". The signature is written in a cursive style with a horizontal line underneath it.

Susan S. Masterton

Attorney

Sprint-Florida, Incorporated

Post Office Box 2214

MS: FLTLHO0107

Tallahassee, Florida 32316

850/599-1560



**MASTER INTERCONNECTION AND RESALE AGREEMENT
FOR THE STATE OF FLORIDA**

January 1, 1999

Dakota Services Limited

and

Sprint-Florida, Incorporated

TABLE OF CONTENTS

Page No.

PART A - DEFINITIONS

1. DEFINED TERMS.....	2
------------------------------	----------

PART B - GENERAL TERMS AND CONDITIONS

1. SCOPE OF THIS AGREEMENT	12
2. REGULATORY APPROVALS.....	12
3. TERM AND TERMINATION.....	13
4. POST TERMINATION INTERIM SERVICE ARRANGEMENTS	14
5. CHARGES AND PAYMENT	15
6. AUDITS AND EXAMINATIONS	16
7. INTELLECTUAL PROPERTY RIGHTS.....	17
8. LIMITATION OF LIABILITY	17
9. INDEMNIFICATION.....	18
10. BRANDING.....	19
11. CONFIDENTIALITY AND PUBLICITY	19
12. DISCLAIMER OF WARRANTIES.....	20
13. ASSIGNMENT AND SUBCONTRACT	21
14. GOVERNING LAW	21
15. RELATIONSHIP OF PARTIES	21
16. NO THIRD PARTY BENEFICIARIES.....	21
17. NOTICES.....	22
18. WAIVERS.....	22
19. SURVIVAL.....	22
20. FORCE MAJEURE.....	23
21. DISPUTE RESOLUTION	23
22. COOPERATION ON FRAUD.....	24
23. TAXES	24

24. AMENDMENTS AND MODIFICATIONS	24
25. SEVERABILITY.....	25
26. HEADINGS NOT CONTROLLING.....	25
27. ENTIRE AGREEMENT	25
28. COUNTERPARTS.....	25
29. SUCCESSORS AND ASSIGNS.....	25
30. IMPLEMENTATION PLAN.....	25
31. FEDERAL JURISDICTIONAL AREAS.....	27
ATTACHMENT I - GENERAL PRINCIPLES	
1. PRICE SCHEDULE	30
2. LOCAL SERVICE RESALE.....	30
3. INTERCONNECTION AND RECIPROCAL COMPENSATION.....	30
4. UNBUNDLED NETWORK ELEMENTS	31
ATTACHMENT II - LOCAL RESALE	
1. TELECOMMUNICATIONS SERVICES PROVIDED FOR RESALE	59
2. GENERAL TERMS AND CONDITIONS.....	59
ATTACHMENT III - NETWORK ELEMENTS	
1. GENERAL.....	62
2. UNBUNDLED NETWORK ELEMENTS	62
3. BONA FIDE REQUEST PROCESS FOR FURTHER UNBUNDLING.....	63
4. NETWORK INTERFACE DEVICE.....	64
5. LOOP	65
6. LOCAL SWITCHING.....	66
7. TANDEM SWITCHING	67
8. TRANSPORT	68
9. SIGNALING SYSTEMS AND DATABASES	69
10. OPERATOR SERVICES	73
11. DIRECTORY ASSISTANCE SERVICE.....	74
ATTACHMENT IV - INTERCONNECTION	

1.	LOCAL INTERCONNECTION TRUNK ARRANGEMENT	75
2.	INTERCONNECTION COMPENSATION MECHANISMS	76
3.	SIGNALING	77
4.	NETWORK SERVICING	78
5.	NETWORK MANAGEMENT	79
6.	USAGE MEASUREMENT	80
7.	TRANSIT TRAFFIC	80
8.	RESPONSIBILITIES OF THE PARTIES	81
ATTACHMENT V - INTERIM NUMBER PORTABILITY		
1.	SPRINT PROVISION OF INTERIM NUMBER PORTABILITY	83
2.	INTERIM NUMBER PORTABILITY	83
3.	REQUIREMENTS FOR INP	84
ATTACHMENT VI - LOCAL NUMBER PORTABILITY		
1.	INTRODUCTION	87
2.	TRANSITION FROM INP TO LNP	87
3.	TESTING	88
4.	ENGINEERING AND MAINTENANCE	88
5.	E911/911	88
6.	BILLING	89
ATTACHMENT VII - GENERAL BUSINESS REQUIREMENTS		
1.	PROCEDURES	90
2.	ORDERING AND PROVISIONING	91
3.	BILLING	97
4.	PROVISION OF SUBSCRIBER USAGE DATA	99
5.	GENERAL NETWORK REQUIREMENTS	103
6.	MISCELLANEOUS SERVICES AND FUNCTIONS	105
ATTACHMENT VIII - REPORTING STANDARDS		
1.	GENERAL	120
2.	PARITY AND QUALITY MEASUREMENTS	120



INTERCONNECTION AND RESALE AGREEMENT

This Interconnection and Resale Agreement (the "Agreement"), entered into this 1st day of January, 1999, is entered into by and between Dakota Services Limited ("CLEC"), a Wisconsin corporation, and Sprint-Florida, Incorporated ("Sprint"), a Florida corporation, to establish the rates, terms and conditions for local interconnection, local resale, and purchase of unbundled network elements (individually referred to as the "service" or collectively as the "services").

WHEREAS, the Parties wish to interconnect their local exchange networks for the purposes of transmission and termination of calls, so that customers of each can receive calls that originate on the other's network and place calls that terminate on the other's network, and for CLEC's use in the provision of exchange access ("Local Interconnection"); and

WHEREAS, CLEC wishes to purchase Telecommunications Services for resale to others, and Sprint is willing to provide such service; and

WHEREAS, CLEC wishes to purchase unbundled network elements, ancillary services and functions and additional features ("Network Elements"), and to use such services for itself or for the provision of its Telecommunications Services to others, and Sprint is willing to provide such services; and

WHEREAS, the Parties intend the rates, terms and conditions of this Agreement, and their performance of obligations thereunder, to comply with the Communications Act of 1934, as amended (the "Act"), the Rules and Regulations of the Federal Communications Commission ("FCC"), and the orders, rules and regulations of the Florida Public Service Commission (the "Commission"); and

WHEREAS, the parties wish to replace any and all other prior agreements, written and oral, applicable to the state of Florida.

Now, therefore, in consideration of the terms and conditions contained herein, CLEC and Sprint hereby mutually agree as follows:

PART A -- DEFINITIONS

1. DEFINED TERMS

- 1.1. Certain terms used in this Agreement shall have the meanings as otherwise defined throughout this Agreement. Other terms used but not defined herein will have the meanings ascribed to them in the Act or in the Rules and Regulations of the FCC or the Commission. The Parties acknowledge that other terms appear in this Agreement which are not defined or ascribed as stated above. The parties agree that any such terms shall be construed in accordance with their customary usage in the telecommunications industry as of the effective date of this Agreement.
- 1.2. "911 Site Administrator" is a person assigned by CLEC to establish and maintain E911 service location information for its subscribers.
- 1.3. "911 Service" means a universal telephone number which gives the public direct access to the Public Safety Answering Point (PSAP). Basic 911 service collects 911 calls from one or more local exchange switches that serve a geographic area. The calls are then sent to the correct authority designated to receive such calls.
- 1.4. "Access Service Request (ASR)" means the industry standard forms and supporting documentation used for ordering Access Services. The ASR may be used to order trunking and facilities between CLEC and Sprint for Local Interconnection.
- 1.5. "Access Services" refers to interstate and intrastate switched access and private line transport services.
- 1.6. "Act" means the Communications Act of 1934, as amended.
- 1.7. "Affiliate" is as defined in the Act.
- 1.8. "Ancillary Traffic" means all traffic destined for ancillary services, or that may have special billing requirements, including, but not limited to the following:
 - 1.8.1. Directory Assistance;
 - 1.8.2. 911/E911;
 - 1.8.3. Operator call termination (busy line interrupt and verify); and Information services requiring special billing (e.g., 900 and 950).
- 1.9. "Automated Message Accounting (AMA)" is the structure inherent in switch technology that initially records telecommunication message information. AMA format is contained in the Automated Message Accounting document, published by Bellcore as GR-1100-CORE which defines the industry standard for message recording.
- 1.10. "Automatic Location Identification (ALI)" is a feature developed for E911 systems that provides for a visual display of the caller's telephone number, address and the names of the emergency response agencies that are responsible for that address.

- 1.11. “Automatic Location Identification/Data Management System (ALI/DMS)” means the emergency service (E911/911) database containing subscriber location information (including name, address, telephone number, and sometimes special information from the local service provider) used to determine to which Public Safety Answering Point (PSAP) to route the call.
- 1.12. “ALI Gateway“ is a telephone company computer facility that interfaces with CLEC’s 911 administrative site to receive Automatic Location Identification data from CLEC.
- 1.13. “Automatic Number Identification (ANI)” is a feature that identifies and displays the number of a telephone line that originates a call.
- 1.14. “Automatic Route Selection (ARS)” is a service feature associated with a specific grouping of lines that provides for automatic selection of the least expensive or most appropriate transmission facility for each call based on criteria programmed into the system.
- 1.15. “ATU – C” refers to an ADSL Transmission Unit – Central Office.
- 1.16. “ATU – R” refers to an ADSL Transmission Unit – Remote.
- 1.17. “Busy Line Verify/Busy Line Verify Interrupt (BLV/BLVI)” means an operator call in which the caller inquires as to the busy status of, or requests an interruption of a call on another subscriber’s telephone line.
- 1.18. “Business Day(s)” means the days of the week excluding Saturdays, Sundays, and all Sprint holidays.
- 1.19. “Carrier Access Billing System (CABS)” is the system which is defined in a document prepared under the direction of the Billing Committee of the OBF. The CABS document is published by Bellcore in Volumes 1, 1A, 2, 3, 3A, 4 and 5 as Special Reports SR-OPT-001868, SR-OPT-0011869, SR-OPT-001871, SR-OPT-001872, SR-OPT-001873, SR-OPT-001874, and SR-OPT-001875, respectively, and contains the recommended guidelines for the billing of access and other connectivity services. Sprint’s carrier access billing system is its Carrier Access Support System (CASS). CASS mirrors the requirements of CABS.
- 1.20. “Common Channel Signaling (CCS)” is a method of digitally transmitting call set-up and network control data over a digital signaling network fully separate from the public switched telephone network that carries the actual call.
- 1.21. “Calling Party Number (CPN)” is CCS parameter which refers to the number transmitted through the network identifying the calling party.
- 1.22. “Central Office Switch” (“Central Office”, or “CO”), “End Office”, or “Tandem”, or Remote Switch are switching facilities within the public switched telecommunications network, including, but not limited to:
 - 1.22.1. “End Office Switch” is a switch from which end user Telephone Exchange Services are directly connected and offered.

- 1.22.2. "Tandem Switch" is a switch which is used to connect and switch trunk circuits between and among Central Office Switches.
- 1.22.3. "Remote Switch" is a switch that is away from the host or control office. All or most of the central control equipment for the remote switch is located at the host or control office.
- 1.23. "Centrex" means a Telecommunications Service associated with a specific grouping of lines that uses central office switching equipment for call routing to handle direct dialing of calls, and to provide numerous private branch exchange-like features.
- 1.24. "Charge Number" is a CCS parameter which refers to the number transmitted through the network identifying the billing number of the calling party.
- 1.25. "CLASS/LASS" (Bellcore Service Mark) refers to service features that utilize the capability to forward a calling party's number between end offices as part of call setup. Features include Automatic Callback, Automatic Recall, Caller ID, Call Trace, and Distinctive Ringing.
- 1.26. "Competitive Local Exchange Carrier (CLEC) or Alternative Local Exchange Carrier (ALEC)" means any entity or person authorized to provide local exchange services in competition with an ILEC .
- 1.27. "CLEC 911 Database Records" are the CLEC subscriber records to be provided by CLEC to Sprint for inclusion in Sprint's E911 database.
- 1.28. "Commission" means the Florida Public Service Commission.
- 1.29. "Common Transport" provides a local interoffice transmission path between the Sprint Tandem Switch and a Sprint or CLEC end office switch. Common Transport is shared between multiple customers and is required to be switched at the Tandem.
- 1.30. "Confidential and/or Proprietary Information" has the meaning set forth in Article 11 of Part A -- General Terms and Conditions.
- 1.31. "Contract Year" means a twelve- (12) month period during the term of the contract commencing on the Effective Date and each anniversary thereof.
- 1.32. "Control Office" is an exchange carrier center or office designated as the Party's single point of contact for the provisioning and maintenance of its portion of local interconnection arrangements.
- 1.33. "Custom Calling Features" means a set of Telecommunications Service features available to residential and single-line business customers including call-waiting, call-forwarding and three-party calling.
- 1.34. "Customer Proprietary Network Information (CPNI)" means:
- 1.34.1. information that relates to the quantity, technical configuration, type, destination,

and amount of use of a Telecommunications Service subscribed to by any customer of a Telecommunications Carrier, and that is made available to the carrier by the customer solely by virtue of the carrier customer relationship; and

- 1.34.2. information contained in the bills pertaining to telephone exchange service or telephone toll service received by a customer of a carrier.
- 1.35. "Database Management System (DBMS)" is a computer process used to store, sort, manipulate and update the data required to provide selective routing and ALL.
- 1.36. "Dedicated Transport" provides a local interoffice transmission path between Sprint and/or CLEC central offices. Dedicated Transport is limited to the use of a single customer and does not require switching at a Tandem.
- 1.37. "Directory Assistance Database" refers to any subscriber record used by Sprint in its provision of live or automated operator-assisted directory assistance including but not limited to 411, 555-1212, NPA-555-1212.
- 1.38. "Directory Assistance Services" provides listings to callers. Directory Assistance Services may include the option to complete the call at the caller's direction.
- 1.39. "Discloser" means that Party to this Agreement which has disclosed Confidential Information to the other Party.
- 1.40. "DSLAM" refers to a Digital Subscriber Line Access Multiplexer.
- 1.41. "Duct" is a single enclosed path to house facilities to provide telecommunications services.
- 1.42. "Enhanced 911 Service (E911)" means a telephone communication service which will automatically route a call dialed "9-1-1" to a designated public safety answering point (PSAP) attendant and will provide to the attendant the calling party's telephone number and, when possible, the address from which the call is being placed and the emergency response agencies responsible for the location from which the call was dialed.
- 1.43. "E911 Message Trunk" is a dedicated line, trunk or channel between two central offices or switching devices which provides a voice and signaling path for E911 calls.
- 1.44. "Effective Date" is either thirty (30) days after the date referenced in the opening paragraph of the Agreement, the filing date of this Agreement with the Commission if the Commission has defined the Effective Date as such, or as otherwise required by the Commission. Absent specific Commission rules to the contrary, the Effective Date shall be no earlier than proof of CLEC certification in the jurisdiction.
- 1.45. "Electronic Interfaces" means access to operations support systems consisting of preordering, ordering, provisioning, maintenance and repair and billing functions.
- 1.46. "Emergency Response Agency" is a governmental entity authorized to respond to requests from the public to meet emergencies.

- 1.47. “Environmental Hazard” means any substance the presence, use, transport, abandonment or disposal of which:
- 1.47.1. requires investigation, remediation, compensation, fine or penalty under any Applicable Law (including, without limitation, the Comprehensive Environmental Response Compensation and Liability Act, Superfund Amendment and Reauthorization Act, Resource Conservation Recovery Act, the Occupational Safety and Health Act and provisions with similar purposes in applicable foreign, state and local jurisdictions); or
 - 1.47.2. poses risks to human health, safety or the environment (including, without limitation, indoor, outdoor or orbital space environments) and is regulated under any Applicable Law.
- 1.48. “Emergency Service Number (ESN)” is a number assigned to the ALI and selective routing databases for all subscriber telephone numbers. The ESN designates a unique combination of fire, police and emergency medical service response agencies that serve the address location of each in-service telephone number.
- 1.49. “Exchange Message Record System (EMR)” refers to the exchanging telecommunications message information for billable, non-billable, sample, settlement and study data. EMR format is contained in BR-010-200-010 CRIS Exchange Message Record, published by Bellcore and which defines the industry standard for exchange message records.
- 1.50. “Enhanced Directory Assistance” refers to directory Assistance services, including but not limited to reverse search, talking yellow pages, and locator services.
- 1.51. “Expanded Interconnection Service (EIS)” is the collocation arrangement which Sprint provides in its designated wire centers.
- 1.52. “Grandfathered Service” means service which is no longer available for new customers and is limited to the current customer at their current locations with certain provisioning limitations, including but not limited to upgrade denials, feature adds/changes and responsible/billing party.
- 1.53. “FCC” means the Federal Communications Commission.
- 1.54. “Incumbent Local Exchange Carrier (ILEC)” means any local exchange carrier that was, as of February 8, 1996, deemed to be a member of the Exchange Carrier Association as set for the in 47 CFR § 69.601 (b) of the FCC’s regulations.
- 1.55. “Interexchange Carrier (IXC)” means a provider of interexchange telecommunications services.
- 1.56. “Interim Number Portability (INP)” is a service arrangement whereby subscribers who change local service providers may retain existing telephone numbers without impairment of quality, reliability, or convenience when remaining at their current location or changing their location within the geographic area served by the initial carrier’s serving

central office. Upon implementation of Local Number Portability, defined herein, INP services will be discontinued.

- 1.57. "Line Information Data Base (LIDB)" means a Service Control Point (SCP) database that provides for such functions as calling card validation for telephone line number cards issued by Sprint and other entities and validation for collect and billed-to-third services.
- 1.58. "Local Loop" refers to a transmission path between the main distribution frame [cross-connect], or its equivalent, in a Sprint Central Office or wire center, and up to the Network Interface Device at a customer's premises, to which CLEC is granted exclusive use. This includes, but is not limited to, two-wire and four-wire cooper analog voice-grade loops, two-wire and four-wire loops that are conditioned to transmit the digital signals needed to provide services such as ISDN and DS1-level signals.
- 1.59. "Local Number Portability (LNP)" means the ability of users of Telecommunications Services to retain, at the same Sprint served rate center, existing telecommunications numbers without impairment of quality, reliability, or convenience when switching from one telecommunications carrier to another.
- 1.60. "Local Service Request (LSR)" means an industry standard form or a mutually agreed upon change thereof, used by the Parties to add, establish, change or disconnect local services.
- 1.61. "Local Traffic" means traffic (excluding CMRS traffic) that is originated and terminated within Sprint's local calling area, or mandatory expanded area service (EAS) area, as defined by State commissions or, if not defined by State commissions, then as defined in existing Sprint tariffs.
- 1.62. "Master Street Address Guide (MSAG)" is a database defining the geographic area of an E911 service. It includes an alphabetical list of the street names, high-low house number ranges, community names, and emergency service numbers provided by the counties or their agents to Sprint.
- 1.63. "Multiple Exchange Carrier Access Billing (MECAB)" refers to the document prepared by the Billing Committee of the Alliance for Telecommunications Industry Solutions' (ATIS) Ordering and Billing Forum (OBF). The MECAB document contains the recommended guidelines for the billing of an access service provided to a customer by two or more providers or by one provider in two or more states within a single LATA.
- 1.64. "Multiple Exchange Carrier Ordering and Design (MECOD) Guidelines for Access Services - Industry Support Interface" refers to a document developed by the Ordering/Provisioning Committee of ATIS OBF. The MECOD document contains the recommended guidelines for processing orders for access service which is to be provided by two or more telecommunications carriers.
- 1.65. "North American Numbering Plan (NANP)" means the system or method of telephone numbering employed in the United States, Canada, and certain Caribbean countries. It denotes the three-digit Numbering Plan Area code and a seven digit telephone number made up of a three-digit Central Office code plus a four-digit station number.

- 1.66. “National Emergency Number Association (NENA)” is an association with a mission to foster the technological advancement, availability and implementation of 911 nationwide.
- 1.67. “Network Element” as defined in the Act.
- 1.68. “Numbering Plan Area (NPA)” (sometimes referred to as an area code) is the three-digit indicator which is designated by the first three digits of each 10-digit telephone number within the NANP. Each NPA contains 800 possible NXX Codes. There are two general categories of NPA, “Geographic NPAs” and “Non-Geographic NPAs.” A “Geographic NPA” is associated with a defined geographic area, and all telephone numbers bearing such NPA are associated with services provided within that geographic area. A “Non-Geographic NPA,” also known as a “Service Access Code (SAC Code)” is typically associated with a specialized telecommunications service which may be provided across multiple geographic NPA areas; 500, 800, 900, 700, and 888 are examples of Non-Geographic NPAs.
- 1.69. “NXX,” “NXX Code,” “NNX,” “COC,” “Central Office Code,” or “CO Code” is the three-digit switch entity indicator which is defined by the fourth, fifth and sixth digits of a 10-digit telephone number within NANP.
- 1.70. “OBF” means the Ordering and Billing Forum, which functions under the auspices of the Carrier Liaison Committee (CLC) of the Alliance for Telecommunications Industry Solutions (ATIS)
- 1.71. “Operator Systems” is the Network Element that provides operator and automated call handling with billing, special services, subscriber telephone listings, and optional call completion services.
- 1.72. “Operator Services” provides for:
 - 1.72.1. operator handling for call completion (e.g., collect calls);
 - 1.72.2. operator or automated assistance for billing after the subscriber has dialed the called number (e.g., credit card calls); and
 - 1.72.3. special services (e.g., BLV/BLI, Emergency Agency Call).
- 1.73. “Parity” means, subject to the availability, development and implementation of necessary industry standard Electronic Interfaces, the provision by Sprint of services, Network Elements, functionality or telephone numbering resources under this Agreement to CLEC, including provisioning and repair, at least equal in quality to those offered to Sprint, its Affiliates or any other entity that obtains such services, Network Elements, functionality or telephone numbering resources. Until the implementation of necessary Electronic Interfaces, Sprint shall provide such services, Network Elements, functionality or telephone numbering resources on a non-discriminatory basis to CLEC as it provides to its Affiliates or any other entity that obtains such services, Network Elements, functionality or telephone numbering resources.
- 1.74. “P.01 Transmission Grade Of Service (GOS)” means a trunk facility provisioning

- standard with the statistical probability of no more than one call in 100 blocked on initial attempt during the average busy hour.
- 1.75. "Parties" means, jointly, Sprint-Florida, Incorporated and Dakota Services Limited, and no other entity, affiliate, subsidiary or assign.
 - 1.76. "Party" means either Sprint-Florida, Incorporated or Dakota Services Limited, and no other entity, affiliate, subsidiary or assign.
 - 1.77. "Percent Local Usage (PLU)" is a calculation which represents the ratio of the local minutes to the sum of local and intraLATA toll minutes between exchange carriers sent over Local Interconnection Trunks. Directory assistance, BLV/BLVI, 900, and 976 transiting calls from other exchange carriers and switched access calls are not included in the calculation of PLU.
 - 1.78. "Point Of Interconnection (POI)" is a mutually agreed upon point of demarcation where the networks of Sprint and CLEC interconnect for the exchange of traffic.
 - 1.79. "Point of Presence (POP)" means an IXC's point of presence.
 - 1.80. "Proprietary Information" shall have the same meaning as Confidential Information.
 - 1.81. "Public Safety Answering Point (PSAP)" is the public safety communications center where 911 calls placed by the public for a specific geographic area will be answered.
 - 1.82. "Rate Center" means the geographic point and corresponding geographic area which are associated with one or more particular NPA-NXX codes which have been assigned to Sprint or CLEC for its provision of Basic Exchange Telecommunications Services. The "rate center point" is the finite geographic point identified by a specific V&H coordinate, which is used to measure distance-sensitive end user traffic to/from the particular NPA-NXX designations associated with the specific Rate Center. The "rate center area" is the exclusive geographic area identified as the area within which Sprint or CLEC will provide Basic Exchange Telecommunications Services bearing the particular NPA-NXX designations associated with the specific Rate Center. The Rate Center point must be located within the Rate Center area.
 - 1.83. "Recipient" means that party to this Agreement (a) to which Confidential Information has been disclosed by the other party or (b) who has obtained Confidential Information in the course of providing services under this Agreement.
 - 1.84. "Rebranding" occurs when CLEC purchases a wholesale service from Sprint when CLEC's brand is substituted for the Sprint brand.
 - 1.85. "Reseller" is a category of Local Exchange service providers who obtain dial tone and associated Telecommunications Services from another provider for resale to their end user subscribers.
 - 1.86. "Routing Point" means a location which Sprint or CLEC has designated on its own network as the homing (routing) point for traffic inbound to Basic Exchange Services provided by Sprint or CLEC which bear a certain NPA-NXX designation. The Routing

Point is employed to calculate mileage measurements for the distance-sensitive transport element charges of Switched Access Services. Pursuant to Bellcore Practice BR 795-100-100, the Routing Point may be an "End Office" location, or a "LEC Consortium Point of Interconnection." Pursuant to that same Bellcore Practice, examples of the latter shall be designated by a common language location identifier (CLLI) code with (x)KD in positions 9, 10, 11, where (x) may be any alphanumeric A-Z or 0-9. The above referenced Bellcore document refers to the Routing Point as the Rating Point. The Rating Point/Routing Point need not be the same as the Rate Center Point, nor must it be located within the Rate Center Area, but must be in the same LATA as the NPA-NXX.

- 1.87. "Small Exchange Carrier Access Billing (SECAB)" means the document prepared by the Billing Committee of the OBF. The SECAB document, published by ATIS as Special Report SR OPT-001856, contains the recommended guidelines for the billing of access and other connectivity services.
- 1.88. "Selective Routing" is a service which automatically routes an E911 call to the PSAP that has jurisdictional responsibility for the service address of the telephone that dialed 911, irrespective of telephone company exchange or wire center boundaries.
- 1.89. "Signaling Transfer Point (STP)" means a signaling point that performs message routing functions and provides information for the routing of messages between signaling points within or between CCIS networks. A STP transmits, receives and processes CCIS messages.
- 1.90. "Switch" means a Central Office Switch as defined in this Part A.
- 1.91. "Switched Access Detail Usage Data" means a category 1101XX record as defined in the EMR Bellcore Practice BR 010-200-010.
- 1.92. "Switched Exchange Access Service" means the offering of transmission or switching services to Telecommunications Carriers for the purpose of the origination or termination of Telephone Toll Service. Switched Exchange Access Services include: Feature Group A, Feature Group B, Feature Group D, 800/888 access and 900 access and their successor or similar Switched Exchange Access Services.
- 1.93. "Synchronous Optical Network (SONET)" is an optical interface standard that allows interworking of transmission products from multiple vendors (i.e., mid-span meets). The base rate is 51.84 MHps (OC-1/STS-1 and higher rates are direct multiples of the base rate up to 1.22 GHps).
- 1.94. "Tandem Office Switches", "Tandem", and "Tandem Switching" describe Class 4 switches which are used to connect and switch trunk circuits between and among end office switches and other tandems.
- 1.95. "Tariff" means a filing made at the state or federal level for the provision of a telecommunications service by a telecommunications carrier that provides for the terms, conditions and pricing of that service. Such filing may be required or voluntary and may or may not be specifically approved by the Commission or FCC.

- 1.96. “Technically Feasible” refers solely to technical or operational concerns, rather than economic, space, or site considerations.
- 1.97. “Telecommunications” as defined in the Act.
- 1.98. “Telecommunications Carrier” as defined in the Act.
- 1.99. “Telecommunication Services” means the offering of Telecommunications for a fee directly to the public, or to such classes of users as to be effectively available directly to the public, regardless of the facilities used.
- 1.100. “Thousands Block Of Numbers” shall mean 1000 or more consecutive numbers beginning and ending on a digit boundary, e.g., 949-1000 to 949-1999.
- 1.101. “Transit Service” means the delivery of Local or non-Local Traffic by Sprint or CLEC, that originated on one Party’s network, transited through the other Party’s network, and terminated to a third party Telecommunications Carrier’s network.
- 1.102. “Transit Traffic” means Local or non-Local traffic that originated on one Party’s network, transited through the other Party’s network, and terminated to a third party Telecommunications Carrier’s network.
- 1.103. “Trunk-Side” refers to a Central Office Switch connection that is capable of, and has been programmed to treat the circuit as, connecting to another switching entity or another central office switch. Trunk side connections offer those transmission and signaling features appropriate for the connection of switching entities, and cannot be used for the direct connection of ordinary telephone station sets.
- 1.104. “Voluntary Federal Subscriber Financial Assistance Programs” are government programs that subsidize the provision of Telecommunications Services to low-income subscribers, pursuant to requirements established by the appropriate state regulatory body.
- 1.105. “Wholesale Service” as defined in the Act.
- 1.106. “Wire Center” denotes a building or space within a building which serves as an aggregation point on a given carrier’s network, where transmission facilities and circuits are connected or switched. Wire center can also denote a building in which one or more central offices, used for the provision of Basic Exchange Services and access services, are located. However, for purposes of EIC service, Wire Center shall mean those points eligible for such connections as specified in the FCC Docket No. 91-141, and rules adopted pursuant thereto.
- 1.107. “xDSL” refers to a generic term for a new series of high speed transmission protocols, equipment, and services designed to operate over copper wire. This series includes but is not limited to ADSL, VDSL, SDSL, and others.

PART B – GENERAL TERMS AND CONDITIONS

1. SCOPE OF THIS AGREEMENT

- 1.1. This Agreement, including Parts A, B, and Attachments I through VIII, specifies the rights and obligations of each party with respect to the establishment, purchase, and sale of Local Interconnection, resale of Telecommunications Services and Unbundled Network Elements. Certain terms used in this Agreement shall have the meanings defined in PART A -- DEFINITIONS, or as otherwise elsewhere defined throughout this Agreement. Other terms used but not defined herein will have the meanings ascribed to them in the Act, in the FCC's, and in the Commission's Rules and Regulations. PART B sets forth the general terms and conditions governing this Agreement. The attachments set forth, among other things, descriptions of the services, pricing, technical and business requirements, and physical and network security requirements.

LIST OF ATTACHMENTS:

I.	Price Schedule
II.	Local Resale
III.	Network Elements
IV.	Interconnection
V.	Interim Number Portability
VI.	Local Number Portability
VII.	General Business Requirements
VIII.	Reporting Standards

- 1.2. Sprint shall not discontinue any interconnection arrangement, Telecommunications Service, or Network Element provided or required hereunder without providing CLEC thirty (30) days prior written notice of such discontinuation of such service, element or arrangement. Sprint agrees to cooperate with CLEC and/or the appropriate regulatory body with any transition resulting from such discontinuation of service and to minimize the impact to customers which may result from such discontinuance of service.
- 1.3. Sprint shall provide notice of network changes and upgrades in accordance with §§ 51.325 through 51.335 of Title 47 of the Code of Federal Regulations.
- 1.4. The services and facilities to be provided to CLEC by Sprint in satisfaction of this Agreement may be provided pursuant to Sprint tariffs and then current practices. Should there be a conflict between the terms of this Agreement and any such tariffs and practices, the terms of the tariff shall control to the extent allowed by law or Commission order.

2. REGULATORY APPROVALS

- 2.1. This Agreement, and any amendment or modification hereof, will be submitted to the Commission for approval in accordance with § 252 of the Act within thirty (30) days after

obtaining the last required Agreement signature. Sprint and CLEC shall use their best efforts to obtain approval of this Agreement by any regulatory body having jurisdiction over this Agreement. In the event any governmental authority or agency rejects any provision hereof, the Parties shall negotiate promptly and in good faith such revisions as may reasonably be required to achieve approval.

- 2.2. The Parties acknowledge that the respective rights and obligations of each Party as set forth in this Agreement are based on the texts of the Act and the rules and regulations promulgated thereunder by the FCC and the Commission as of the Effective Date (“Applicable Rules”). In the event of any amendment of the Act, any effective legislative action or any effective regulatory or judicial order, rule, regulation, arbitration award, dispute resolution procedures under this Agreement or other legal action purporting to apply the provisions of the Act to the Parties or in which the FCC or the Commission makes a generic determination that is generally applicable which revises, modifies or reverses the Applicable Rules (individually and collectively, Amended Rules), either Party may, by providing written notice to the other Party, require that the affected provisions of this Agreement be renegotiated in good faith and this Agreement shall be amended accordingly to reflect the pricing, terms and conditions of each such Amended Rules relating to any of the provisions in this Agreement.
- 2.3. Notwithstanding any other provision of this Agreement to the contrary § 2.2 hereof shall control. Any rates, terms or conditions thus developed or modified shall be substituted in place of those previously in effect and shall be deemed to have been effective under this Agreement as of the effective date established by the amended rules, whether such action was commenced before or after the Effective Date of this Agreement. Should the Parties be unable to reach agreement with respect to the applicability of such order or the resulting appropriate modifications to this Agreement, either party may invoke the Dispute Resolution provisions of this Agreement, it being the intent of the parties that this Agreement shall be brought into conformity with the then current obligations under the Act as determined by the amended rules.
- 2.4. Additional services, beyond those specified herein, requested by either party relating to the subject matter of this Agreement will be incorporated into this Agreement by written amendment hereto.

3. TERM AND TERMINATION

- 3.1. This Agreement shall be deemed effective upon the Effective Date, provided however that if CLEC has any outstanding past due obligations to Sprint, this Agreement will not be effective until such time as any past due obligations with Sprint are paid in full. No order or request for services under this Agreement shall be processed before the Effective Date, except as may otherwise be agreed in writing between the Parties, provided CLEC has established a customer account with Sprint and has completed the Implementation Plan described in Article 30 hereof.
- 3.2. Except as provided herein, Sprint and CLEC agree to provide service to each other on the terms defined in this Agreement for a period of 2 years ending January 1, 2001 (“End

Date”).

- 3.3. In the event that CLEC desires uninterrupted service under this Agreement during negotiations, CLEC shall provide to Sprint written notification appropriate under the Act, and if the Parties are actually in arbitration or mediation before the appropriate Commission or FCC prior to the End Date, this Agreement will continue in effect only until the issuance of an order approving the new Agreement, whether a final non-appealable order or not, by the Commission or FCC resolving the issues set forth in such arbitration or mediation request.
- 3.4. In the event of default, the non-defaulting Party may immediately terminate this Agreement in whole or in part. Default is defined to include:
 - 3.4.1. Either Party’s insolvency or initiation of bankruptcy or receivership proceedings by or against the Party; or
 - 3.4.2. Either Party’s material breach of any of the terms or conditions hereof, including the failure to make any undisputed payment when due provided that the non-defaulting Party so advises the defaulting Party in writing of the event of the alleged default and the defaulting Party does not remedy the alleged default within sixty (60) days after written notice thereof.
- 3.5. Termination of this Agreement for any cause shall not release either Party from any liability which at the time of termination has already accrued to the other Party or which thereafter may accrue in respect to any act or omission prior to termination or from any obligation which is expressly stated herein to survive termination.
- 3.6. In the event this agreement is terminated under § 3.4 Sprint may immediately discontinue processing orders for new service from CLEC and file with the Commission to terminate this agreement and reassign CLEC’s customers pursuant to the Commission’s guidelines for CLEC’s that abandon service.
- 3.7. Notwithstanding the above, should Sprint sell or trade substantially all the assets in an exchange or group of exchanges that Sprint uses to provide Telecommunications Services then Sprint may terminate this Agreement in whole or in part as to that particular exchange or group of exchanges upon sixty (60) days prior written notice.

4. POST TERMINATION INTERIM SERVICE ARRANGEMENTS

- 4.1. In the event that this Agreement expires under § 3.2, it is the intent of the Parties to provide in this Article for interim service arrangements between the Parties at the time of expiration so that service to end users will not be interrupted should a new agreement not be consummated prior to the End Date. Therefore, except in the case of termination as a result of either Party’s default under § 3.4, or for termination upon sale under § 3.7, for service made available under this Agreement and existing as of the End Date, the Parties agree that those services may continue uninterrupted at the request of either Party provided that:

- 4.1.1. a new agreement is voluntarily entered into by the Parties; or
- 4.1.2. service is provided under such standard terms and conditions or tariffs approved by and made generally available by the Commission, if they exist at the time of termination; or
- 4.1.3. CLEC elects to take service pursuant to the entire terms and conditions of an existing agreement between Sprint and another CLEC for the remaining term of that agreement. If neither § 4.1.1 or § 4.1.2 are in effect, and CLEC does not designate an agreement under this subsection, Sprint may designate such agreement.

5. CHARGES AND PAYMENT

- 5.1. In consideration of the services provided by Sprint under this Agreement, CLEC shall pay the charges set forth in Attachment I subject to the provisions of §§ 2.2 and 2.3 hereof. The billing and payment procedures for charges incurred by CLEC hereunder are set forth in Attachment VIII.
- 5.2. In addition to any other applicable charges under this Article 5 and Attachment I, if CLEC purchases unbundled Local Switching elements, CLEC shall pay Sprint for intrastate toll minutes of use traversing such unbundled Local Switching elements, intrastate carrier common line and interconnection charges as outlined on Attachment I hereto and any explicit intrastate universal service mechanism based on access charges.
- 5.3. Subject to the terms of this Agreement, the Parties shall pay invoices by the due date shown on the invoice. For invoices not paid when due, late payment charges will be assessed under § 5.5. If the payment due date is a Saturday, Sunday or a designated bank holiday, payment shall be made the next business day.
- 5.4. Billed amounts for which written, itemized disputes or claims have been filed are not due for payment until such disputes or claims have been resolved in accordance with the provisions governing dispute resolution of this Agreement. Itemized, written disputes must be filed with Sprint's National Exchange Access Center ("NEAC") no later than the due date of the related invoice. A copy of the dispute must be sent with the remittance of the remainder of the invoice.
- 5.5. Sprint will assess late payment charges to CLEC equal to the lesser of one and one-half percent (1.5%) per month or the maximum rate allowed by law for commercial transactions, of the balance due, until the amount due is paid in full.
- 5.6. In addition to late payment charges, Sprint will use the following collection procedures in connection with CLEC's past due amounts.
 - 5.6.1. First, the late payment charge described in § 5.5 above will be added to accounts that are not paid within a thirty (30) day period.
 - 5.6.2. Second, a notice will be sent to CLEC on day 31 stating that unless full payment is received within the next thirty (30) days Sprint will suspend processing new

orders.

5.6.3. Third, if the CLEC account remains delinquent on day 61 Sprint will send a second notice to CLEC stating that Sprint has suspended processing new orders and unless payment is received by day 90, service for all CLEC end user customers will be suspended.

5.6.4. Fourth, should the CLEC account remain outstanding on day 91 Sprint will deny service and send a letter to CLEC stating that their service has been suspended for non-payment.

5.7. Sprint reserves the right to periodically revise its collection procedure to conform to then current business practices and regulations. Sprint will provide timely notification to CLEC of changes to its collection practice in a manner consistent with its own customer notification.

6. AUDITS AND EXAMINATIONS

6.1. As used herein "Audit" shall mean a comprehensive review of services performed under this Agreement; "Examination" shall mean an inquiry into a specific element of or process related to services performed under this Agreement billed amounts. Either party (the "Requesting Party") may perform one (1) Audit per twelve (12) month period commencing with the Effective Date. The Audit period will include no more than the preceding twelve (12) month period as of the date of the Audit request. The Requesting Party may perform Examinations as it deems necessary, with the assistance of the other Party, which will not be unreasonably withheld.

6.2. Upon thirty (30) days written notice by the Requesting Party to Audited Party, Requesting Party shall have the right through its authorized representative to make an Audit or Examination, during normal business hours, of any records, accounts and processes which contain information bearing upon the provision of the services provided and performance standards agreed to under this Agreement. Within the above-described thirty (30) day period, the Parties shall reasonably agree upon the scope of the Audit or Examination, the documents and processes to be reviewed, and the time, place and manner in which the Audit or Examination shall be performed. Audited Party agrees to provide Audit or Examination support, including appropriate access to and use of Audited Party's facilities (e.g.: conference rooms, telephones, copying machines).

6.3. Each party shall bear its own expenses in connection with the conduct of the Audit or Examination. The reasonable cost of special data extraction required by the Requesting Party to conduct the Audit or Examination will be paid for by the Requesting Party. For purposes of this § 6.3, a "Special Data Extraction" shall mean the creation of an output record or informational report (from existing data files) that is not created in the normal course of business. If any program is developed to Requesting Party's specifications and at Requesting Party's expense, Requesting Party shall specify at the time of request whether the program is to be retained by Audited party for reuse for any subsequent Audit or Examination.

- 6.4. Adjustments based on the audit findings may be applied to the twelve (12) month period included in the audit. Adjustments, credits or payments shall be made and any corrective action shall commence within thirty (30) days from receipt of requesting Party's receipt of the final audit report to compensate for any errors or omissions which are disclosed by such Audit or Examination and are agreed to by the Parties. Interest shall be calculated in accordance with § 5.5 herein.
- 6.5. Neither such right to examine and audit nor the right to receive an adjustment shall be affected by any statement to the contrary appearing on checks or otherwise, unless such statement expressly waiving such right appears in writing, is signed by the authorized representative of the party having such right and is delivered to the other party in a manner sanctioned by this Agreement.
- 6.6. This Article 6 shall survive expiration or termination of this Agreement for a period of one (1) year after expiration or termination of this Agreement.

7. INTELLECTUAL PROPERTY RIGHTS

- 7.1. Any intellectual property which originates from or is developed by a Party shall remain in the exclusive ownership of that Party. Except for a limited license to use patents or copyrights to the extent necessary for the Parties to use any facilities or equipment (including software) or to receive any service solely as provided under this Agreement, no license in patent, copyright, trademark or trade secret, or other proprietary or intellectual property right now or hereafter owned, controlled or licensable by a Party, is granted to the other Party or shall be implied or arise by estoppel.
- 7.2. Neither Party shall have any obligation to defend, indemnify or hold harmless, or acquire any license or right for the benefit of, or owe any other obligation or any liability to, the other Party based on or arising from any claim, demand, or proceeding by any third party alleging or asserting that the use of any circuit, apparatus or system, or the use of any software, or the performance of any service or method, or the provision or use of any facilities by either party under this Agreement, constitutes direct or contributory infringement, or misuse or misappropriation of any patent, copyright, trademark, trade secret, or any other proprietary or intellectual property right of any third party.
- 7.3. Following notice of an infringement claim against Sprint based on the use by CLEC of a service or facility, CLEC shall at CLEC's expense, procure from the appropriate third parties the right to continue to use the alleged infringing intellectual property or if CLEC fails to do so, Sprint may charge CLEC for such costs as permitted under a Commission order.

8. LIMITATION OF LIABILITY

- 8.1. Except as otherwise set forth in this Agreement, neither Party shall be responsible to the other for any indirect, special, consequential or punitive damages, including (without limitation) damages for loss of anticipated profits or revenue or other economic loss in connection with or arising from anything said, omitted, or done hereunder (collectively

“Consequential Damages”), whether arising in contract or tort, provided that the foregoing shall not limit a Party’s obligation under Article 9 to indemnify, defend, and hold the other party harmless against amounts payable to third parties. Notwithstanding the foregoing, in no event shall Sprint’s liability to CLEC for a service outage exceed an amount equal to the proportionate charge for the service(s) or unbundled element(s) provided for the period during which the service was affected.

9. INDEMNIFICATION

- 9.1. Each Party agrees to indemnify and hold harmless the other Party from and against claims for damage to tangible personal or real property and/or personal injuries arising out of the negligence or willful act or omission of the indemnifying Party or its agents, servants, employees, contractors or representatives. To the extent not prohibited by law, each Party shall defend, indemnify, and hold the other Party harmless against any loss to a third party arising out of the negligence or willful misconduct by such indemnifying Party, its agents, or contractors in connection with its provision of service or functions under this Agreement. Notwithstanding the above, in the case of any loss alleged or damage claim made by a Customer of either Party in connection with the service provided by that Party, and which allegation or claim relates in some way to a service provided under this Agreement, the Party whose customer alleged such loss shall indemnify the other Party and hold it harmless against any or all of such loss alleged by each and every Customer which arises out of the negligence or willful misconduct of the indemnifying Party. The indemnifying Party under this Article agrees to defend any suit brought against the other Party either individually or jointly with the indemnified Party for any such loss, injury, liability, claim or demand. The indemnified Party agrees to notify the other Party promptly, in writing, of any written claims, lawsuits, or demands for which it is claimed that the indemnifying Party is responsible under this Article and to cooperate in every reasonable way to facilitate defense or settlement of claims. The indemnifying Party shall have complete control over defense of the case and over the terms of any proposed settlement or compromise thereof. The indemnifying Party shall not be liable under this Article for settlement by the indemnified Party of any claim, lawsuit, or demand, if the indemnifying Party has not approved the settlement in advance, unless the indemnifying Party has had the defense of the claim, lawsuit, or demand tendered to it in writing and has failed to assume such defense. In the event of such failure to assume defense, the indemnifying Party shall be liable for any reasonable settlement made by the indemnified Party without approval of the indemnifying Party.
- 9.2. Each Party agrees to indemnify and hold harmless the other Party from all claims and damages arising from the Indemnifying Party’s discontinuance of service to one of the Indemnifying Party’s subscribers for nonpayment.
- 9.3. When the lines or services of other companies and Carriers are used in establishing connections to and/or from points not reached by a Party’s lines, neither Party shall be liable for any act or omission of the other companies or Carriers.
- 9.4. In addition to its indemnity obligations hereunder, each Party shall, to the extent allowed by law or Commission Order, provide, in its tariffs and contracts with its subscribers that

relate to any Telecommunications Services or Network Element provided or contemplated under this Agreement, that in no case shall such Party or any of its agents, contractors or others retained by such Party be liable to any subscriber or third party for (i) any loss relating to or arising out of this Agreement, whether in contract or tort, that exceeds the amount such Party would have charged the applicable subscriber for the service(s) or function(s) that gave rise to such loss, and (ii) Consequential Damages (as defined in Article 8 above).

10. BRANDING

- 10.1. CLEC shall provide the exclusive interface to CLEC subscribers, except as CLEC shall otherwise specify for the reporting of trouble or other matters identified by CLEC for which Sprint may directly communicate with CLEC subscribers. In those instances where CLEC requests that Sprint personnel interface with CLEC subscribers, such Sprint personnel shall inform the CLEC subscribers that they are representing CLEC, or such brand as CLEC may specify.
- 10.2. Other business materials furnished by Sprint to CLEC subscribers shall bear no corporate name, logo, trademark or tradename.
- 10.3. Except as specifically permitted by a Party, in no event shall either Party provide information to the other Party's subscribers about the other Party or the other Party's products or services.
- 10.4. Sprint shall share pertinent details of Sprint's training approaches related to branding with CLEC to be used by Sprint to assure that Sprint meets the branding requirements agreed to by the Parties.
- 10.5. This Article 10 shall not confer on either Party any rights to the service marks, trademarks and/or trade names owned by or used in connection with services by the other Party, except as expressly permitted in writing by the other Party.

11. CONFIDENTIALITY AND PUBLICITY

- 11.1. All information which is disclosed by one party ("Disclosing Party") to the other ("Recipient") in connection with this Agreement, or acquired in the course of performance of this Agreement, shall be deemed confidential and proprietary to the Disclosing Party and subject to this Agreement, such information including but not limited to, orders for services, usage information in any form, and CPNI as that term is defined by the Act and the rules and regulations of the FCC ("Confidential and/or Proprietary Information").
- 11.2. During the term of this Agreement, and for a period of one (1) year thereafter, Recipient shall (i) use it only for the purpose of performing under this Agreement, (ii) hold it in confidence and disclose it only to employees or agents who have a need to know it in order to perform under this Agreement, and (iii) safeguard it from unauthorized use or Disclosure using no less than the degree of care with which Recipient safeguards its own Confidential Information.

- 11.3. Recipient shall have no obligation to safeguard Confidential Information (i) which was in the Recipient's possession free of restriction prior to its receipt from Disclosing Party, (ii) which becomes publicly known or available through no breach of this Agreement by Recipient, (iii) which is rightfully acquired by Recipient free of restrictions on its Disclosure, or (iv) which is independently developed by personnel of Recipient to whom the Disclosing Party's Confidential Information had not been previously disclosed. Recipient may disclose Confidential Information if required by law, a court, or governmental agency, provided that Disclosing Party has been notified of the requirement promptly after Recipient becomes aware of the requirement, and provided that Recipient undertakes all lawful measures to avoid disclosing such information until Disclosing Party has had reasonable time to obtain a protective order. Recipient agrees to comply with any protective order that covers the Confidential Information to be disclosed.
- 11.4. Each Party agrees that Disclosing Party would be irreparably injured by a breach of this Article 11 by Recipient or its representatives and that Disclosing Party shall be entitled to seek equitable relief, including injunctive relief and specific performance, in the event of any breach of this Article 11. Such remedies shall not be exclusive, but shall be in addition to all other remedies available at law or in equity.
- 11.5. Unless otherwise agreed, neither Party shall publish or use the other Party's logo, trademark, service mark, name, language, pictures, symbols or words from which the other Party's name may reasonably be inferred or implied in any product, service, advertisement, promotion, or any other publicity matter, except that nothing in this paragraph shall prohibit a Party from engaging in valid comparative advertising. This § 11.5 shall confer no rights on a Party to the service marks, trademarks and trade names owned or used in connection with services by the other Party or its Affiliates, except as expressly permitted by the other Party.
- 11.6. Neither Party shall produce, publish, or distribute any press release nor other publicity referring to the other Party or its Affiliates, or referring to this Agreement, without the prior written approval of the other Party. Each party shall obtain the other Party's prior approval before discussing this Agreement in any press or media interviews. In no event shall either Party mischaracterize the contents of this Agreement in any public statement or in any representation to a governmental entity or member thereof.
- 11.7. Except as otherwise expressly provided in this Article 11, nothing herein shall be construed as limiting the rights of either Party with respect to its customer information under any applicable law, including without limitation § 222 of the Act.

12. DISCLAIMER OF WARRANTIES

- 12.1. EXCEPT AS SPECIFICALLY PROVIDED ELSEWHERE IN THIS AGREEMENT TO THE CONTRARY, NEITHER PARTY MAKES ANY REPRESENTATIONS OR WARRANTIES, EXPRESS OR IMPLIED, WITH RESPECT TO QUALITY, FUNCTIONALITY OR CHARACTERISTICS OF THE SERVICES PROVIDED PURSUANT TO THIS AGREEMENT, INCLUDING, BUT NOT LIMITED TO, IMPLIED WARRANTIES OF MERCHANTABILITY AND/OR FITNESS FOR A

PARTICULAR PURPOSE. NO REPRESENTATION OR STATEMENT MADE BY EITHER PARTY OR ANY OF ITS AGENTS OR EMPLOYEES, ORAL OR WRITTEN, INCLUDING, BUT NOT LIMITED TO, ANY SPECIFICATIONS, DESCRIPTIONS OR STATEMENTS PROVIDED OR MADE SHALL BE BINDING UPON EITHER PARTY AS A WARRANTY.

13. ASSIGNMENT AND SUBCONTRACT

- 13.1. If any Affiliate of either Party succeeds to that portion of the business of such Party that is responsible for, or entitled to, any rights, obligations, duties, or other interests under this Agreement, such Affiliate may succeed to those rights, obligations, duties, and interest of such Party under this Agreement. In the event of any such succession hereunder, the successor shall expressly undertake in writing to the other Party the performance and liability for those obligations and duties as to which it is succeeding a Party to this Agreement. Thereafter, the successor Party shall be deemed Carrier or Sprint and the original Party shall be relieved of such obligations and duties, except for matters arising out of events occurring prior to the date of such undertaking.
- 13.2. Except as herein before provided, and except for an assignment confined solely to moneys due or to become due, any assignment of this Agreement or of the work to be performed, in whole or in part, or of any other interest of a Party hereunder, without the other Party's written consent, which consent shall not be unreasonably withheld or delayed, shall be void. It is expressly agreed that any assignment of monies shall be void to the extent that it attempts to impose additional obligations other than the payment of such moneys on the other Party or the assignee additional to the payment of such moneys.

14. GOVERNING LAW

- 14.1. This Agreement shall be governed by and construed in accordance with the Act, orders of the Commission, and the FCC's Rules and Regulations, except insofar as state law may control any aspect of this Agreement, in which case the domestic laws of the State of Florida, without regard to its conflicts of laws principles, shall govern. In all other respects, in the event of a conflict between the provisions of this Agreement and the Act, the provisions of the Act shall govern.

15. RELATIONSHIP OF PARTIES

- 15.1. It is the intention of the Parties that each Party shall be an independent contractor and nothing contained herein shall constitute the Parties as joint venturers, partners, employees or agents of one another, and neither Party shall have the right or power to bind or obligate the other.

16. NO THIRD PARTY BENEFICIARIES

- 16.1. The provisions of this Agreement are for the benefit of the Parties hereto and not for any other person, and this Agreement shall not provide any person not a party hereto with any remedy, claim, liability, reimbursement, right of action, or other right in excess of those

existing without reference hereto. This shall not be construed to prevent Carrier from providing its Telecommunications Services to other carriers.

17. NOTICES

17.1. Except as otherwise provided herein, all notices or other communication hereunder shall be deemed to have been duly given when made in writing and delivered in person or deposited in the United States mail, certified mail, postage prepaid, return receipt requested and addressed as follows:

If to Sprint:	Director Local Carrier Markets Sprint 2330 Shawnee Mission Pkwy Mailstop KSFRWB0301 Fairway, KS 66205	If to CLEC:	Ted Lasser Dakota Services Limited 20825 Swenson Dr., Suite 150 Waukesha, WI 53186
with a copy to:	Field Service Manager Sprint 900 Springmill St. P.O. Box 3555 Mansfield, OH 44907	With a Copy to:	

17.2. If personal delivery is selected to give notice, a receipt of such delivery shall be obtained. The address to which notices or communications may be given to either party may be changed by written notice given by such Party to the other pursuant to this Article 17.

18. WAIVERS

- 18.1. No waiver of any provisions of this Agreement and no consent to any default under this Agreement shall be effective unless the same shall be in writing and properly executed by or on behalf of the Party against whom such waiver or consent is claimed.
- 18.2. No course of dealing or failure of any Party to strictly enforce any term, right, or condition of this Agreement in any instance shall be construed as a general waiver or relinquishment of such term, right or condition.
- 18.3. Waiver by either party of any default by the other Party shall not be deemed a waiver of any other default.

19. SURVIVAL

19.1. Termination of this Agreement, or any part hereof, for any cause shall not release either

Party from any liability which at the time of termination had already accrued to the other Party or which thereafter accrues in any respect to any act or omission occurring prior to the termination or from an obligation which is expressly stated in this Agreement to survive termination including but not limited to §§ 5, 6, 7, 8, 11, 16, 18, 21.

20. FORCE MAJEURE

20.1. Neither Party shall be held liable for any delay or failure in performance of any part of this Agreement from any cause beyond its control and without its fault or negligence, such as acts of God, acts of civil or military authority, embargoes, epidemics, war, terrorist acts, riots, insurrections, fires, explosions, earthquakes, nuclear accidents, floods, power blackouts, strikes, work stoppage affecting a supplier or unusually severe weather. No delay or other failure to perform shall be excused pursuant to this Article 20 unless delay or failure and consequences thereof are beyond the control and without the fault or negligence of the Party claiming excusable delay or other failure to perform. In the event of any such excused delay in the performance of a Party's obligation(s) under this Agreement, the due date for the performance of the original obligation(s) shall be extended by a term equal to the time lost by reason of the delay. In the event of such delay, the delaying Party shall perform its obligations at a performance level no less than that which it uses for its own operations. In the event of such performance delay or failure by Sprint, Sprint agrees to resume performance in a nondiscriminatory manner and not favor its own provision of Telecommunications Services above that of CLEC.

21. DISPUTE RESOLUTION

21.1. The Parties recognize and agree that the Commission has continuing jurisdiction to implement and enforce all terms and conditions of this Agreement. Accordingly, the Parties agree that any dispute arising out of or relating to this Agreement that the Parties themselves cannot resolve may be submitted to the Commission for resolution. The Parties agree to seek expedited resolution by the Commission, and shall request that resolution occur in no event later than sixty (60) days from the date of submission of such dispute. If the Commission appoints an expert(s) or other facilitator(s) to assist in its decision making, each party shall pay half of the fees and expenses so incurred. During the Commission proceeding each Party shall continue to perform its obligations under this Agreement provided, however, that neither Party shall be required to act in any unlawful fashion. This provision shall not preclude the Parties from seeking relief available in any other forum.

21.2. If any portion of an amount due to a Party ("the Billing Party") under this Agreement is subject to a bona fide dispute between the Parties, the Party billed (the "Non-Paying Party") shall within thirty (30) days of its receipt of the invoice containing such disputed amount give written notice to the Billing Party at the address(es) indicated in Article 17 herein of the amounts it disputes ("Disputed Amounts") and include in such notice the specific details and reasons for disputing each item. The Non-Paying Party shall pay when due all undisputed amounts to the Billing Party, and shall include a copy of the dispute with the payment of the undisputed amounts. The balance of the Disputed

Amount, after the necessary adjustments have been made for the disputed amounts found in CLEC's favor, shall be paid with late charges, if appropriate, upon final determination of such dispute.

- 21.3. If the Parties are unable to resolve the issues related to the Disputed Amounts in the normal course of business within thirty (30) days after delivery to the Billing Party of notice of the Disputed Amounts, each of the Parties shall appoint a designated representative that has authority to settle the dispute and that is at a higher level of management than the persons with direct responsibility for administration of this Agreement. The designated representatives shall meet as often as they reasonably deem necessary in order to discuss the dispute and negotiate in good faith in an effort to resolve such dispute. The specific format for such discussions will be left to the discretion of the designated representatives, however all reasonable requests for relevant information made by one Party to the other Party shall be honored.
- 21.4. If the Parties are unable to resolve issues related to the Disputed Amounts within thirty (30) days after the Parties' appointment of designated representatives pursuant to § 21.3, then either Party may file a complaint with the Commission to resolve such issues or proceed with any other remedy pursuant to law or equity. The Commission may direct payment of any or all funds plus applicable late charges to be paid to either Party.

22. COOPERATION ON FRAUD

- 22.1. The Parties agree that they shall cooperate with one another to investigate, minimize and take corrective action in cases of fraud. The Parties' fraud minimization procedures are to be cost effective and implemented so as not to unduly burden or harm one party as compared to the other.

23. TAXES

- 23.1. Any Federal, state or local excise, license, sales, use, or other taxes or tax-like charges (excluding any taxes levied on income) resulting from the performance of this Agreement shall be borne by the Party upon which the obligation for payment is imposed under applicable law, even if the obligation to collect and remit such taxes is placed upon the other Party. Any such taxes shall be shown as separate items on applicable billing documents between the Parties. The Party obligated to collect and remit taxes shall do so unless the other Party provides such Party with the required evidence of exemption. The Party so obligated to pay any such taxes may contest the same in good faith, at its own expense, and shall be entitled to the benefit of any refund or recovery, provided that such party shall not permit any lien to exist on any asset of the other party by reason of the contest. The Party obligated to collect and remit taxes shall cooperate fully in any such contest by the other Party by providing records, testimony and such additional information or assistance as may reasonably be necessary to pursue the contest.

24. AMENDMENTS AND MODIFICATIONS

- 24.1. No provision of this Agreement shall be deemed waived, amended or modified by either

party unless such a waiver, amendment or modification is in writing, dated, and signed by both Parties.

25. SEVERABILITY

25.1. Subject to Part B, Article 2, if any part of this Agreement is held to be invalid for any reason, such invalidity will affect only the portion of this Agreement which is invalid. In all other respects this Agreement will stand as if such invalid provision had not been a part thereof, and the remainder of the Agreement shall remain in full force and effect.

26. HEADINGS NOT CONTROLLING

26.1. The headings and numbering of Articles, Sections, Parts and Attachments in this Agreement are for convenience only and shall not be construed to define or limit any of the terms herein or affect the meaning or interpretation of this Agreement.

27. ENTIRE AGREEMENT

27.1. This Agreement, including all Parts and Attachments and subordinate documents attached hereto or referenced herein, all of which are hereby incorporated by reference herein, constitute the entire matter thereof, and supersede all prior oral or written agreements, representations, statements, negotiations, understandings, proposals, and undertakings with respect to the subject matter thereof.

28. COUNTERPARTS

28.1. This Agreement may be executed in counterparts. Each counterpart shall be considered an original and such counterparts shall together constitute one and the same instrument.

29. SUCCESSORS AND ASSIGNS

29.1. This Agreement shall be binding upon, and inure to the benefit of, the Parties hereto and their respective successors and permitted assigns.

30. IMPLEMENTATION PLAN

30.1. This Agreement sets forth the overall standards of performance for services, processes, and systems capabilities that the Parties will provide to each other, and the intervals at which those services, processes and capabilities will be provided. The Parties understand that the arrangements and provision of services described in this Agreement shall require technical and operational coordination between the Parties. Accordingly, the Parties agree to form a team (the "Implementation Team") that shall develop and identify those processes, guidelines, specifications, standards and additional terms and conditions necessary to support the terms of this Agreement. Each Party shall designate, in writing, no more than four (4) persons to be permanent members of the Implementation Team; provided that either Party may include in meetings or activities such technical specialists or other individuals as may be reasonably required to address a specific task, matter or

subject. Each Party may replace its representatives by delivering written notice thereof to the other Party.

30.2. The agreements reached by the Implementation Team shall be documented in an operations manual (the "Implementation Plan") within one hundred-twenty (120) days of both Parties having designated members of the Implementation Team. The Implementation Plan shall address the following matters, and may include any other matters agreed upon by the Implementation Team:

- 30.2.1. the respective duties and responsibilities of the Parties with respect to the administration and maintenance of the interconnections (including signaling) specified in Attachment 3 and the trunk groups specified in Attachment 4 and, including standards and procedures for notification and discoveries of trunk disconnects;
- 30.2.2. disaster recovery and escalation provisions;
- 30.2.3. access to Operations Support Systems functions provided hereunder, including gateways and interfaces;
- 30.2.4. escalation procedures for ordering, provisioning, billing, and maintenance;
- 30.2.5. single points of contact for ordering, provisioning, billing, and maintenance;
- 30.2.6. service ordering and provisioning procedures, including provision of the trunks and facilities;
- 30.2.7. provisioning and maintenance support;
- 30.2.8. conditioning and provisioning of collocation space and maintenance of Virtually Collocated equipment;
- 30.2.9. procedures and processes for Directories and Directory Listings;
- 30.2.10. billing processes and procedures;
- 30.2.11. network planning components including time intervals;
- 30.2.12. joint systems readiness and operational readiness plans;
- 30.2.13. appropriate testing of services, equipment, facilities and Network Elements;
- 30.2.14. monitoring of inter-company operational processes;
- 30.2.15. procedures for coordination of local PIC changes and processing;
- 30.2.16. physical and network security concerns; and
- 30.2.17. such other matters specifically referenced in this Agreement that are to be agreed upon by the Implementation Team and/or contained in the Implementation Plan.

30.3. The Implementation Plan may be amended from time to time by the Implementation Team, as the team deems appropriate. Unanimous written consent of the permanent members of the Implementation Team shall be required for any action of the Implementation Team. If the Implementation Team is unable to act, the existing provisions of the Implementation Plan shall remain in full force and effect.

31. FEDERAL JURISDICTIONAL AREAS

31.1. CLEC understands and agrees that this agreement serves as actual notice that Sprint and its Affiliates have entered into a binding contract to provide exclusive telecommunications services for the Army and Air Force Exchange Service (“AAFES”) during the term of this agreement. The AAFES contract specifies, among other things, that Sprint shall provide all telecommunications services to officer and enlisted temporary living facilities (commonly named Bachelor Officer Quarters and Bachelor Enlisted Quarters) and to all unaccompanied enlisted personnel barracks on United States Army bases. CLEC agrees it will not market to or attempt to secure any customer located in an area governed by this exclusive telecommunications service provider contract.



IN WITNESS WHEREOF, each of the Parties has caused this Agreement to be executed by its duly authorized representatives.

"Sprint"

"CLEC"

United Telephone Company of the
Northwest

Dakota Services Limited

By:

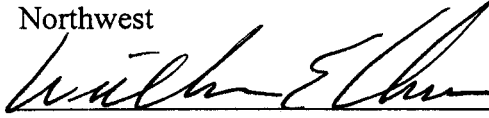

By:

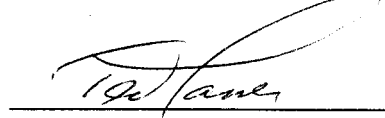

Name
(typed):

William E. Cheek

Name
(typed):

Ted Lasser

Title:

Vice President- Sales and Account
Management

Title:

President and CEO

Date:

2/15/99

Date:

1/17/99

ATTACHMENT I
GENERAL PRINCIPLES

1. PRICE SCHEDULE

- 1.1. Subject to the provisions of Part B, Article 2 of this Agreement, all rates provided under this Agreement shall remain in effect for the term of this Agreement.

2. LOCAL SERVICE RESALE

- 2.1. The rates that CLEC shall pay to Sprint for Local Resale are as set forth in Table 1 of this Attachment and shall be applied consistent with the provisions of Attachment II of this Agreement.

3. INTERCONNECTION AND RECIPROCAL COMPENSATION

- 3.1. The rates to be charged for the exchange of Local Traffic are set forth in Table 1 of this Attachment and shall be applied consistent with the provisions of Attachment IV of this Agreement.
- 3.2. Compensation for the termination of toll traffic and the origination of 800 traffic between the interconnecting parties shall be based on the applicable access charges in accordance with FCC and Commission Rules and Regulations and consistent with the provisions of Attachment IV of this Agreement.
- 3.3. INP is available in all Sprint service areas where LNP is not available. Once LNP is available, all INP arrangements will be converted to LNP. Where INP is available and a toll call is completed through Sprint's INP arrangement (e.g., remote call forwarding) to CLEC's subscriber, CLEC shall be entitled to applicable access charges in accordance with the FCC and Commission Rules and Regulations. If a national standard billing method has not been developed for a CLEC to directly bill a carrier access for a toll call that has been completed using interim number portability, then the blended rate per line method described in § 3.3.1 herein will be used.
- 3.3.1. The Parties will jointly determine the amount of traffic that will be considered INP'ed traffic for compensation purposes. The porting party shall charge the porting party on a per line basis using an average of Sprint's per line minutes of use and Sprint's access rates in lieu of any other compensation charges for terminating such traffic. The traffic that is not identified as INP'ed will be compensated as local interconnection as set forth in § 3.1.
- 3.3.2. For compensation of the INP Local Traffic, the Parties shall jointly develop a process which will allow compensation for INP'ed traffic to be based on the initial origination point and final terminated point of the INP'ed call. The full reciprocal compensation rate, as listed in the Pricing Schedule, shall apply for Local Traffic, and full switched access charges, as listed in applicable tariffs, shall apply for intraLATA and interLATA. All three sets of rates will be weighted

together based on the agreed minutes of use patterns to establish a single rate per INP line.

3.3.3. CLEC shall pay a transit rate, comprised of the transport and tandem rate elements, as set forth in Table 1 of this Attachment when CLEC uses a Sprint access tandem to terminate a local call to a third party LEC or another CLEC. Sprint shall pay CLEC a transit rate equal to the Sprint rate referenced above when Sprint uses a CLEC switch to terminate a local call to a third party LEC or another CLEC.

3.4. To receive reciprocal compensation for local calls, the call must both originate and terminate within the Sprint's tariffed local calling area, including mandatory EAS areas. Hyperion will identify the Percent Local Usage (PLU) factor on each interconnection order to identify the traffic that will be considered as local for reciprocal compensation purposes. Sprint may request Hyperion's traffic study documentation of the PLU at any time to verify the factor, and may compare the documentation to studies developed by Sprint. Should the documentation indicate that the factor should be changed by Sprint, the Parties agree that any changes will only be retroactive to traffic for the previous 90 days. For non-local traffic, the Parties agree to exchange traffic and to compensate one another based on the rates and elements included in each Party's access tariffs.

4. UNBUNDLED NETWORK ELEMENTS

4.1. The charges that CLEC shall pay to Sprint for Unbundled Network Elements are set forth in Table 1 of this Attachment I.

RESALE DISCOUNTS			
Element	Source	Percentage	NRC
Other than Operator/DA		19.40%	
Op Assist/DA		12.10%	
USAGE FEE CHARGES			
Message Provisioning, per message		\$0.005	
Data Transmission, per message		\$0.002	
Tape Charge, per tape		\$50.00	
Element	Source	Percentage	NRC
Service Order NRC			\$25.15
Service Order Listing Only			\$20.82
Central Office Interconnection Charge			\$10.27
Trip Charge			\$18.41
Outside Plant Interconnection (2-W)			\$59.75
Outside Plant Interconnection (4-W)			\$74.72
NID Installation Charge			\$37.36
NID Connection Charge			\$18.68
Testing			\$1.42

Loop Rework Charge (2-W)			\$37.38
Loop Rework Charge (4-W)			\$62.41
Trouble Isolation and Testing			\$66.58
OSS Service Charge		\$1.77	
Cancellation Charges			
New Unbundled Network Element (s)		ICB	ICB
New Point(s) of Interconnection		ICB	ICB
Presubscription, per telephone service line or trunk			
To change intralata toll carrier or interlata carrier			\$4.80
To change both intralata toll carrier and interlata carrier			
if same carrier			\$4.80
- if different carriers			\$6.24
Disputed Transfer			
Per residence line or trunk			\$50.00
Per Business line or trunk			\$60.00
NP			
1 Line		\$0.79	See NRC Section
2 Line		\$0.95	See NRC Section
SmartJack		\$12.37	See NRC Section
CCP			
Analog 2-wire	Band 1	\$10.78	See NRC Section
	Band 2	\$15.41	See NRC Section
	Band 3	\$20.54	See NRC Section
	Band 4	\$27.09	See NRC Section
	Band 5	\$39.66	See NRC Section
	Band 6	\$74.05	See NRC Section
Analog 4-wire	Band 1	\$18.80	See NRC Section
	Band 2	\$26.88	See NRC Section
	Band 3	\$35.85	See NRC Section
	Band 4	\$47.24	See NRC Section
	Band 5	\$69.17	See NRC Section
	Band 6	\$129.13	See NRC Section
DS0 2 Wire Digital Data Loop or Interconnection ADSL/ISDN-BRI			
	Band 1	\$11.65	\$89.14
	Band 2	\$16.65	\$89.14
	Band 3	\$22.20	\$89.14
	Band 4	\$29.26	\$89.14
	Band 5	\$42.84	\$89.14
	Band 6	\$79.98	\$89.14
DS0 4 Wire Digital Data Loop 56 or 64 kbps			
	Band 1	\$20.30	\$89.14

	Band 2		\$29.03	\$89.14
	Band 3		\$38.72	\$89.14
	Band 4		\$51.02	\$89.14
	Band 5		\$74.70	\$89.14
	Band 6		\$139.46	\$89.14
DS1 4 Wire Digital Data Loop DS1/T1/ISDN-PRI				
	Band 1		\$64.49	\$112.75
	Band 2		\$74.96	\$112.75
	Band 3		\$84.83	\$112.75
	Band 4		\$97.36	\$112.75
	Band 5		\$124.02	\$112.75
	Band 6		\$194.40	\$112.75
	DS3		ICB	
LOCAL SERVICES				
	Band 1		\$4.44	See NRC Section
	Band 2		\$4.99	See NRC Section
	Band 3		\$5.77	See NRC Section
	Band 4		\$6.59	See NRC Section
	Band 5		\$7.40	See NRC Section
	Band 6		\$8.43	See NRC Section
	ISDN		ICB	
	CENTREX		ICB	
	PBS		ICB	
	DS1		ICB	
FEATURES				
	CCF Package *		\$0.23	\$3.21
	CLASS Package *		\$4.74	\$5.76
	CENTREX Package *		\$10.47	\$36.66
	- 3 Way Conf/Consult/Hold Transfer		\$1.80	\$21.12
	- Conf Calling - 6 Way Station Control		\$2.35	\$31.00
	- Dial Transfer to Tandem Tie Line		\$0.12	\$141.86
	- Direct Connect		\$0.03	\$24.28
	- Meet Me Conference		\$17.03	\$44.86
	- Multi-Hunt Service		\$0.08	\$27.05
INTERNATIONAL SERVICES				
	RCF Residential	Commission Order	\$0.00	\$0.00
	RCF Business	Commission Order	\$0.00	\$0.00
	Call Path Residential	Commission Order	\$0.00	\$0.00
	Call Path Business	Commission Order	\$0.00	\$0.00
		Should be tracking for potential recovery through permanent number portability.	Will be determined in Florida docket 950737-TP	
IMP RATES SPECIFIC TO ACCESS SETTLEMENTS				

	Per INP Line		\$5.89	
			\$0.002085	
	DS1	See attached transport worksheet		\$222.95
	DS3	See attached transport worksheet		\$249.16
	Common		\$0.000711	N/A
	End Office		\$0.003671	NA
	Tandem Switching		\$0.002085	NA
	Transport			
	DS1	Rate Varies		\$222.95
	DS3	Rate Varies		\$249.16
	Common		\$0.000711	N/A
INTERCONNECTORS				
These rates apply when collocation is not involved. For collocation rates, see the appropriate tariff.				
	DS0 Elec X-Conn (DS0 UNECC)		\$0.94	N/A
	DS1 Elec X-Conn (DS1 UNECC)		\$2.93	N/A
	DS3 Elec X-Conn (DS3 UNECC)		\$25.85	N/A
	DS1 Facility Cross Connect: 1/2 of a DS1 UNECC consisting of one DSX panel and high frequency cable.		\$1.47	N/A
CONTINGENT CHANNELS				
INTERCONNECTORS				
	STP Port		\$422.40	\$308.00
	STP Switching		\$0.76	N/A
	STP Transport Link 56.0 Kpbs SS7 Link per month	IES Tariff	\$82.00	N/A
	STP Transport Link 56.0 Kpbs SS7 Link per mile	IES Tariff	\$4.80	N/A
	STP Transport Link 1.544 Mbps SS7 Link per month	IES Tariff	\$97.50	N/A
	STP Transport Link 1.544 Mbps SS7 Link per mile	IES Tariff	\$20.00	N/A
	Multiplexing DS1 to DS0	IES Tariff	\$300.00	\$142.00
	Originating Point Code (OPC)	IES Tariff		\$22.30
	GlobalTitle Address Translation (GTT)	IES Tariff		\$11.15
LINE REGISTRATION SYSTEMS				
	LIDB Database Transport per query	IES Tariff	\$0.0016	
	LIDB Database per query	IES Tariff	\$0.0366	
	Toll Free Code Access Service query	IES Tariff	\$0.008822	
	Toll Free Code Optional Service query	IES Tariff	\$0.001405	
DIRECTORY ASSISTANCE SERVICE				
	DA Database Listing & Update per listing or update		\$0.05	
	DA Data Base Query Service per query		\$0.0100	
TOLL & LOCAL OPERATOR SERVICES				

Toll and Local Assistance Service (Live)		\$0.414	
DA OPERATOR SERVICE			
DA Operator Service (Live)		\$0.353	
PER DSO EQUIVALENT PORT			
Per DSO Equivalent Port		\$15.81	\$187.50
MONTHLY CHARGE			
Monthly Charge		\$41.00	
TAPE CHARGE			
Tape Charge		\$50.00	
OSS INTERFACES			
OSS Interfaces		ICB	

LOOPS

Exchange	CLLI	Band	2 Wire Voice Grade Rate	4 Wire Voice Grade Rate	DS0 2 Wire Digital Data Loop or Interconnection ADSL/ISDN-BRI	DS0 4 Wire Digital Data 56 or 64 kbps	DS1 4 Wire Digital Data DS1/T1/ISDN-PRI Loop or Interconnection
----------	------	------	----------------------------	----------------------------	--	---	--

Maitland XA	MTLDFLXA	1	\$ 10.78	\$ 18.80	\$ 11.65	\$ 20.30	\$ 64.49
Maitland TC	MTLDFLTC	1	\$ 10.78	\$ 18.80	\$ 11.65	\$ 20.30	\$ 64.49
Tallahassee - Calhoun	TLHSFLXA	1	\$ 10.78	\$ 18.80	\$ 11.65	\$ 20.30	\$ 64.49
Tallahassee - FSU	TLHSFLXE	1	\$ 10.78	\$ 18.80	\$ 11.65	\$ 20.30	\$ 64.49
Destin	DESTFLXA	1	\$ 10.78	\$ 18.80	\$ 11.65	\$ 20.30	\$ 64.49
South Fort Meyers	FTMYFLXC	1	\$ 10.78	\$ 18.80	\$ 11.65	\$ 20.30	\$ 64.49
Boca Grande	BCGRFLXA	1	\$ 10.78	\$ 18.80	\$ 11.65	\$ 20.30	\$ 64.49
Murdock	MRDCFLXA	1	\$ 10.78	\$ 18.80	\$ 11.65	\$ 20.30	\$ 64.49
Fort Myers	FTMYFLXA	1	\$ 10.78	\$ 18.80	\$ 11.65	\$ 20.30	\$ 64.49
Winter Park	WNPKFLXA	1	\$ 10.78	\$ 18.80	\$ 11.65	\$ 20.30	\$ 64.49
Fort Myers Beach	FTMBFLXA	1	\$ 10.78	\$ 18.80	\$ 11.65	\$ 20.30	\$ 64.49
Lake Brantley	LKBRFLXA	1	\$ 10.78	\$ 18.80	\$ 11.65	\$ 20.30	\$ 64.49
North Naples	NNPLFLXA	1	\$ 10.78	\$ 18.80	\$ 11.65	\$ 20.30	\$ 64.49
Naples Moorings	NPLSFLXD	1	\$ 10.78	\$ 18.80	\$ 11.65	\$ 20.30	\$ 64.49
Marco Island	MOISFLXA	2	\$ 15.41	\$ 26.88	\$ 16.65	\$ 29.03	\$ 74.96
Altamonte Springs	ALSPFLXA	2	\$ 15.41	\$ 26.88	\$ 16.65	\$ 29.03	\$ 74.96

Iona	IONAFLXA	2	\$ 15.41	\$ 26.88	\$	16.65	\$ 29.03	\$	74.96
Goldenrod	GLRDFLXA	2	\$ 15.41	\$ 26.88	\$	16.65	\$ 29.03	\$	74.96
Fort Walton Beach XB	FTWBFLXB	2	\$ 15.41	\$ 26.88	\$	16.65	\$ 29.03	\$	74.96
Fort Walton Beach XA	FTWBFLXA	2	\$ 15.41	\$ 26.88	\$	16.65	\$ 29.03	\$	74.96
Buenaventura Lakes	KSSMFLXD	2	\$ 15.41	\$ 26.88	\$	16.65	\$ 29.03	\$	74.96
Tallahassee - Willis	TLHSFLXB	2	\$ 15.41	\$ 26.88	\$	16.65	\$ 29.03	\$	74.96
Shalimar	SHLMFLXA	2	\$ 15.41	\$ 26.88	\$	16.65	\$ 29.03	\$	74.96
Cypress Lake XA	CYLKFLXA	2	\$ 15.41	\$ 26.88	\$	16.65	\$ 29.03	\$	74.96
Casselberry	CSLBFLXA	2	\$ 15.41	\$ 26.88	\$	16.65	\$ 29.03	\$	74.96
Fort Walton Beach XC	FTWBFLXC	2	\$ 15.41	\$ 26.88	\$	16.65	\$ 29.03	\$	74.96
Cypress Lake XB	CYLKFLXB	2	\$ 15.41	\$ 26.88	\$	16.65	\$ 29.03	\$	74.96
Orange City	ORCYFLXA	2	\$ 15.41	\$ 26.88	\$	16.65	\$ 29.03	\$	74.96
Ocala XJ	OCALFLXJ	2	\$ 15.41	\$ 26.88	\$	16.65	\$ 29.03	\$	74.96
North Fort Myers XA	NFMYFLXA	2	\$ 15.41	\$ 26.88	\$	16.65	\$ 29.03	\$	74.96
Cape Coral	CPCRFLXA	2	\$ 15.41	\$ 26.88	\$	16.65	\$ 29.03	\$	74.96
Bonita Springs	BNSPFLXA	2	\$ 15.41	\$ 26.88	\$	16.65	\$ 29.03	\$	74.96
Sanibel-Captiva Islands	SNISFLXA	2	\$ 15.41	\$ 26.88	\$	16.65	\$ 29.03	\$	74.96
West Kissimmee	KSSMFLXB	2	\$ 15.41	\$ 26.88	\$	16.65	\$ 29.03	\$	74.96
Kissimmee	KSSMFLXA	2	\$ 15.41	\$ 26.88	\$	16.65	\$ 29.03	\$	74.96
Windermere	WNRDFLXA	3	\$ 20.54	\$ 35.85	\$	22.20	\$ 38.72	\$	84.83
Highlands	OCALFLXC	3	\$ 20.54	\$ 35.85	\$	22.20	\$ 38.72	\$	84.83
Tallahassee - Perkins	TLHSFLXH	3	\$ 20.54	\$ 35.85	\$	22.20	\$ 38.72	\$	84.83
Eustis	ESTSFLXA	3	\$ 20.54	\$ 35.85	\$	22.20	\$ 38.72	\$	84.83
San Carlos Park	SCPKFLXA	3	\$ 20.54	\$ 35.85	\$	22.20	\$ 38.72	\$	84.83
North Cape Coral	CPCRFLXB	3	\$ 20.54	\$ 35.85	\$	22.20	\$ 38.72	\$	84.83
Tallahassee Blairstone	TLHSFLXD	3	\$ 20.54	\$ 35.85	\$	22.20	\$ 38.72	\$	84.83
Port Charlotte	PTCTFLXA	3	\$ 20.54	\$ 35.85	\$	22.20	\$ 38.72	\$	84.83
Golden Gate	GLGCFLXA	3	\$ 20.54	\$ 35.85	\$	22.20	\$ 38.72	\$	84.83
Tavares	TVRSFLXA	3	\$ 20.54	\$ 35.85	\$	22.20	\$ 38.72	\$	84.83
Apopka	APPKFLXA	3	\$ 20.54	\$ 35.85	\$	22.20	\$ 38.72	\$	84.83
Westville	WSTVFLXA	3	\$ 20.54	\$ 35.85	\$	22.20	\$ 38.72	\$	84.83
Ocala XA	OCALFLXA	3	\$ 20.54	\$ 35.85	\$	22.20	\$ 38.72	\$	84.83
Tallahassee - Mabry	TLHSFLXC	3	\$ 20.54	\$ 35.85	\$	22.20	\$ 38.72	\$	84.83
North Fort Myers XB	NFMYFLXB	3	\$ 20.54	\$ 35.85	\$	22.20	\$ 38.72	\$	84.83
Naples South East	NPLSFLXC	3	\$ 20.54	\$ 35.85	\$	22.20	\$ 38.72	\$	84.83
Winter Garden	WNGRFLXA	3	\$ 20.54	\$ 35.85	\$	22.20	\$ 38.72	\$	84.83
Leesburg	LSBGFLXA	3	\$ 20.54	\$ 35.85	\$	22.20	\$ 38.72	\$	84.83
Lady Lake (753)	LDLKFLXA	3	\$ 20.54	\$ 35.85	\$	22.20	\$ 38.72	\$	84.83
Deltona Lakes	ORCYFLXC	3	\$ 20.54	\$ 35.85	\$	22.20	\$ 38.72	\$	84.83
Sebring	SBNGFLXA	3	\$ 20.54	\$ 35.85	\$	22.20	\$ 38.72	\$	84.83
Shady Road	OCALFLXB	4	\$ 27.09	\$ 47.24	\$	29.26	\$ 51.02	\$	97.36
Silver Springs Shores	SVSSFLXA	4	\$ 27.09	\$ 47.24	\$	29.26	\$ 51.02	\$	97.36
Clermont	CLMTFLXA	4	\$ 27.09	\$ 47.24	\$	29.26	\$ 51.02	\$	97.36
Tallahassee Thomasville	TLHSFLXF	4	\$ 27.09	\$ 47.24	\$	29.26	\$ 51.02	\$	97.36
Lehigh Acres	LHACFLXA	4	\$ 27.09	\$ 47.24	\$	29.26	\$ 51.02	\$	97.36
East Fort Meyers	FTMYFLXB	4	\$ 27.09	\$ 47.24	\$	29.26	\$ 51.02	\$	97.36
Montverde	MTVRFLXA	4	\$ 27.09	\$ 47.24	\$	29.26	\$ 51.02	\$	97.36
Valparaiso/678	VLPRFLXA	4	\$ 27.09	\$ 47.24	\$	29.26	\$ 51.02	\$	97.36

Beverly Hills	BVHFLXA	4	\$ 27.09	\$ 47.24	\$ 29.26	\$ 51.02	\$ 97.36
Cape Haze	CPHZFLXA	4	\$ 27.09	\$ 47.24	\$ 29.26	\$ 51.02	\$ 97.36
Dade City	DDCYFLXA	4	\$ 27.09	\$ 47.24	\$ 29.26	\$ 51.02	\$ 97.36
Punta Gorda	PNGRFLXA	4	\$ 27.09	\$ 47.24	\$ 29.26	\$ 51.02	\$ 97.36
Mount Dora	MTDRFLXA	4	\$ 27.09	\$ 47.24	\$ 29.26	\$ 51.02	\$ 97.36
Crestview	CRVWFLXA	4	\$ 27.09	\$ 47.24	\$ 29.26	\$ 51.02	\$ 97.36
Crystal River	CRRVFLXA	4	\$ 27.09	\$ 47.24	\$ 29.26	\$ 51.02	\$ 97.36
Lake Helen	LKHLFLXA	4	\$ 27.09	\$ 47.24	\$ 29.26	\$ 51.02	\$ 97.36
Clewiston	CLTNFLXA	4	\$ 27.09	\$ 47.24	\$ 29.26	\$ 51.02	\$ 97.36
Sea Grove Beach	SGBHFLXA	4	\$ 27.09	\$ 47.24	\$ 29.26	\$ 51.02	\$ 97.36
St. Cloud	STCDFLXA	4	\$ 27.09	\$ 47.24	\$ 29.26	\$ 51.02	\$ 97.36
Homosassa Spgs	HMSPFLEXA	4	\$ 27.09	\$ 47.24	\$ 29.26	\$ 51.02	\$ 97.36
Inverness	INVRFLXA	4	\$ 27.09	\$ 47.24	\$ 29.26	\$ 51.02	\$ 97.36
Oklawaha	OKLWFLXA	4	\$ 27.09	\$ 47.24	\$ 29.26	\$ 51.02	\$ 97.36
Madison	MDSNFLXA	4	\$ 27.09	\$ 47.24	\$ 29.26	\$ 51.02	\$ 97.36
Pine Island	PNISFLXA	4	\$ 27.09	\$ 47.24	\$ 29.26	\$ 51.02	\$ 97.36
Avon Park	AVPKFLXA	4	\$ 27.09	\$ 47.24	\$ 29.26	\$ 51.02	\$ 97.36
Silver Springs	SVSPFLXA	4	\$ 27.09	\$ 47.24	\$ 29.26	\$ 51.02	\$ 97.36

Bellevue	BLWVFLXA	5	\$ 39.66	\$ 69.17	\$ 42.84	\$ 74.70	\$ 124.02
Chassohowitza	CHSWFLXA	5	\$ 39.66	\$ 69.17	\$ 42.84	\$ 74.70	\$ 124.02
Immokalee	IMKLFLXA	5	\$ 39.66	\$ 69.17	\$ 42.84	\$ 74.70	\$ 124.02
Wildwood	WLWDFLXA	5	\$ 39.66	\$ 69.17	\$ 42.84	\$ 74.70	\$ 124.02
Moore Heaven	MRHNFLXA	5	\$ 39.66	\$ 69.17	\$ 42.84	\$ 74.70	\$ 124.02
Arcadia	ARCDFLXA	5	\$ 39.66	\$ 69.17	\$ 42.84	\$ 74.70	\$ 124.02
Marianna	MRNNFLXA	5	\$ 39.66	\$ 69.17	\$ 42.84	\$ 74.70	\$ 124.02
Lake Placid	LKPCFLXA	5	\$ 39.66	\$ 69.17	\$ 42.84	\$ 74.70	\$ 124.02
Okeechobee	OKCBFLXA	5	\$ 39.66	\$ 69.17	\$ 42.84	\$ 74.70	\$ 124.02
Bushnell	BSHNFLXA	5	\$ 39.66	\$ 69.17	\$ 42.84	\$ 74.70	\$ 124.02
Santa Rosa Beach	SNRSFLXA	5	\$ 39.66	\$ 69.17	\$ 42.84	\$ 74.70	\$ 124.02
Alva	ALVAFLXA	5	\$ 39.66	\$ 69.17	\$ 42.84	\$ 74.70	\$ 124.02
Tallahassee XG	TLHSFLXG	5	\$ 39.66	\$ 69.17	\$ 42.84	\$ 74.70	\$ 124.02
Astor	ASTRFLXA	5	\$ 39.66	\$ 69.17	\$ 42.84	\$ 74.70	\$ 124.02
Spring Lake	SLHLFLXA	5	\$ 39.66	\$ 69.17	\$ 42.84	\$ 74.70	\$ 124.02
Wauchula	WCHLFLXA	5	\$ 39.66	\$ 69.17	\$ 42.84	\$ 74.70	\$ 124.02
Starke	STRKFLXA	5	\$ 39.66	\$ 69.17	\$ 42.84	\$ 74.70	\$ 124.02
San Antonio	SNANFLXA	5	\$ 39.66	\$ 69.17	\$ 42.84	\$ 74.70	\$ 124.02
Labelle	LBLFLXA	5	\$ 39.66	\$ 69.17	\$ 42.84	\$ 74.70	\$ 124.02
Groveland	GVLDFLXA	5	\$ 39.66	\$ 69.17	\$ 42.84	\$ 74.70	\$ 124.02
Bowling Green	BWLGFLEXA	5	\$ 39.66	\$ 69.17	\$ 42.84	\$ 74.70	\$ 124.02
Fort Meade	FTMDFLXA	5	\$ 39.66	\$ 69.17	\$ 42.84	\$ 74.70	\$ 124.02
Howey-In-The-Hills	HOWYFLXA	5	\$ 39.66	\$ 69.17	\$ 42.84	\$ 74.70	\$ 124.02
Forest	OCNFFLXA	5	\$ 39.66	\$ 69.17	\$ 42.84	\$ 74.70	\$ 124.02
Trilacoochee	TLCHFLXA	5	\$ 39.66	\$ 69.17	\$ 42.84	\$ 74.70	\$ 124.02
Crawfordville	CFVLFLXA	5	\$ 39.66	\$ 69.17	\$ 42.84	\$ 74.70	\$ 124.02
Everglades	EVRGFLXA	5	\$ 39.66	\$ 69.17	\$ 42.84	\$ 74.70	\$ 124.02

Salt Springs	SSPRFLXA	6	\$ 74.05	\$ 129.13	\$ 79.98	\$ 139.46	\$ 194.40
DeFuniak Springs	DFSPFLXA	6	\$ 74.05	\$ 129.13	\$ 79.98	\$ 139.46	\$ 194.40
Umatilla	UMTLFLXA	6	\$ 74.05	\$ 129.13	\$ 79.98	\$ 139.46	\$ 194.40

Sneads	SNDSFLXA	6	\$ 74.05	\$ 129.13	\$	79.98	\$ 139.46	\$	194.40
Williston	WLSTFLXA	6	\$ 74.05	\$ 129.13	\$	79.98	\$ 139.46	\$	194.40
Grand Ridge	GDRGFLXA	6	\$ 74.05	\$ 129.13	\$	79.98	\$ 139.46	\$	194.40
Zolfo Springs	ZLSPFLXA	6	\$ 74.05	\$ 129.13	\$	79.98	\$ 139.46	\$	194.40
Monticello	MNTIFLXA	6	\$ 74.05	\$ 129.13	\$	79.98	\$ 139.46	\$	194.40
St. Marks	STMKFLXA	6	\$ 74.05	\$ 129.13	\$	79.98	\$ 139.46	\$	194.40
Freeport	FRPTFLXA	6	\$ 74.05	\$ 129.13	\$	79.98	\$ 139.46	\$	194.40
Bonifay	BNFYFLXA	6	\$ 74.05	\$ 129.13	\$	79.98	\$ 139.46	\$	194.40
Cottondale	CTDLFLXA	6	\$ 74.05	\$ 129.13	\$	79.98	\$ 139.46	\$	194.40
Lawtey	LWTYFLXA	6	\$ 74.05	\$ 129.13	\$	79.98	\$ 139.46	\$	194.40
Panacea	PANCFIXA	6	\$ 74.05	\$ 129.13	\$	79.98	\$ 139.46	\$	194.40
Reynolds Hill	RYHLFLXA	6	\$ 74.05	\$ 129.13	\$	79.98	\$ 139.46	\$	194.40
Sopchoppy	SPCPFLXA	6	\$ 74.05	\$ 129.13	\$	79.98	\$ 139.46	\$	194.40
Malone	MALNFLXA	6	\$ 74.05	\$ 129.13	\$	79.98	\$ 139.46	\$	194.40
Baker	BAKRFLXA	6	\$ 74.05	\$ 129.13	\$	79.98	\$ 139.46	\$	194.40
Alford	ALFRFLXA	6	\$ 74.05	\$ 129.13	\$	79.98	\$ 139.46	\$	194.40
Kingsley Lake	KGLKFLXA	6	\$ 74.05	\$ 129.13	\$	79.98	\$ 139.46	\$	194.40
Greenville	GNVFLXA	6	\$ 74.05	\$ 129.13	\$	79.98	\$ 139.46	\$	194.40
Ponce de Leon	PNLNFLXA	6	\$ 74.05	\$ 129.13	\$	79.98	\$ 139.46	\$	194.40
Kenansville	KNVFLXA	6	\$ 74.05	\$ 129.13	\$	79.98	\$ 139.46	\$	194.40
Lee	LEE FLXA	6	\$ 74.05	\$ 129.13	\$	79.98	\$ 139.46	\$	194.40
Glendale	GLDLFLXA	6	\$ 74.05	\$ 129.13	\$	79.98	\$ 139.46	\$	194.40
Cherry Lake	CHLKFLXA	6	\$ 74.05	\$ 129.13	\$	79.98	\$ 139.46	\$	194.40
Greenwood	GNWDFLXA	6	\$ 74.05	\$ 129.13	\$	79.98	\$ 139.46	\$	194.40

LOCAL SWITCHING

EXCHANGE	BAN D	RATE
ALTAMONTE SPRINGS, FL	1	\$7.00
BONITA SPRINGS, FL	1	\$7.00
CYPRESS LAKE, FL	1	\$7.00
FT MYERS BEACH, FL	1	\$7.00
FT. MYERS, FL	1	\$7.00
FT. WALTON BEACH, FL	1	\$7.00
GOLDENROD, FL	1	\$7.00
LAKE BRANTLEY, FL	1	\$7.00
TALLAHASSEE, FL	1	\$7.00
WINTER PARK, FL	1	\$7.00
APOPKA, FL	2	\$7.00

CASSELBERRY, FL	2	\$7.00
CHERRY LAKE, FL	2	\$7.00
EUSTIS, FL	2	\$7.00
FREEPORT, FL	2	\$7.00
KISSIMMEE, FL	2	\$7.00
LEESBURG, FL	2	\$7.00
NAPLES MOORINGS, FL	2	\$7.00
NAPLES, FL	2	\$7.00
OCALA, FL	2	\$7.00
ORANGE CITY, FL	2	\$7.00
PORT CHARLOTTE, FL	2	\$7.00
TAVARES, FL	2	\$7.00
VALPRAISO, FL	2	\$7.00
WILDWOOD, FL	2	\$7.00

ALFORD, FL	3	\$7.00
ARCADIA, FL	3	\$7.00
ASTOR, FL	3	\$7.00
AVON PARK, FL	3	\$7.00
BAKER, FL	3	\$7.00
BELLEVIEW, FL	3	\$7.00
BEVERLY HILLS, FL	3	\$7.00
BONIFAY, FL	3	\$7.00
BOWLING GREEN, FL	3	\$7.00
COTTONDALE, FL	3	\$7.00
CRESTVIEW, FL	3	\$7.00
CRYSTAL RIVER, FL	3	\$7.00
DADE CITY, FL	3	\$7.00
DESTIN, FL	3	\$7.00
EVERGLADES, FL	3	\$7.00
FOREST, FL	3	\$7.00
GLENDALE, FL	3	\$7.00
GREENVILLE, FL	3	\$7.00
GREENWOOD, FL	3	\$7.00
HOMOSASSA SPRINGS, FL	3	\$7.00
HOWEY-IN-THE-HILLS, FL	3	\$7.00
IMMOKALEE, FL	3	\$7.00
INVERNESS, FL	3	\$7.00
KENANSVILLE, FL	3	\$7.00
KINGSLEY LAKE, FL	3	\$7.00
LABELLE, FL	3	\$7.00
LADY LAKE, FL	3	\$7.00
LAWTEY, FL	3	\$7.00
LEE, FL	3	\$7.00
LEHIGH ACRES, FL	3	\$7.00
MADISON, FL	3	\$7.00

MAITLAND, FL	3	\$7.00
MALONE, FL	3	\$7.00
MARCO ISLAND, FL	3	\$7.00
MONTICELLO , FL	3	\$7.00
MONTVERDE, FL	3	\$7.00
MT. DORA, FL	3	\$7.00
NORTH NAPLES, FL	3	\$7.00
OKEECHOBEE, FL	3	\$7.00
OKLAWAHA, FL	3	\$7.00
PANACEA, FL	3	\$7.00
PONCE DE LEON, FL	3	\$7.00
REYNOLDS HILL, FL	3	\$7.00
SALT SPRINGS, FL	3	\$7.00
SANTA ROSA, FL	3	\$7.00
SEA GROVE BEACH, FL	3	\$7.00
SHADY ROAD, FL	3	\$7.00
SILVER SPRINGS SHORES, FL	3	\$7.00
SNEADS, FL	3	\$7.00
SOPCHOPPY, FL	3	\$7.00
ST. CLOUD, FL	3	\$7.00
ST. MARKS, FL	3	\$7.00
STARKE, FL	3	\$7.00
UMATILLA, FL	3	\$7.00
WEST KISSIMMEE, FL	3	\$7.00
WESTVILLE, FL	3	\$7.00
WILLISTON, FL	3	\$7.00
WINTER GARDEN, FL	3	\$7.00
BOCA GRANDE, FL	4	\$7.00
CAPE CORAL, FL	4	\$7.00
CLERMONT, FL	4	\$7.00
CLEWISTON, FL	4	\$7.00
CRAWFORDVILLE, FL	4	\$7.00
DEFUNIAK SPRINGS, FL	4	\$7.00
FORT MEADE, FL	4	\$7.00
MOORE HAVEN, FL	4	\$7.00
NORTH CAPE CORAL, FL	4	\$7.00
NORTH FT. MYERS, FL	4	\$7.00
PINE ISLAND, FL	4	\$7.00
REEDY CREEK, FL	4	\$7.00
WAUCHULA, FL	4	\$7.00
WINDERMERE, FL	4	\$7.00
ZOLFO SPRINGS, FL	4	\$7.00
BUSHNELL, FL	5	\$7.00

CAPE HAZE, FL	5	\$7.00
GROVELAND, FL	5	\$7.00
LAKE PLACID, FL	5	\$7.00
MARIANNA, FL	5	\$7.00
PUNTA GORDA, FL	5	\$7.00
SAN ANTONIO, FL	5	\$7.00
SANIBEL ISLAND, FL	5	\$7.00
SEBRING, FL	5	\$7.00
SHALIMAR, FL	5	\$7.00
SPRING LAKE, FL	5	\$7.00
TRILLACOOCHEE, FL	5	\$7.00

END OFFICE

<u>EXCHANGE</u>	<u>RATE</u>
ALFORD, FL	\$0.003671
APOPKA, FL	\$0.003671
ARCADIA, FL	\$0.003671
ASTOR, FL	\$0.003671
AVON PARK, FL	\$0.003671
BAKER, FL	\$0.003671
BELLEVIEW, FL	\$0.003671
BEVERLY HILLS, FL	\$0.003671
BOCA GRANDE, FL	\$0.003671
BONIFAY, FL	\$0.003671
BONITA SPRINGS, FL	\$0.003671
BOWLING GREEN, FL	\$0.003671
BUSHNELL, FL	\$0.003671
CAPE CORAL, FL	\$0.003671
CAPE HAZE, FL	\$0.003671
CASSELBERRY, FL	\$0.003671
CHERRY LAKE, FL	\$0.003671
CLERMONT, FL	\$0.003671
CLEWISTON, FL	\$0.003671
COTTONDALE, FL	\$0.003671
CRAWFORDVILLE, FL	\$0.003671
CRESTVIEW, FL	\$0.003671

CRYSTAL RIVER, FL	\$0.003671
CYPRESS LAKE, FL	\$0.003671
DADE CITY, FL	\$0.003671
DEFUNIAK SPRINGS, FL	\$0.003671
DESTIN, FL	\$0.003671
EUSTIS, FL	\$0.003671
EVERGLADES, FL	\$0.003671
FOREST, FL	\$0.003671
FORT MEADE, FL	\$0.003671
FREEPORT, FL	\$0.003671
FT MYERS BEACH, FL	\$0.003671
FT. MYERS, FL	\$0.003671
FT. WALTON BEACH, FL	\$0.003671
GLENDALE, FL	\$0.003671
GOLDENROD, FL	\$0.003671
GREENVILLE, FL	\$0.003671
GREENWOOD, FL	\$0.003671
GROVELAND, FL	\$0.003671
HOMOSASSA SPRINGS, FL	\$0.003671
HOWEY-IN-THE-HILLS, FL	\$0.003671
IMMOKALEE, FL	\$0.003671
INVERNESS, FL	\$0.003671
KENANSVILLE, FL	\$0.003671
KINGSLEY LAKE, FL	\$0.003671
KISSIMMEE, FL	\$0.003671
LABELLE, FL	\$0.003671
LADY LAKE, FL	\$0.003671
LAKE BRANTLEY,FL	\$0.003671
LAKE PLACID, FL	\$0.003671
LAWTEY, FL	\$0.003671
LEE, FL	\$0.003671
LEESBURG, FL	\$0.003671
LEHIGH ACRES, FL	\$0.003671
MADISON, FL	\$0.003671
MAITLAND, FL	\$0.003671
MALONE, FL	\$0.003671
MARCO ISLAND, FL	\$0.003671
MARIANNA, FL	\$0.003671
MONTICELLO , FL	\$0.003671
MONTVERDE, FL	\$0.003671
MOORE HAVEN, FL	\$0.003671
MT. DORA, FL	\$0.003671
NAPLES MOORINGS, FL	\$0.003671
NAPLES, FL	\$0.003671
NORTH CAPE CORAL, FL	\$0.003671

NORTH FT. MYERS, FL	\$0.003671
NORTH NAPLES, FL	\$0.003671
OCALA, FL	\$0.003671
OKEECHOBEE, FL	\$0.003671
OKLAWAHA, FL	\$0.003671
ORANGE CITY, FL	\$0.003671
PANACEA, FL	\$0.003671
PINE ISLAND, FL	\$0.003671
PONCE DE LEON, FL	\$0.003671
PORT CHARLOTTE, FL	\$0.003671
PUNTA GORDA, FL	\$0.003671
REEDY CREEK, FL	\$0.003671
REYNOLDS HILL, FL	\$0.003671
SALT SPRINGS, FL	\$0.003671
SAN ANTONIO, FL	\$0.003671
SANIBEL ISLAND, FL	\$0.003671
SANTA ROSA, FL	\$0.003671
SEA GROVE BEACH, FL	\$0.003671
SEBRING, FL	\$0.003671
SHADY ROAD, FL	\$0.003671
SHALIMAR, FL	\$0.003671
SILVER SPRINGS	\$0.003671
SHORES, FL	
SNEADS, FL	\$0.003671
SOPCHOPPY, FL	\$0.003671
SPRING LAKE, FL	\$0.003671
ST. CLOUD, FL	\$0.003671
ST. MARKS, FL	\$0.003671
STARKE, FL	\$0.003671
TALLAHASSEE, FL	\$0.003671
TAVARES, FL	\$0.003671
TRILLACOOCHEE, FL	\$0.003671
UMATILLA, FL	\$0.003671
VALPRAISO, FL	\$0.003671
WAUCHULA, FL	\$0.003671
WEST KISSIMMEE, FL	\$0.003671
WESTVILLE, FL	\$0.003671
WILDWOOD, FL	\$0.003671
WILLISTON, FL	\$0.003671
WINDERMERE, FL	\$0.003671
WINTER GARDEN, FL	\$0.003671
WINTER PARK, FL	\$0.003671
ZOLFO SPRINGS, FL	\$0.003671

TRANSPORT BANDS

Florida Bands

9/8/98 filing

Bands	DS1	DS3
1	\$ 71.95	\$ 1,178.36
2	\$ 86.39	\$ 1,771.38
3	\$ 114.14	\$ 2,356.73
4	\$ 124.39	\$ 2,654.34
5	\$ 131.95	\$ 2,771.35
6	\$ 136.41	\$ 2,949.75
7	\$ 138.82	\$ 3,247.36
8	\$ 149.76	\$ 3,535.09
9	\$ 156.33	\$ 3,832.70
10	\$ 158.34	\$ 3,949.71
11	\$ 174.14	\$ 4,425.72
12	\$ 174.82	\$ 5,011.07
13	\$ 184.39	\$ 5,018.74
14	\$ 188.84	\$ 5,308.68
15	\$ 191.95	\$ 5,512.99
16	\$ 196.34	\$ 5,604.09
17	\$ 202.19	\$ 5,901.70
18	\$ 206.77	\$ 6,197.11
19	\$ 210.77	\$ 6,487.04
20	\$ 227.25	\$ 6,494.72
21	\$ 229.95	\$ 6,512.95
22	\$ 238.53	\$ 6,691.36
23	\$ 247.76	\$ 7,080.06
24	\$ 248.78	\$ 7,284.38
25	\$ 256.34	\$ 7,375.47
26	\$ 260.80	\$ 7,665.40
27	\$ 263.21	\$ 7,673.08
28	\$ 265.56	\$ 8,258.42
29	\$ 271.23	\$ 8,760.35
30	\$ 274.14	\$ 9,760.31
31	\$ 278.72	\$ 9,938.72
32	\$ 307.76	\$11,117.08
33	\$ 318.00	\$11,821.63
34	\$ 326.58	\$12,593.05
35	\$ 331.16	\$12,888.46

36	\$ 335.16	\$13,771.42
37	\$ 345.60	\$15,068.99
38	\$ 363.56	
39	\$ 389.95	
40	\$ 395.62	
41	\$ 408.97	
42	\$ 454.53	
43	\$ 504.27	
44	\$ 514.53	
45	\$ 533.35	
46	\$ 570.34	
47	\$ 628.66	
48	\$458.07	
49	\$474.31	
50	\$477.27	
51	\$519.78	
52	\$524.05	
53	\$526.54	
54	\$578.30	
55	\$665.28	
56	\$696.81	
57	\$729.33	
58	\$732.29	
59	\$835.55	
60	\$1,364.32	
61	\$1,773.11	
62	\$2,075.02	
63	\$2,181.90	
64	\$2,430.37	

TRANSPORT

Sprint Florida

Updated 6/24/99

09/98 E19 Price List

Originating	Terminating	Dedicated DS1	Dedicated DS3	
ALFRFLXA	CTDLFLXA	\$ 86.39	\$ 1,178.36	0.000711
ALFRFLXA	MRNNFLXA	\$ 149.76	\$ 2,356.73	0.000711
ALSPFLXA	APPKFLXA	\$ 71.95	\$ 1,178.36	0.000711
ALSPFLXA	CSLBFLXA	\$ 86.39	\$ 1,178.36	0.000711
ALSPFLXA	CLBRFLAD	\$ 156.33	\$ 3,535.09	0.000711
ALSPFLXA	EORNFLXA	\$ 114.14	\$ 2,356.73	0.000711
ALSPFLXA	GENVFLXA	\$ 114.14	\$ 2,356.73	0.000711
ALSPFLXA	GLRDFLXA	\$ 86.39	\$ 1,178.36	0.000711
ALSPFLXA	LKBRFLXA	\$ 71.95	\$ 1,178.36	0.000711
ALSPFLXA	LKBNFLXA	\$ 156.33	\$ 3,535.09	0.000711
ALSPFLXA	MTLDFLXA	\$ 71.95	\$ 1,178.36	0.000711
ALSPFLXA	MTVRFLXA	\$ 238.53	\$ 5,604.09	0.000711
ALSPFLXA	ORLDFLXA	\$ 114.14	\$ 2,356.73	0.000711
ALSPFLXA	OVIDFLCA	\$ 114.14	\$ 2,356.73	0.000711
ALSPFLXA	KSSMFLXC	\$ 174.14	\$ 3,535.09	0.000711
ALSPFLXA	SNFRFLMA	\$ 114.14	\$ 2,356.73	0.000711
ALSPFLXA	WNRDFLXA	\$ 174.14	\$ 3,535.09	0.000711
ALSPFLXA	WNGRFLXA	\$ 114.14	\$ 2,356.73	0.000711
ALSPFLXA	WNPKFLXA	\$ 86.39	\$ 1,178.36	0.000711
ALVAFLXA	BNSPFLXA	\$ 86.39	\$ 1,178.36	0.000711
ALVAFLXA	CPCRFLXA	\$ 136.41	\$ 2,771.35	0.000711
ALVAFLXA	FTMYFLXB	\$ 86.39	\$ 1,178.36	0.000711
ALVAFLXA	RGAPFLXA	\$ 158.34	\$ 2,949.75	0.000711
ALVAFLXA	FTMYFLXA	\$ 86.39	\$ 1,178.36	0.000711
ALVAFLXA	FTMBFLXA	\$ 71.95	\$ 1,178.36	0.000711
ALVAFLXA	LHACFLXA	\$ 86.39	\$ 1,178.36	0.000711
ALVAFLXA	CPCRFLXB	\$ 136.41	\$ 2,771.35	0.000711
ALVAFLXA	NFMYFLXA	\$ 136.41	\$ 2,771.35	0.000711
ALVAFLXA	PNISFLXA	\$ 71.95	\$ 1,178.36	0.000711
ALVAFLXA	SNISFLXA	\$ 71.95	\$ 1,178.36	0.000711
ALVAFLXA	FTMYFLXC	\$ 86.39	\$ 1,178.36	0.000711
APPKFLXA	CSLBFLXA	\$ 131.95	\$ 2,356.73	0.000711

APPKFLXA	CLBRFLAD	\$ 114.14	\$ 2,356.73	0.000711
APPKFLXA	EORNFLXA	\$ 114.14	\$ 2,356.73	0.000711
APPKFLXA	GLRDFLXA	\$ 131.95	\$ 2,356.73	0.000711
APPKFLXA	LKBRFLXA	\$ 71.95	\$ 1,178.36	0.000711
APPKFLXA	LKBNFLXA	\$ 114.14	\$ 2,356.73	0.000711
APPKFLXA	MTLDFLXA	\$ 71.95	\$ 1,178.36	0.000711
APPKFLXA	MTVRFLXA	\$ 210.77	\$ 4,425.72	0.000711
APPKFLXA	ORLDFLXA	\$ 114.14	\$ 2,356.73	0.000711
APPKFLXA	KSSMFLXC	\$ 131.95	\$ 2,356.73	0.000711
APPKFLXA	WNRDFLXA	\$ 131.95	\$ 2,356.73	0.000711
APPKFLXA	WNGRFLXA	\$ 71.95	\$ 1,178.36	0.000711
APPKFLXA	WNPKFLXA	\$ 71.95	\$ 1,178.36	0.000711
ASTRFLXA	CLMTFLXA	\$ 202.19	\$ 4,425.72	0.000711
ASTRFLXA	ESTSFLXA	\$ 202.19	\$ 4,425.72	0.000711
ASTRFLXA	GVLDFLXA	\$ 318.00	\$ 7,080.06	0.000711
ASTRFLXA	HOWYFLXA	\$ 326.58	\$ 7,673.08	0.000711
ASTRFLXA	LDLKFLXA	\$ 265.56	\$ 6,197.11	0.000711
ASTRFLXA	LSBGFLXA	\$ 202.19	\$ 4,425.72	0.000711
ASTRFLXA	MTVRFLXA	\$ 326.58	\$ 7,673.08	0.000711
ASTRFLXA	MTDRFLXA	\$ 202.19	\$ 4,425.72	0.000711
ASTRFLXA	TVRSFLXA	\$ 202.19	\$ 4,425.72	0.000711
ASTRFLXA	UMTLFLXA	\$ 138.82	\$ 3,247.36	0.000711
BAKRFLXA	CRVWFLXA	\$ 124.39	\$ 3,247.36	0.000711
BLVWFLXA	CITRFLXA	\$ 263.21	\$ 5,308.68	0.000711
BLVWFLXA	DNLNFLXA	\$ 184.39	\$ 3,832.70	0.000711
BLVWFLXA	OCNFFLXA	\$ 247.76	\$ 5,604.09	0.000711
BLVWFLXA	OCALFLXC	\$ 131.95	\$ 2,356.73	0.000711
BLVWFLXA	LDLKFLXB	\$ 86.39	\$ 1,771.38	0.000711
BLVWFLXA	MCINFLXA	\$ 263.21	\$ 5,308.68	0.000711
BLVWFLXA	OCALFLXA	\$ 138.82	\$ 2,654.34	0.000711
BLVWFLXA	OKLWFLXA	\$ 71.95	\$ 1,178.36	0.000711
BLVWFLXA	ORSPFLXA	\$ 263.21	\$ 5,308.68	0.000711
BLVWFLXA	SSPRFLXA	\$ 454.53	\$ 11,117.08	0.000711
BLVWFLXA	SVSSFLXA	\$ 71.95	\$ 1,178.36	0.000711
BVHLFLXA	CHSWFLXA	\$ 260.80	\$ 5,018.74	0.000711
BVHLFLXA	CRRVFLXA	\$ 188.84	\$ 3,247.36	0.000711
BVHLFLXA	HMSPFLXA	\$ 188.84	\$ 3,247.36	0.000711
BVHLFLXA	INVRFLXA	\$ 188.84	\$ 3,247.36	0.000711
BNFYFLXA	RYHLFLXA	\$ 71.95	\$ 1,771.38	0.000711
BNFYFLXA	WSTVFLXA	\$ 124.39	\$ 3,247.36	0.000711
BNSPFLXA	CYLKFLXA	\$ 86.39	\$ 1,178.36	0.000711
BNSPFLXA	FTMYFLXB	\$ 86.39	\$ 1,178.36	0.000711
BNSPFLXA	FTMYFLXA	\$ 86.39	\$ 1,178.36	0.000711
BNSPFLXA	FTMBFLXA	\$ 131.95	\$ 2,356.73	0.000711

BNSPFLXA	GLGCFLXA	\$ 86.39	\$ 1,178.36	0.000711
BNSPFLXA	NPLSFLXA	\$ 86.39	\$ 1,178.36	0.000711
BNSPFLXA	NPLSFLXD	\$ 86.39	\$ 1,178.36	0.000711
BNSPFLXA	NPLSFLXC	\$ 86.39	\$ 1,178.36	0.000711
BNSPFLXA	NNPLFLXA	\$ 86.39	\$ 1,178.36	0.000711
BWLGFLXA	WCHLFLXA	\$ 86.39	\$ 1,178.36	0.000711
BWLGFLXA	ZLSPFLXA	\$ 124.39	\$ 2,654.34	0.000711
KSSMFLXD	KSSMFLXA	\$ 71.95	\$ 1,771.38	0.000711
BSHNFLXA	WLWDFLXA	\$ 202.19	\$ 4,425.72	0.000711
CPCRFLXA	CYLKFLXA	\$ 136.41	\$ 2,771.35	0.000711
CPCRFLXA	FTMYFLXB	\$ 136.41	\$ 2,771.35	0.000711
CPCRFLXA	FTMYFLXA	\$ 136.41	\$ 2,771.35	0.000711
CPCRFLXA	FTMBFLXA	\$ 174.82	\$ 3,949.71	0.000711
CPCRFLXA	CPCRFLXB	\$ 136.41	\$ 2,771.35	0.000711
CPCRFLXA	NFMYFLXA	\$ 136.41	\$ 2,771.35	0.000711
CPCRFLXA	PNISFLXA	\$ 174.82	\$ 3,949.71	0.000711
CPCRFLXA	SNISFLXA	\$ 174.82	\$ 3,949.71	0.000711
CSLBFLXA	CLBRFLAD	\$ 174.14	\$ 3,535.09	0.000711
CSLBFLXA	EORNFLXA	\$ 131.95	\$ 2,356.73	0.000711
CSLBFLXA	GENVFLXA	\$ 131.95	\$ 2,356.73	0.000711
CSLBFLXA	GLRDFLXA	\$ 86.39	\$ 1,178.36	0.000711
CSLBFLXA	LKBRFLXA	\$ 131.95	\$ 2,356.73	0.000711
CSLBFLXA	LKBNFLXA	\$ 174.14	\$ 3,535.09	0.000711
CSLBFLXA	MTLDFLXA	\$ 131.95	\$ 2,356.73	0.000711
CSLBFLXA	MTVRFLXA	\$ 256.34	\$ 5,604.09	0.000711
CSLBFLXA	ORLDFLXA	\$ 131.95	\$ 2,356.73	0.000711
CSLBFLXA	OVIDFLCA	\$ 131.95	\$ 2,356.73	0.000711
CSLBFLXA	KSSMFLXC	\$ 191.95	\$ 3,535.09	0.000711
CSLBFLXA	SNFRFLMA	\$ 131.95	\$ 2,356.73	0.000711
CSLBFLXA	WNDRFLXA	\$ 191.95	\$ 3,535.09	0.000711
CSLBFLXA	WNGRFLXA	\$ 131.95	\$ 2,356.73	0.000711
CSLBFLXA	WNPKFLXA	\$ 86.39	\$ 1,178.36	0.000711
CHSWFLXA	CRRVFLXA	\$ 260.80	\$ 5,018.74	0.000711
CHSWFLXA	HMSPFLXA	\$ 71.95	\$ 1,771.38	0.000711
CHSWFLXA	INVRFLXA	\$ 260.80	\$ 5,018.74	0.000711
CHLKFLXA	GNVFLFLXA	\$ 331.16	\$ 8,760.35	0.000711
CHLKFLXA	LEE_FLXA	\$ 278.72	\$ 7,284.38	0.000711
CHLKFLXA	MDSNFLXA	\$ 206.77	\$ 5,512.99	0.000711
CLMTFLXA	CLBRFLAD	\$ 131.95	\$ 2,356.73	0.000711
CLMTFLXA	ESTSFLXA	\$ 86.39	\$ 1,178.36	0.000711
CLMTFLXA	GVLDFLXA	\$ 138.82	\$ 2,654.34	0.000711
CLMTFLXA	HOWYFLXA	\$ 210.77	\$ 4,425.72	0.000711
CLMTFLXA	LDLKFLXA	\$ 202.19	\$ 4,425.72	0.000711
CLMTFLXA	LSBGFLXA	\$ 86.39	\$ 1,178.36	0.000711

CLMTFLXA	LKBNFLXA	\$ 131.95	\$ 2,356.73	0.000711
CLMTFLXA	MTVRFLXA	\$ 210.77	\$ 4,425.72	0.000711
CLMTFLXA	MTDRFLXA	\$ 86.39	\$ 1,178.36	0.000711
CLMTFLXA	ORLDFLXA	\$ 174.14	\$ 3,535.09	0.000711
CLMTFLXA	KSSMFLXC	\$ 86.39	\$ 1,178.36	0.000711
CLMTFLXA	TVRSFLXA	\$ 86.39	\$ 1,178.36	0.000711
CLMTFLXA	UMTLFLXA	\$ 202.19	\$ 4,425.72	0.000711
CLMTFLXA	WNRDFLXA	\$ 191.95	\$ 3,535.09	0.000711
CLMTFLXA	WNGRFLXA	\$ 86.39	\$ 1,178.36	0.000711
CTDLFLXA	MRNNFLXA	\$ 86.39	\$ 1,178.36	0.000711
CFVLFLXA	ARPNFLXA *	\$ 504.27	\$ 11,821.63	0.000711
CFVLFLXA	CRBLFLXA	\$ 504.27	\$ 11,821.63	0.000711
CFVLFLXA	PNACFLXA	\$ 124.39	\$ 3,247.36	0.000711
CFVLFLXA	SPCPFLXA	\$ 271.23	\$ 6,512.95	0.000711
CFVLFLXA	STMKFLXA	\$ 124.39	\$ 3,247.36	0.000711
CFVLFLXA	TLHSFLXD	\$ 271.23	\$ 6,512.95	0.000711
CRVWFLXA	LRHLFLXA *	\$ 71.95	\$ 1,178.36	0.000711
CRRVFLXA	HMSPLFLXA	\$ 188.84	\$ 3,247.36	0.000711
CRRVFLXA	INVRFLXA	\$ 188.84	\$ 3,247.36	0.000711
CRRVFLXA	YNTWFLMA	\$ 227.25	\$ 4,425.72	0.000711
CYLKFLXA	FTMYFLXB	\$ 86.39	\$ 1,178.36	0.000711
CYLKFLXA	RGAPFLXA	\$ 71.95	\$ 1,771.38	0.000711
CYLKFLXA	FTMYFLXA	\$ 86.39	\$ 1,178.36	0.000711
CYLKFLXA	FTMBFLXA	\$ 71.95	\$ 1,178.36	0.000711
CYLKFLXA	LHACFLXA	\$ 86.39	\$ 1,178.36	0.000711
CYLKFLXA	CPCRFLXB	\$ 136.41	\$ 2,771.35	0.000711
CYLKFLXA	NFMYFLXA	\$ 71.95	\$ 1,178.36	0.000711
CYLKFLXA	PNISFLXA	\$ 71.95	\$ 1,178.36	0.000711
CYLKFLXA	SNISFLXA	\$ 71.95	\$ 1,178.36	0.000711
CYLKFLXA	FTMYFLXC	\$ 86.39	\$ 1,178.36	0.000711
DDCYFLXA	SNANFLXA	\$ 86.39	\$ 1,178.36	0.000711
DDCYFLXA	TLCHFLXA	\$ 86.39	\$ 1,178.36	0.000711
DDCYFLXA	ZPHYFLXA	\$ 71.95	\$ 1,178.36	0.000711
DFSPFLXA	FRPTFLXA	\$ 86.39	\$ 1,178.36	0.000711
DFSPFLXA	GLDLFLXA	\$ 124.39	\$ 3,247.36	0.000711
DFSPFLXA	PXTNFLXA *	\$ 131.95	\$ 2,356.73	0.000711
DFSPFLXA	PNLNFLXA	\$ 124.39	\$ 3,247.36	0.000711
ORCYFLXC	LKHNFLXA	\$ 71.95	\$ 1,771.38	0.000711
ORCYFLXC	ORCYFLXA	\$ 71.95	\$ 1,771.38	0.000711
DESTFLXA	FTWBFLXA	\$ 86.39	\$ 1,178.36	0.000711
DESTFLXA	VLPRFLXA	\$ 86.39	\$ 1,178.36	0.000711
DESTFLXA	SNRSFLXA	\$ 86.39	\$ 1,178.36	0.000711
DESTFLXA	SHLMFLXA	\$ 86.39	\$ 1,178.36	0.000711
DESTFLXA	VLPRFLXA	\$ 86.39	\$ 1,178.36	0.000711

FTMYFLXB	RGAPFLXA	\$ 158.34	\$ 2,949.75	0.000711
FTMYFLXB	FTMYFLXA	\$ 86.39	\$ 1,178.36	0.000711
FTMYFLXB	FTMBFLXA	\$ 71.95	\$ 1,178.36	0.000711
FTMYFLXB	LHACFLXA	\$ 86.39	\$ 1,178.36	0.000711
FTMYFLXB	CPCRFLXB	\$ 136.41	\$ 2,771.35	0.000711
FTMYFLXB	NFMYFLXA	\$ 136.41	\$ 2,771.35	0.000711
FTMYFLXB	PNISFLXA	\$ 71.95	\$ 1,178.36	0.000711
FTMYFLXB	SNISFLXA	\$ 71.95	\$ 1,178.36	0.000711
FTMYFLXB	FTMYFLXC	\$ 86.39	\$ 1,178.36	0.000711
ESTSFLXA	GVLDFLXA	\$ 202.19	\$ 3,832.70	0.000711
ESTSFLXA	HOWYFLXA	\$ 210.77	\$ 4,425.72	0.000711
ESTSFLXA	LDLKFLXA	\$ 149.76	\$ 2,949.75	0.000711
ESTSFLXA	LSBGFLXA	\$ 86.39	\$ 1,178.36	0.000711
ESTSFLXA	MTVRFLXA	\$ 210.77	\$ 4,425.72	0.000711
ESTSFLXA	MTDRFLXA	\$ 86.39	\$ 1,178.36	0.000711
ESTSFLXA	TVRSFLXA	\$ 86.39	\$ 1,178.36	0.000711
ESTSFLXA	UMTLFLXA	\$ 86.39	\$ 1,178.36	0.000711
OCNFFLXA	CITRFLXA	\$ 326.58	\$ 7,080.06	0.000711
OCNFFLXA	DNLNFLXA	\$ 363.56	\$ 8,258.42	0.000711
OCNFFLXA	OCALFLXC	\$ 138.82	\$ 3,247.36	0.000711
OCNFFLXA	LDLKFLXB	\$ 307.76	\$ 7,375.47	0.000711
OCNFFLXA	MCINFLXA	\$ 326.58	\$ 7,080.06	0.000711
OCNFFLXA	OCALFLXA	\$ 202.19	\$ 4,425.72	0.000711
OCNFFLXA	OKLWFLXA	\$ 247.76	\$ 5,604.09	0.000711
OCNFFLXA	ORSPFLXA	\$ 326.58	\$ 7,080.06	0.000711
OCNFFLXA	SSPRFLXA	\$ 345.60	\$ 8,760.35	0.000711
OCNFFLXA	SVSSFLXA	\$ 247.76	\$ 5,604.09	0.000711
FTMDFLXA	BARTFLXA	\$ 71.95	\$ 1,178.36	0.000711
FTMDFLXA	LKLDLFLXA	\$ 71.95	\$ 1,178.36	0.000711
RGAPFLXA	FTMYFLXC	\$ 158.34	\$ 2,949.75	0.000711
FTMYFLXA	FTMBFLXA	\$ 71.95	\$ 1,178.36	0.000711
FTMYFLXA	LHACFLXA	\$ 86.39	\$ 1,178.36	0.000711
FTMYFLXA	CPCRFLXB	\$ 136.41	\$ 2,771.35	0.000711
FTMYFLXA	NFMYFLXA	\$ 136.41	\$ 2,771.35	0.000711
FTMYFLXA	PNISFLXA	\$ 71.95	\$ 1,178.36	0.000711
FTMYFLXA	SNISFLXA	\$ 71.95	\$ 1,178.36	0.000711
FTMBFLXA	LHACFLXA	\$ 131.95	\$ 2,356.73	0.000711
FTMBFLXA	CPCRFLXB	\$ 174.82	\$ 3,949.71	0.000711
FTMBFLXA	NFMYFLXA	\$ 71.95	\$ 1,178.36	0.000711
FTMBFLXA	PNISFLXA	\$ 71.95	\$ 1,178.36	0.000711
FTMBFLXA	SNISFLXA	\$ 71.95	\$ 1,178.36	0.000711
FTWBFLXA	HLNVFLMA *	\$ 71.95	\$ 1,178.36	0.000711
FTWBFLXA	VLPRFLXA	\$ 86.39	\$ 1,178.36	0.000711
FTWBFLXA	SNRSFLXA	\$ 149.76	\$ 2,356.73	0.000711

FTWBFLXA	SHLMFLXA	\$ 86.39	\$ 1,178.36	0.000711
FTWBFLXA	VLPFLXA	\$ 86.39	\$ 1,178.36	0.000711
GLGCFLXA	MOISFLXA	\$ 86.39	\$ 1,178.36	0.000711
GLGCFLXA	NPLSFLXA	\$ 86.39	\$ 1,178.36	0.000711
GLGCFLXA	NPLSFLXD	\$ 86.39	\$ 1,178.36	0.000711
GLGCFLXA	NPLSFLXC	\$ 86.39	\$ 1,178.36	0.000711
GLGCFLXA	NNPLFLXA	\$ 86.39	\$ 1,178.36	0.000711
GLRDFLXA	CLBRFLAD	\$ 174.14	\$ 3,535.09	0.000711
GLRDFLXA	EORNFLXA	\$ 131.95	\$ 2,356.73	0.000711
GLRDFLXA	GENVFLXA	\$ 131.95	\$ 2,356.73	0.000711
GLRDFLXA	LKBRFLXA	\$ 131.95	\$ 2,356.73	0.000711
GLRDFLXA	LKBNFLXA	\$ 174.14	\$ 3,535.09	0.000711
GLRDFLXA	MTLDFLXA	\$ 131.95	\$ 2,356.73	0.000711
GLRDFLXA	MTVRFLXA	\$ 256.34	\$ 5,604.09	0.000711
GLRDFLXA	ORLDFLXA	\$ 131.95	\$ 2,356.73	0.000711
GLRDFLXA	OVIDFLCA	\$ 131.95	\$ 2,356.73	0.000711
GLRDFLXA	KSSMFLXC	\$ 191.95	\$ 3,535.09	0.000711
GLRDFLXA	SNFRFLMA	\$ 131.95	\$ 2,356.73	0.000711
GLRDFLXA	WNDRFLXA	\$ 191.95	\$ 3,535.09	0.000711
GLRDFLXA	WNGRFLXA	\$ 131.95	\$ 2,356.73	0.000711
GLRDFLXA	WNPFLXA	\$ 86.39	\$ 1,178.36	0.000711
GDRGFLXA	MRNNFLXA	\$ 86.39	\$ 1,178.36	0.000711
GDRGFLXA	SNDSFLXA	\$ 86.39	\$ 1,178.36	0.000711
GNVFLXA	LEE_FLXA	\$ 196.34	\$ 5,018.74	0.000711
GNVFLXA	MDSNFLXA	\$ 124.39	\$ 3,247.36	0.000711
GNVFLXA	MNTIFLXA	\$ 138.82	\$ 2,654.34	0.000711
GNVFLXA	TLHSFLXA	\$ 138.82	\$ 2,654.34	0.000711
GNWDFLXA	MALNFLXA	\$ 86.39	\$ 1,178.36	0.000711
GNWDFLXA	MRNNFLXA	\$ 86.39	\$ 1,178.36	0.000711
GVLDFLXA	HOWYFLXA	\$ 263.21	\$ 5,901.70	0.000711
GVLDFLXA	LDLFLXA	\$ 202.19	\$ 4,425.72	0.000711
GVLDFLXA	LSBGFLXA	\$ 138.82	\$ 2,654.34	0.000711
GVLDFLXA	MTVRFLXA	\$ 326.58	\$ 7,080.06	0.000711
GVLDFLXA	MTDRFLXA	\$ 202.19	\$ 3,832.70	0.000711
GVLDFLXA	TVRSFLXA	\$ 202.19	\$ 3,832.70	0.000711
GVLDFLXA	UMTLFLXA	\$ 318.00	\$ 7,080.06	0.000711
OCALFLXC	CITRFLXA	\$ 210.77	\$ 3,832.70	0.000711
OCALFLXC	DNLNFLXA	\$ 247.76	\$ 5,011.07	0.000711
OCALFLXC	LDLFLXB	\$ 149.76	\$ 2,949.75	0.000711
OCALFLXC	MCINFLXA	\$ 210.77	\$ 3,832.70	0.000711
OCALFLXC	OCALFLXA	\$ 86.39	\$ 1,178.36	0.000711
OCALFLXC	OKLWFLXA	\$ 131.95	\$ 2,356.73	0.000711
OCALFLXC	ORSPFLXA	\$ 210.77	\$ 3,832.70	0.000711
OCALFLXC	SSPRFLXA	\$ 408.97	\$ 9,938.72	0.000711

OCALFLXC	OCALFLXB	\$ 138.82	\$ 2,654.34	0.000711
OCALFLXC	SVSPFLXA	\$ 71.95	\$ 1,771.38	0.000711
OCALFLXC	SVSSFLXA	\$ 131.95	\$ 2,356.73	0.000711
HMSPFLEXA	INVRFLXA	\$ 188.84	\$ 3,247.36	0.000711
HOWYFLXA	LDLKFLXA	\$ 210.77	\$ 5,018.74	0.000711
HOWYFLXA	LSBGFLXA	\$ 210.77	\$ 4,425.72	0.000711
HOWYFLXA	MTVRFLXA	\$ 335.16	\$ 7,673.08	0.000711
HOWYFLXA	MTDRFLXA	\$ 210.77	\$ 4,425.72	0.000711
HOWYFLXA	TVRSFLXA	\$ 210.77	\$ 4,425.72	0.000711
HOWYFLXA	UMTLFLXA	\$ 326.58	\$ 7,673.08	0.000711
KNVLFLXA	KSSMFLXA	\$ 138.82	\$ 2,654.34	0.000711
KNVLFLXA	STCDFLXA	\$ 138.82	\$ 2,654.34	0.000711
KNVLFLXA	KSSMFLXB	\$ 184.39	\$ 3,832.70	0.000711
KGLKFLXA	LWTYFLXA	\$ 206.77	\$ 5,512.99	0.000711
KGLKFLXA	RAFRLAB	\$ 278.72	\$ 6,691.36	0.000711
KGLKFLXA	STRKFLXA	\$ 206.77	\$ 5,512.99	0.000711
KSSMFLXA	CLBRFLAD	\$ 114.14	\$ 2,356.73	0.000711
KSSMFLXA	HNCYFLXA	\$ 138.82	\$ 2,654.34	0.000711
KSSMFLXA	STCDFLXA	\$ 138.82	\$ 2,654.34	0.000711
KSSMFLXA	KSSMFLXB	\$ 71.95	\$ 1,178.36	0.000711
LDLKFLXA	LSBGFLXA	\$ 86.39	\$ 1,771.38	0.000711
LDLKFLXA	MTVRFLXA	\$ 274.14	\$ 6,197.11	0.000711
LDLKFLXA	MTDRFLXA	\$ 149.76	\$ 2,949.75	0.000711
LDLKFLXA	TVRSFLXA	\$ 149.76	\$ 2,949.75	0.000711
LDLKFLXA	UMTLFLXA	\$ 265.56	\$ 6,197.11	0.000711
LDLKFLXB	LSBGFLXA	\$ 86.39	\$ 1,771.38	0.000711
LDLKFLXB	MTVRFLXA	\$ 274.14	\$ 6,197.11	0.000711
LDLKFLXB	MTDRFLXA	\$ 149.76	\$ 2,949.75	0.000711
LDLKFLXB	OCALFLXA	\$ 202.19	\$ 4,425.72	0.000711
LDLKFLXB	OKLWFLXA	\$ 131.95	\$ 2,949.75	0.000711
LDLKFLXB	SSPRFLXA	\$ 514.53	\$ 12,888.46	0.000711
LDLKFLXB	SVSSFLXA	\$ 131.95	\$ 2,949.75	0.000711
LDLKFLXB	TVRSFLXA	\$ 149.76	\$ 2,949.75	0.000711
LDLKFLXB	UMTLFLXA	\$ 265.56	\$ 6,197.11	0.000711
LKBRFLXA	CLBRFLAD	\$ 156.33	\$ 3,535.09	0.000711
LKBRFLXA	EORNFLXA	\$ 114.14	\$ 2,356.73	0.000711
LKBRFLXA	GENVFLXA	\$ 114.14	\$ 2,356.73	0.000711
LKBRFLXA	LKBNFLXA	\$ 156.33	\$ 3,535.09	0.000711
LKBRFLXA	MTLDFLXA	\$ 71.95	\$ 1,178.36	0.000711
LKBRFLXA	MTVRFLXA	\$ 238.53	\$ 5,604.09	0.000711
LKBRFLXA	ORLDFLXA	\$ 114.14	\$ 2,356.73	0.000711
LKBRFLXA	OVIDFLCA	\$ 114.14	\$ 2,356.73	0.000711
LKBRFLXA	KSSMFLXC	\$ 174.14	\$ 3,535.09	0.000711
LKBRFLXA	SNFRFLMA	\$ 114.14	\$ 2,356.73	0.000711

LKBRFLXA	WNDRFLXA	\$ 174.14	\$ 3,535.09	0.000711
LKBRFLXA	WNGRFLXA	\$ 114.14	\$ 2,356.73	0.000711
LKBRFLXA	WNPFLXA	\$ 71.95	\$ 1,178.36	0.000711
LKHNFLXA	ORCYFLXA	\$ 71.95	\$ 1,771.38	0.000711
LWTYFLXA	RAFRFLAB	\$ 278.72	\$ 6,691.36	0.000711
LWTYFLXA	STRKFLXA	\$ 206.77	\$ 5,512.99	0.000711
LEE_FLXA	MDSNFLXA	\$ 71.95	\$ 1,771.38	0.000711
LSBGFLXA	MTVRFLXA	\$ 210.77	\$ 4,425.72	0.000711
LSBGFLXA	MTDRFLXA	\$ 86.39	\$ 1,178.36	0.000711
LSBGFLXA	TVRSFLXA	\$ 86.39	\$ 1,178.36	0.000711
LSBGFLXA	UMTLFLXA	\$ 202.19	\$ 4,425.72	0.000711
MTLDFLXA	CLBRFLAD	\$ 156.33	\$ 3,535.09	0.000711
MTLDFLXA	EORNFLXA	\$ 114.14	\$ 2,356.73	0.000711
MTLDFLXA	GENVFLXA	\$ 114.14	\$ 2,356.73	0.000711
MTLDFLXA	LKBNFLXA	\$ 156.33	\$ 3,535.09	0.000711
MTLDFLXA	MTVRFLXA	\$ 238.53	\$ 5,604.09	0.000711
MTLDFLXA	ORLDFLXA	\$ 114.14	\$ 2,356.73	0.000711
MTLDFLXA	OVIDFLCA	\$ 114.14	\$ 2,356.73	0.000711
MTLDFLXA	KSSMFLXC	\$ 174.14	\$ 3,535.09	0.000711
MTLDFLXA	SNFRFLMA	\$ 114.14	\$ 2,356.73	0.000711
MTLDFLXA	WNDRFLXA	\$ 174.14	\$ 3,535.09	0.000711
MTLDFLXA	WNGRFLXA	\$ 114.14	\$ 2,356.73	0.000711
MTLDFLXA	WNPFLXA	\$ 71.95	\$ 1,178.36	0.000711
MALNFLXA	MRNNFLXA	\$ 86.39	\$ 1,178.36	0.000711
MOISFLXA	NPLSFLXA	\$ 86.39	\$ 1,178.36	0.000711
MOISFLXA	NPLSFLXD	\$ 86.39	\$ 1,178.36	0.000711
MOISFLXA	NPLSFLXC	\$ 86.39	\$ 1,178.36	0.000711
MOISFLXA	NNPLFLXA	\$ 86.39	\$ 1,178.36	0.000711
MRNNFLXA	ALTHFLXA	\$ 71.95	\$ 1,178.36	0.000711
MRNNFLXA	SNDSFLXA	\$ 86.39	\$ 1,178.36	0.000711
MNTIFLXA	TLHSFLXA	\$ 138.82	\$ 2,654.34	0.000711
MTVRFLXA	CLBRFLAD	\$ 256.34	\$ 5,604.09	0.000711
MTVRFLXA	EORNFLXA	\$ 238.53	\$ 5,604.09	0.000711
MTVRFLXA	LKBNFLXA	\$ 256.34	\$ 5,604.09	0.000711
MTVRFLXA	MTDRFLXA	\$ 210.77	\$ 4,425.72	0.000711
MTVRFLXA	ORLDFLXA	\$ 238.53	\$ 5,604.09	0.000711
MTVRFLXA	KSSMFLXC	\$ 210.77	\$ 4,425.72	0.000711
MTVRFLXA	TVRSFLXA	\$ 210.77	\$ 4,425.72	0.000711
MTVRFLXA	UMTLFLXA	\$ 210.77	\$ 4,425.72	0.000711
MTVRFLXA	WNDRFLXA	\$ 210.77	\$ 4,425.72	0.000711
MTVRFLXA	WNGRFLXA	\$ 124.39	\$ 3,247.36	0.000711
MTVRFLXA	WNPFLXA	\$ 196.34	\$ 4,425.72	0.000711
MTDRFLXA	TVRSFLXA	\$ 86.39	\$ 1,178.36	0.000711
MTDRFLXA	UMTLFLXA	\$ 202.19	\$ 4,425.72	0.000711

NPLSFLXA	NPLSFLXC	\$ 86.39	\$ 1,178.36	0.000711
NPLSFLXA	NNPLFLXA	\$ 86.39	\$ 1,178.36	0.000711
NPLSFLXD	NPLSFLXC	\$ 86.39	\$ 1,178.36	0.000711
NPLSFLXD	NNPLFLXA	\$ 86.39	\$ 1,178.36	0.000711
NPLSFLXC	NNPLFLXA	\$ 86.39	\$ 1,178.36	0.000711
VLPRFLXA	SHLMFLXA	\$ 86.39	\$ 1,178.36	0.000711
CPCRFLXB	NFMYFLXA	\$ 136.41	\$ 2,771.35	0.000711
CPCRFLXB	PNISFLXA	\$ 174.82	\$ 3,949.71	0.000711
CPCRFLXB	SNISFLXA	\$ 174.82	\$ 3,949.71	0.000711
NFMYFLXA	PNISFLXA	\$ 71.95	\$ 1,178.36	0.000711
NFMYFLXA	SNISFLXA	\$ 71.95	\$ 1,178.36	0.000711
OCALFLXA	CITRFLXA	\$ 263.21	\$ 5,308.68	0.000711
OCALFLXA	DNLNFLXA	\$ 184.39	\$ 3,832.70	0.000711
OCALFLXA	MCINFLXA	\$ 263.21	\$ 5,308.68	0.000711
OCALFLXA	OKLWFLXA	\$ 71.95	\$ 1,178.36	0.000711
OCALFLXA	ORSPFLXA	\$ 263.21	\$ 5,308.68	0.000711
OCALFLXA	SSPRFLXA	\$ 408.97	\$ 9,938.72	0.000711
OCALFLXA	OCALFLXB	\$ 138.82	\$ 2,654.34	0.000711
OCALFLXA	SVSPFLXA	\$ 158.34	\$ 2,949.75	0.000711
OCALFLXA	SVSSFLXA	\$ 71.95	\$ 1,178.36	0.000711
OKLWFLXA	CITRFLXA	\$ 196.34	\$ 3,832.70	0.000711
OKLWFLXA	DNLNFLXA	\$ 229.95	\$ 5,011.07	0.000711
OKLWFLXA	MCINFLXA	\$ 196.34	\$ 3,832.70	0.000711
OKLWFLXA	ORSPFLXA	\$ 196.34	\$ 3,832.70	0.000711
OKLWFLXA	SSPRFLXA	\$ 454.53	\$ 11,117.08	0.000711
OKLWFLXA	SVSSFLXA	\$ 71.95	\$ 1,178.36	0.000711
ORCYFLXA	DBRYFLXA	\$ 71.95	\$ 1,178.36	0.000711
ORCYFLXA	DELDFLXA	\$ 71.95	\$ 1,178.36	0.000711
ORCYFLXA	DLSPFLXA	\$ 71.95	\$ 1,178.36	0.000711
PNACFLXA	ARPNFLXA	\$ 628.66	\$ 15,068.99	0.000711
PNACFLXA	SPCPFLXA	\$ 395.62	\$ 9,760.31	0.000711
PNACFLXA	STMKFLXA	\$ 248.78	\$ 6,494.72	0.000711
PNACFLXA	TLHSFLXD	\$ 395.62	\$ 9,760.31	0.000711
PNISFLXA	SNISFLXA	\$ 71.95	\$ 1,178.36	0.000711
KSSMFLXC	CLBRFLAD	\$ 131.95	\$ 2,356.73	0.000711
KSSMFLXC	EORNFLXA	\$ 174.14	\$ 3,535.09	0.000711
KSSMFLXC	LKBNFLXA	\$ 131.95	\$ 2,356.73	0.000711
KSSMFLXC	ORLDFLXA	\$ 174.14	\$ 3,535.09	0.000711
KSSMFLXC	KSSMFLXB	\$ 86.39	\$ 1,178.36	0.000711
KSSMFLXC	WNDRFLXA	\$ 149.76	\$ 2,356.73	0.000711
KSSMFLXC	WNGRFLXA	\$ 86.39	\$ 1,178.36	0.000711
KSSMFLXC	WNPKFLXA	\$ 131.95	\$ 2,356.73	0.000711
RYHLFLXA	WSTVFLXA	\$ 196.34	\$ 5,018.74	0.000711
SSPRFLXA	CITRFLXA	\$ 533.35	\$ 12,593.05	0.000711

SSPRFLXA	DNLNFLXA	\$ 570.34	\$ 13,771.42	0.000711
SSPRFLXA	MCINFLXA	\$ 533.35	\$ 12,593.05	0.000711
SSPRFLXA	ORSPFLXA	\$ 533.35	\$ 12,593.05	0.000711
SSPRFLXA	SVSSFLXA	\$ 454.53	\$ 11,117.08	0.000711
SNANFLXA	TLCHFLXA	\$ 149.76	\$ 2,356.73	0.000711
SNANFLXA	ZPHYFLXA	\$ 131.95	\$ 2,356.73	0.000711
SNRSFLXA	SGBHFLXA	\$ 86.39	\$ 1,178.36	0.000711
SBNGFLXA	SLHLFLXA	\$ 124.39	\$ 2,654.34	0.000711
SHLMFLXA	VLPRFLXA	\$ 86.39	\$ 1,178.36	0.000711
SVSSFLXA	CITRFLXA	\$ 196.34	\$ 3,832.70	0.000711
SVSSFLXA	DNLNFLXA	\$ 229.95	\$ 5,011.07	0.000711
SVSSFLXA	MCINFLXA	\$ 196.34	\$ 3,832.70	0.000711
SVSSFLXA	ORSPFLXA	\$ 196.34	\$ 3,832.70	0.000711
SPCPFLXA	ARNPFLXA *	\$ 504.27	\$ 11,821.63	0.000711
SPCPFLXA	CRBLFLXA	\$ 504.27	\$ 11,821.63	0.000711
SPCPFLXA	STMKFLXA	\$ 395.62	\$ 9,760.31	0.000711
SPCPFLXA	TLHSFLXD	\$ 271.23	\$ 6,512.95	0.000711
STCDFLXA	CLBRFLAD	\$ 114.14	\$ 2,356.73	0.000711
STCDFLXA	KSSMFLXB	\$ 71.95	\$ 1,178.36	0.000711
STMKFLXA	ARNPFLXA •	\$ 628.66	\$ 15,068.99	0.000711
STMKFLXA	TLHSFLXD	\$ 395.62	\$ 9,760.31	0.000711
STRKFLXA	KYHGFLMA •	\$ 278.72	\$ 6,691.36	0.000711
STRKFLXA	RAFRFLAB	\$ 278.72	\$ 6,691.36	0.000711
TLHSFLXA	ARNPFLXA •	\$ 263.21	\$ 5,308.68	0.000711
TLHSFLXA	BRSTFLXA	\$ 131.95	\$ 2,356.73	0.000711
TLHSFLXA	CRBLFLXA	\$ 263.21	\$ 5,308.68	0.000711
TLHSFLXA	CHTHFLXA	\$ 263.21	\$ 5,308.68	0.000711
TLHSFLXA	GNBOFLXA	\$ 131.95	\$ 2,356.73	0.000711
TLHSFLXA	GRETFLXA	\$ 131.95	\$ 2,356.73	0.000711
TLHSFLXA	HAVNFLMA	\$ 131.95	\$ 2,356.73	0.000711
TLHSFLXA	HSFRFLXA •	\$ 131.95	\$ 2,356.73	0.000711
TLHSFLXA	PRRYFLXA*	\$ 263.21	\$ 5,308.68	0.000711
TLHSFLXA	QNCYFLXA	\$ 131.95	\$ 2,356.73	0.000711
TLHSFLXA	TLHSFLXE	\$ 86.39	\$ 1,178.36	0.000711
TLHSFLXA	TLHSFLXC	\$ 86.39	\$ 1,178.36	0.000711
TLHSFLXA	TLHSFLXH	\$ 86.39	\$ 1,178.36	0.000711
TLHSFLXA	TLHSFLXB	\$ 86.39	\$ 1,178.36	0.000711
TLHSFLXA	TLHSFLXF	\$ 149.76	\$ 2,356.73	0.000711
TLHSFLXE	ARNPFLXA •	\$ 326.58	\$ 6,487.04	0.000711
TLHSFLXE	BRSTFLXA	\$ 131.95	\$ 2,356.73	0.000711
TLHSFLXE	CRBLFLXA	\$ 326.58	\$ 6,487.04	0.000711
TLHSFLXE	CHTHFLXA	\$ 326.58	\$ 6,487.04	0.000711
TLHSFLXE	GNBOFLXA	\$ 131.95	\$ 2,356.73	0.000711
TLHSFLXE	GRETFLXA	\$ 131.95	\$ 2,356.73	0.000711

TLHSFLXE	HAVNFLMA	\$ 131.95	\$ 2,356.73	0.000711
TLHSFLXE	HSFRFLXA *	\$ 131.95	\$ 2,356.73	0.000711
TLHSFLXE	QNCYFLXA	\$ 131.95	\$ 2,356.73	0.000711
TLHSFLXE	TLHSFLXC	\$ 86.39	\$ 1,178.36	0.000711
TLHSFLXE	TLHSFLXH	\$ 86.39	\$ 1,178.36	0.000711
TLHSFLXE	TLHSFLXB	\$ 86.39	\$ 1,178.36	0.000711
TLHSFLXE	TLHSFLXF	\$ 149.76	\$ 2,356.73	0.000711
TLHSFLXC	ARNFLXA *	\$ 326.58	\$ 6,487.04	0.000711
TLHSFLXC	BRSTFLXA	\$ 131.95	\$ 2,356.73	0.000711
TLHSFLXC	CRBLFLXA	\$ 326.58	\$ 6,487.04	0.000711
TLHSFLXC	CHTHFLXA	\$ 326.58	\$ 6,487.04	0.000711
TLHSFLXC	GNBOFLXA	\$ 131.95	\$ 2,356.73	0.000711
TLHSFLXC	GRETFLXA	\$ 131.95	\$ 2,356.73	0.000711
TLHSFLXC	HAVNFLMA	\$ 131.95	\$ 2,356.73	0.000711
TLHSFLXC	HSFRFLXA *	\$ 131.95	\$ 2,356.73	0.000711
TLHSFLXC	QNCYFLXA	\$ 131.95	\$ 2,356.73	0.000711
TLHSFLXC	TLHSFLXH	\$ 86.39	\$ 1,178.36	0.000711
TLHSFLXC	TLHSFLXB	\$ 86.39	\$ 1,178.36	0.000711
TLHSFLXC	TLHSFLXF	\$ 149.76	\$ 2,356.73	0.000711
TLHSFLXH	ARNFLXA *	\$ 326.58	\$ 6,487.04	0.000711
TLHSFLXH	BRSTFLXA	\$ 131.95	\$ 2,356.73	0.000711
TLHSFLXH	CRBLFLXA	\$ 326.58	\$ 6,487.04	0.000711
TLHSFLXH	CHTHFLXA	\$ 326.58	\$ 6,487.04	0.000711
TLHSFLXH	GNBOFLXA	\$ 131.95	\$ 2,356.73	0.000711
TLHSFLXH	GRETFLXA	\$ 131.95	\$ 2,356.73	0.000711
TLHSFLXH	HAVNFLMA	\$ 131.95	\$ 2,356.73	0.000711
TLHSFLXH	HSFRFLXA *	\$ 131.95	\$ 2,356.73	0.000711
TLHSFLXH	QNCYFLXA	\$ 131.95	\$ 2,356.73	0.000711
TLHSFLXH	TLHSFLXB	\$ 86.39	\$ 1,178.36	0.000711
TLHSFLXH	TLHSFLXF	\$ 149.76	\$ 2,356.73	0.000711
TLHSFLXB	ARNFLXA *	\$ 326.58	\$ 6,487.04	0.000711
TLHSFLXB	BRSTFLXA	\$ 71.95	\$ 1,178.36	0.000711
TLHSFLXB	CRBLFLXA	\$ 326.58	\$ 6,487.04	0.000711
TLHSFLXB	CHTHFLXA	\$ 326.58	\$ 6,487.04	0.000711
TLHSFLXB	GNBOFLXA	\$ 71.95	\$ 1,178.36	0.000711
TLHSFLXB	GRETFLXA	\$ 71.95	\$ 1,178.36	0.000711
TLHSFLXB	HAVNFLMA	\$ 71.95	\$ 1,178.36	0.000711
TLHSFLXB	HSFRFLXA *	\$ 71.95	\$ 1,178.36	0.000711
TLHSFLXB	QNCYFLXA	\$ 71.95	\$ 1,178.36	0.000711
TLHSFLXD	ARNFLXA *	\$ 326.58	\$ 6,487.04	0.000711
TLHSFLXD	BRSTFLXA	\$ 131.95	\$ 2,356.73	0.000711
TLHSFLXD	CRBLFLXA	\$ 326.58	\$ 6,487.04	0.000711
TLHSFLXD	CHTHFLXA	\$ 326.58	\$ 6,487.04	0.000711
TLHSFLXD	GNBOFLXA	\$ 131.95	\$ 2,356.73	0.000711

TLHSFLXD	GRETFLXA	\$ 131.95	\$ 2,356.73	0.000711
TLHSFLXD	HAVNFLMA	\$ 131.95	\$ 2,356.73	0.000711
TLHSFLXD	HSFRFLXA *	\$ 131.95	\$ 2,356.73	0.000711
TLHSFLXD	QNCYFLXA	\$ 131.95	\$ 2,356.73	0.000711
TLHSFLXD	TLHSFLXA	\$ 86.39	\$ 1,178.36	0.000711
TLHSFLXD	TLHSFLXE	\$ 149.76	\$ 2,356.73	0.000711
TLHSFLXD	TLHSFLXC	\$ 86.39	\$ 1,178.36	0.000711
TLHSFLXD	TLHSFLXH	\$ 149.76	\$ 2,356.73	0.000711
TLHSFLXD	TLHSFLXB	\$ 86.39	\$ 1,178.36	0.000711
TLHSFLXD	TLHSFLXF	\$ 149.76	\$ 2,356.73	0.000711
TLHSFLXF	ARPNFLXA *	\$ 389.95	\$ 7,665.40	0.000711
TLHSFLXF	BRSTFLXA	\$ 131.95	\$ 2,356.73	0.000711
TLHSFLXF	CRBLFLXA	\$ 389.95	\$ 7,665.40	0.000711
TLHSFLXF	CHTHFLXA	\$ 389.95	\$ 7,665.40	0.000711
TLHSFLXF	GNBOFLXA	\$ 131.95	\$ 2,356.73	0.000711
TLHSFLXF	GRETFLXA	\$ 131.95	\$ 2,356.73	0.000711
TLHSFLXF	HAVNFLMA	\$ 131.95	\$ 2,356.73	0.000711
TLHSFLXF	HSFRFLXA *	\$ 131.95	\$ 2,356.73	0.000711
TLHSFLXF	QNCYFLXA	\$ 131.95	\$ 2,356.73	0.000711
TLHSFLXF	TLHSFLXB	\$ 86.39	\$ 1,178.36	0.000711
TVRSFLXA	UMTLFLXA	\$ 202.19	\$ 4,425.72	0.000711
TLCHFLXA	ZPHYFLXA	\$ 131.95	\$ 2,356.73	0.000711
WCHLFLXA	ZLSPFLXA	\$ 124.39	\$ 2,654.34	0.000711
KSSMFLXB	CLBRFLAD	\$ 71.95	\$ 1,178.36	0.000711
KSSMFLXB	HNCYFLXA	\$ 184.39	\$ 3,832.70	0.000711
WLSTFLXA	BRSNFLMA	\$ 71.95	\$ 1,178.36	0.000711
WNDRFLXA	CLBRFLAD	\$ 174.14	\$ 3,535.09	0.000711
WNDRFLXA	EORNFLXA	\$ 174.14	\$ 3,535.09	0.000711
WNDRFLXA	LKBNFLXA	\$ 174.14	\$ 3,535.09	0.000711
WNDRFLXA	ORLDFLXA	\$ 174.14	\$ 3,535.09	0.000711
WNDRFLXA	WNGRFLXA	\$ 86.39	\$ 1,178.36	0.000711
WNDRFLXA	WNPKFLXA	\$ 131.95	\$ 2,356.73	0.000711
WNGRFLXA	CLBRFLAD	\$ 131.95	\$ 2,356.73	0.000711
WNGRFLXA	EORNFLXA	\$ 114.14	\$ 2,356.73	0.000711
WNGRFLXA	LKBNFLXA	\$ 131.95	\$ 2,356.73	0.000711
WNGRFLXA	ORLDFLXA	\$ 114.14	\$ 2,356.73	0.000711
WNGRFLXA	WNPKFLXA	\$ 71.95	\$ 1,178.36	0.000711
WNPKFLXA	CLBRFLAD	\$ 114.14	\$ 2,356.73	0.000711
WNPKFLXA	EORNFLXA	\$ 71.95	\$ 1,178.36	0.000711
WNPKFLXA	GENVFLXA	\$ 71.95	\$ 1,178.36	0.000711
WNPKFLXA	LKBNFLXA	\$ 114.14	\$ 2,356.73	0.000711
WNPKFLXA	ORLDFLXA	\$ 71.95	\$ 1,178.36	0.000711
WNPKFLXA	OVIDFLCA	\$ 71.95	\$ 1,178.36	0.000711
WNPKFLXA	SNFRFLMA	\$ 71.95	\$ 1,178.36	0.000711

WNPKFLXA

WNPKFLXE

\$ 71.95

ICB

0.000711

ATTACHMENT II
LOCAL RESALE

1. TELECOMMUNICATIONS SERVICES PROVIDED FOR RESALE

- 1.1. At the request of CLEC, and pursuant to the requirements of the Act, and FCC and Commission Rules and Regulations, Sprint shall make available to CLEC for resale Telecommunications Services that Sprint currently provides or may provide hereafter at retail to subscribers who are not telecommunications carriers. Such resale may be as allowed by the FCC and Commission. The Telecommunications Services provided by Sprint to CLEC pursuant to this Attachment II are collectively referred to as "Local Resale."
- 1.2. To the extent that this Attachment describes services which Sprint shall make available to CLEC for resale pursuant to this Agreement, this list of services is neither all inclusive nor exclusive.

2. GENERAL TERMS AND CONDITIONS

- 2.1. Pricing. The prices charged to CLEC for Local Resale are set forth in Attachment I of this Agreement.
 - 2.1.1. CENTREX Requirements
 - 2.1.1.1. At CLEC's option, CLEC may purchase the entire set of CENTREX features or a subset of any such features.
 - 2.1.1.2. All features and functions of CENTREX Service, including CENTREX Management System (CMS), whether offered under tariff or otherwise, shall be available to CLEC for resale.
 - 2.1.1.3. Sprint shall make information required for an "as is" transfer of CENTREX subscriber service, features, functionalities and CMS capabilities available to CLEC.
 - 2.1.1.4. Consistent with Sprint's tariffs, CLEC, at its expense, may collect all data and aggregate the CENTREX local exchange, and IntraLATA traffic usage of CLEC subscribers to qualify for volume discounts on the basis of such aggregated usage.
 - 2.1.1.5. CLEC may request that Sprint suppress the need for CLEC subscribers to dial "9" when placing calls outside the CENTREX System. Should CLEC request this capability for its subscriber, the subscriber will not be able to use 4-digit dialing.
 - 2.1.1.6. CLEC may resell call forwarding in conjunction with CENTREX Service.

- 2.1.1.7. CLEC may purchase any CENTREX Service for resale subject to the requirements of Sprint's tariff.
- 2.1.1.8. Sprint shall make available to CLEC for resale intercom calling within the same CENTREX system. To the extent that Sprint offers its own subscribers intercom calling between different CENTREX systems, Sprint shall make such capability available to CLEC for resale.
- 2.1.1.9. CLEC may resell Automatic Route Selection ("ARS"). CLEC may aggregate multiple CLEC subscribers on dedicated access facilities where such aggregation is allowed by law, rule or regulation.
- 2.1.2. Voluntary Federal and State Subscriber Financial Assistance Programs
 - 2.1.2.1. Subsidized local Telecommunications Services are provided to low-income subscribers pursuant to requirements established by the appropriate state regulatory body, and include programs such as Voluntary Federal Subscriber Financial Assistance Program and Link-Up America. Voluntary Federal and State Subscriber Financial Assistance Programs are not Telecommunications Services that are available for resale under this Agreement. However, when a Sprint subscriber who is eligible for such a federal program or other similar state program chooses to obtain Local Resale from CLEC and CLEC serves such subscriber via Local Resale, Sprint shall identify such subscriber's eligibility to participate in such programs to CLEC in accordance with the procedures set forth herein.
- 2.1.3. Grandfathered Services. Sprint shall offer for resale to CLEC all Grandfathered Services solely for the existing grandfathered base on a customer specific basis. Sprint shall make reasonable efforts to provide CLEC with advance copy of any request for the termination of service and/or grandfathering to be filed by Sprint with the Commission.
- 2.1.4. Contract Service Arrangements, Special Arrangements, and Promotions. Sprint shall offer for resale all of its Telecommunications Services available at retail to subscribers who are not Telecommunications Carriers, including but not limited to Contract Service Arrangements (or ICB), Special Arrangements (or ICB), and Promotions in excess of ninety (90) days, all in accordance with FCC and Commission Rules and Regulations.
- 2.1.5. COCOT lines will not be resold at wholesale prices under this Agreement.
- 2.1.6. Hospitality Service. Sprint shall provide all blocking, screening, and all other applicable functions available for hospitality lines under tariff.
- 2.1.7. LIDB Administration
 - 2.1.7.1. Sprint shall maintain customer information for CLEC customers who subscribe to resold Sprint local service dial tone lines, in Sprint's LIDB in the same manner that it maintains information in LIDB for its own

similarly situated end-user subscribers. Sprint shall update and maintain the CLEC information in LIDB on the same schedule that it uses for its own similarly situated end-user subscribers.

2.1.7.2. Until such time as Sprint's LIDB has the software capability to recognize a resold number as CLEC's, Sprint shall store the resold number in its LIDB at no charge and shall retain revenue for LIDB look-ups to the resold number.

ATTACHMENT III
NETWORK ELEMENTS

1. GENERAL

1.1. Pursuant to the following terms, Sprint will unbundle and separately price and offer Unbundled Network Elements, (“UNEs”) such that CLEC will be able to subscribe to and interconnect to whichever of these unbundled elements CLEC requires for the purpose of providing local telephone service to its end users. CLEC shall pay Sprint each month for the UNEs provisioned, and shall pay the non-recurring charges listed in Attachment I or agreed to by the Parties. It is CLEC’s obligation to combine Sprint-provided UNEs with any facilities and services that CLEC may itself provide.

2. UNBUNDLED NETWORK ELEMENTS

2.1. Sprint shall offer UNEs to CLEC for the purpose of offering Telecommunication Services to CLEC subscribers. Sprint shall offer UNEs to CLEC on an unbundled basis on rates, terms and conditions that are just, reasonable, and non-discriminatory in accordance with the terms and conditions of this Agreement. The initial set of UNEs include:

2.1.1. Network Interface Device (“NID”)

2.1.2. Local Loop

2.1.3. Switching Capability

2.1.3.1. Local Switching

2.1.3.2. Tandem Switching

2.1.4. Interoffice Transport Facilities

2.1.4.1. Common

2.1.4.2. Dedicated

2.1.5. Signaling Networks & Call Related Databases

2.1.6. Operations Support Systems

2.1.7. Operator Services & Directory Assistance

2.2. CLEC may use one or more UNEs to provide any feature, function, capability, or service option that such UNE(s) is (are) technically capable of providing. It is CLEC’s obligation to combine Sprint-provided UNEs with any and all facilities and services whether provided by Sprint, CLEC, or any other party.

2.3. Each UNE provided by Sprint to CLEC shall be at Parity with the quality of design, performance, features, functions, capabilities and other characteristics, including but not limited to levels and types of redundant equipment and facilities for power, diversity and

security, that Sprint provides to itself, Sprint's own subscribers, to a Sprint Affiliate or to any other entity.

3. BONA FIDE REQUEST PROCESS FOR FURTHER UNBUNDLING

- 3.1. Each Party shall promptly consider and analyze access to categories of UNE not covered in this Agreement with the submission of a Network Element Bona Fide Request hereunder. The UNE Bona Fide Request process set forth herein does not apply to those services requested pursuant to FCC Rule § 51.319 adopted in First Report & Order, CC Docket No. 96-98, (rel. Aug. 8, 1996).
- 3.2. A UNE Bona Fide Request shall be submitted in writing and shall include a technical description of each requested UNE.
- 3.3. The requesting Party may cancel a UNE Bona Fide Request at any time, but shall pay the other Party's reasonable and demonstrable costs of processing and/or implementing the UNE Bona Fide Request up to the date of cancellation.
- 3.4. Within ten (10) business days of its receipt, the receiving Party shall acknowledge receipt of the UNE Bona Fide Request.
- 3.5. Except under extraordinary circumstances, within thirty (30) days of its receipt of a UNE Bona Fide Request, the receiving Party shall provide to the requesting Party a preliminary analysis of such UNE Bona Fide Request. The preliminary analysis shall confirm that the receiving Party will offer access to the UNE or will provide a detailed explanation that access to the UNE does not qualify as a UNE that is required to be provided under the Act.
- 3.6. Upon receipt of the preliminary analysis, the requesting Party shall, within thirty (30) days, notify the receiving Party of its intent to proceed or not to proceed.
- 3.7. The receiving Party shall promptly proceed with the UNE Bona Fide Request upon receipt of written authorization from the requesting Party. When it receives such authorization, the receiving Party shall promptly develop the requested services, determine their availability, calculate the applicable prices and establish installation intervals.
- 3.8. As soon as feasible, but not more than ninety (90) days after its receipt of authorization to proceed with developing the UNE Bona Fide Request, the receiving Party shall provide to the requesting Party a UNE Bona Fide Request quote which will include, at a minimum, a description of each UNE, the availability, the applicable rates and the installation intervals.
- 3.9. Within thirty (30) days of its receipt of the UNE Bona Fide Request quote, the requesting Party must either confirm its order for the UNE Bona Fide Request pursuant to the UNE Bona Fide Request quote or seek arbitration by the Commission pursuant to § 252 of the Act.
- 3.10. If a Party to a UNE Bona Fide Request believes that the other Party is not requesting,

negotiating or processing the UNE Bona Fide Request in good faith, or disputes a determination, or price or cost quote, such Party may seek mediation or arbitration by the Commission pursuant to § 252 of the Act.

4. NETWORK INTERFACE DEVICE

- 4.1. The NID is a single-line termination device or that portion of a multiple-line termination device required to terminate a single line or circuit. The function of the NID is to establish the network demarcation point between a CLEC and its subscriber. The NID features two independent chambers or divisions which separate the service provider's network from the subscriber's inside wiring. Each chamber or division contains the appropriate connection points or posts to which the service provider and the subscriber each make their connections. The NID contains a protector which provides a protective ground connection, protection against lightning and other high voltage surges and is capable of terminating cables such as twisted pair cable.
- 4.2. CLEC may connect its NID to Sprint's NID; may connect an unbundled loop to its NID; or may connect its own Loop to Sprint's NID. Sprint will provide one NID termination for each loop. If additional NID terminations are required, CLEC may request them pursuant to process detailed in Article 4 herein.
- 4.3. With respect to multiple-line termination devices, CLEC shall specify the quantity of NIDs it requires within such device.

Figure 1 shows a schematic of a NID.

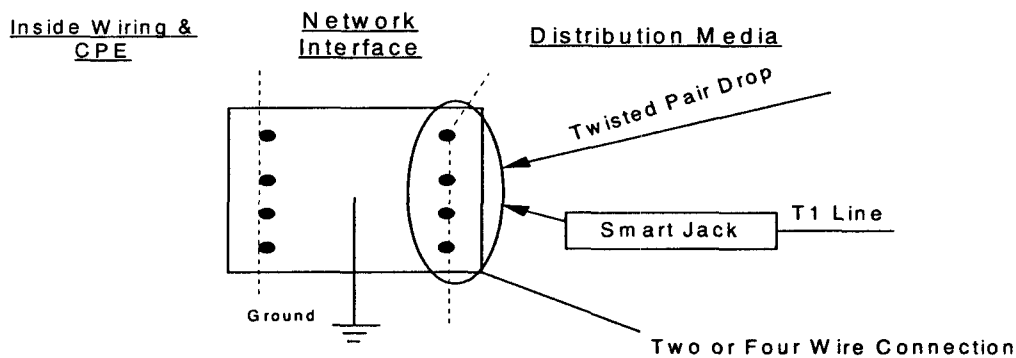

Figure 1 - Network Interface Device

- 4.4. Technical Requirements
 - 4.4.1. The Sprint NID shall provide a clean, accessible point of connection for the inside wiring and for the Distribution Media and/or cross connect to CLEC's NID and shall maintain a connection to ground that meets the requirements set forth below. Each party shall ground its NID independently of the other party's NID.
 - 4.4.2. The NID shall be the interface to subscriber's premises wiring for all loop technologies.

5. LOOP

5.1. A Loop is a transmission path between the main distribution frame [cross-connect], or its equivalent, in a Sprint Central Office or wire center, and up to the demarcation point at a customer's premises. This includes, but is not limited to, two-wire and four-wire copper analog voice-grade loops, two-wire and four-wire loops that are conditioned to transmit the digital signals needed to provide services such as ISDN and DS1-level signals. Sprint will also provide conditioned loops for Telecommunications Services requiring loops unfettered by any intervening equipment (e.g., filters, load coils, range extenders, bridge taps, etc.), so that CLEC can use these loops for a variety of Telecommunications Services that can be supported by use of copper by attaching appropriate terminal equipment at the ends. Where CLEC requests that a loop or a portion of a loop is dedicated to their exclusive use, it will be done at CLEC's expense.

5.2. Loop Capabilities

5.2.1. Voice grade loops are analog loops that facilitate the transmission of analog voice grade signals in the 300-3000 Hz range and terminates in a 2-wire or 4-wire electrical interface at the CLEC's customer's premises. CLEC shall not install equipment on analog loops that exceeds the specified bandwidth.

5.2.2. Sprint will provide non-voice grade loops on the basis of the service that will be provisioned over the loop. Sprint requires CLEC to provide in writing (via the service order) the grade of service desired in a particular loop (e.g., ISDN-BRI, PRI, ADSL, HDSL, DS1, etc.) so that the loop may be engineered to meet the appropriate spectrum compatibility requirements. If CLEC requires a change in the grade of service of a particular loop, (e.g., changing from ISDN service to ADSL), CLEC shall notify Sprint in writing of the requested change in grade of service (via a service order). If Sprint finds that it is not technically feasible to provide the new level of service to CLEC, Sprint will notify CLEC that it is unable to meet the request. If a particular grade of service is installed but CLEC uses the loop to provide a service that exceeds the engineered capacity of a medium (i.e., interferes with other services) or if the service provided by CLEC causes interference to other services Sprint will suspend that particular service then notify CLEC and work with CLEC to develop an agreeable resolution.

5.2.3. CLEC will submit a BFR for non-voice grade loops that are not currently price-listed.

5.2.4. Reverse ADSL Loops. All DSL ATU-C units in Sprint's network, including those integrated into DSLAMs, should either reside within a Sprint host or remote central office. If an ADSL copper loop should start at an outside location, and is looped through a host or remote, and then to the subscriber, the copper plant from the outside location to the Sprint central office must be a facility dedicated to ADSL transmission only and not part of Sprint's regular feeder or distribution plant.

5.2.5. CLEC shall meet the power spectral density requirement given in the respective

technical references listed below:

- 5.2.6. For Basic Rate ISDN: Bellcore TR-NWT-000393 Generic Requirements for ISDN Basic Access Digital Subscriber Lines.
 - 5.2.7. For HDSL installations: Bellcore TA-NWT-001210 Generic Requirements for High-Bit-Rate Digital Subscriber Lines. Some fractional T1 derived products operating at 768 kbps may use the same standard.
 - 5.2.8. For ADSL: ANSI T1.413-1995 (Issue 1) Asymmetrical Digital Subscriber Line (ADSL) Metallic Interface. Note: Issue 2 of the standard will be balloted soon. It will drop an option that was in Issue 1 called Power Boost. Sprint does not permit the Power Boost option used in its local network.
 - 5.2.9. As an alternative to §§ 5.2.6, 5.2.7 and 5.2.8, CLEC may meet the requirements given in ANSI document T1E1.4/97-180R1, "Normative Text for Spectral Compatibility Evaluations" dated June 30, 1997.
- 5.3. If Sprint uses Integrated Digital Loop Carrier or other similar remote concentration devices, Sprint will make alternative arrangements at CLEC's request, to provide an unbundled local loop. Alternative arrangements may include copper facilities, dedicated transmission equipment or the deployment of newer devices providing for multiple hosting. The cost of modifications will be recovered from the requesting CLEC.

6. LOCAL SWITCHING

- 6.1. Local Switching is the Network Element that provides the functionality required to connect the appropriate lines or trunks wired to the Main Distributing Frame (MDF) or Digital Cross Connect (DSX) panel to a desired line or trunk. Such functionality shall include all of the features, functions, and capabilities that the underlying Sprint switch providing such Local Switching function provides for Sprint's own services. Functionality may include, but is not limited to: line signaling and signaling software, digit reception, dialed number translations, call screening, routing, recording, call supervision, dial tone, switching, telephone number provisioning, announcements, calling features and capabilities (including call processing), Centrex, or Centrex like services, Automatic Call Distributor (ACD), CLEC pre-subscription (e.g., long distance Carrier, intraLATA toll), Carrier Identification Code (CIC) portability capabilities, testing and other operational features inherent to the switch and switch software.
- 6.2. Technical Requirements
 - 6.2.1. Sprint shall provide its standard recorded announcements (as designated by CLEC) and call progress tones to alert callers of call progress and disposition. CLEC will use the BFR process for unique announcements.
 - 6.2.2. Sprint shall change a subscriber from Sprint's Telecommunications Services to CLEC's Telecommunications Services without loss of feature functionality unless expressly agreed otherwise by CLEC.

- 6.2.3. Sprint shall control congestion points such as mass calling events, and network routing abnormalities, using capabilities such as Automatic Call Gapping, Automatic Congestion Control, and Network Routing Overflow. Application of such control shall be competitively neutral and not favor any user of unbundled switching or Sprint.
- 6.2.4. Sprint shall offer all Local Switching features that are technically feasible and provide feature offerings at Parity with those provided by Sprint to itself or any other party.
- 6.3. Interface Requirements. Sprint shall provide the following interfaces:
 - 6.3.1. Standard Tip/Ring interface including loopstart or groundstart, on-hook signaling (e.g.: for calling number, calling name and message waiting lamp);
 - 6.3.2. Coin phone signaling;
 - 6.3.3. Basic and Primary Rate Interface ISDN adhering to ANSI standards Q.931, Q.932 and appropriate Bellcore Technical Requirements;
 - 6.3.4. Two-wire analog interface to PBX to include reverse battery, E&M, wink start and DID;
 - 6.3.5. Four-wire analog interface to PBX to include reverse battery, E&M, wink start and DID; and
 - 6.3.6. Four-wire DS1 interface to PBX or subscriber provided equipment (e.g., computers and voice response systems).
- 6.4. Sprint shall provide access to interfaces, including but not limited to:
 - 6.4.1. SS7 Signaling Network, Dial Pulse or Multi-Frequency trunking if requested by CLEC;
 - 6.4.2. Interface to CLEC operator services systems or Operator Services through appropriate trunk interconnections for the system; and
 - 6.4.3. Interface to CLEC directory assistance services through the CLEC switched network or to Directory Services through the appropriate trunk interconnections for the system; and 950 access or other CLEC required access to interexchange carriers as requested through appropriate trunk interfaces.

7. TANDEM SWITCHING

- 7.1. Tandem Switching is the function that establishes a communications path between two switching offices (connecting trunks to trunks) through a third switching office (the tandem switch) including but not limited to CLEC, Sprint, independent telephone companies, IXC's and wireless Carriers. A host/remote end office configuration is not a Tandem Switching arrangement.

7.2. Technical Requirements

7.2.1. The requirements for Tandem Switching include, but are not limited to, the following:

7.2.1.1. Interconnection to Sprint tandem(s) will provide CLEC local interconnection for local and toll access service purposes to the Sprint end offices and NXXs which interconnect with that tandem(s) either directly or through other Sprint facilities for local and toll service purposes, and to other companies which are likewise connected to that tandem(s).

7.2.1.2. Interconnection to a Sprint tandem for transit purposes will provide CLEC interexchange access to Sprint IXCs, other local carriers, ILECs, and CMRS providers which are connected to that tandem.

7.2.1.3. Where a Sprint Tandem Switch also provides End-Office Switch functions, interconnection to a Sprint tandem serving that exchange will also provide CLEC access to Sprint's end offices.

7.2.2. Tandem Switching shall preserve CLASS/LASS features and Caller ID as traffic is processed.

7.2.3. To the extent technically feasible, Tandem Switching shall record billable events for distribution to the billing center designated by CLEC.

7.2.4. Tandem Switching shall control congestion using capabilities such as Automatic Congestion Control and Network Routing Overflow. Congestion control provided or imposed on CLEC traffic shall be at Parity with controls being provided or imposed on Sprint traffic (e.g., Sprint shall not block CLEC traffic and leave its traffic unaffected or less affected).

7.2.5. The Local Switching and Tandem Switching functions may be combined in an office. If this is done, both Local Switching and Tandem Switching shall provide all of the functionality required of each of those Network Elements in this Agreement.

7.2.6. Tandem Switching shall provide interconnection to the E911 PSAP where the underlying Tandem is acting as the E911 Tandem.

7.3. Interface Requirements

7.3.1. Direct trunks will be utilized for interconnection to Sprint Tandems, excluding transit traffic via common trunks as may be required under the Act.

7.3.2. Sprint shall provide all signaling necessary to provide Tandem Switching with no loss of feature functionality.

8. TRANSPORT

8.1. Common Transport

- 8.1.1. Common Transport provides a local interoffice transmission path between the Sprint tandem switch and a Sprint or CLEC end office switch, or between a host in one rate center and a remote in another rate center. Common transport is shared between multiple carriers and is required to be switched at the tandem.
- 8.1.2. Sprint may provide Common Transport at DS-0, DS-1, DS-3, STS-1 or higher transmission bit rate circuits.
- 8.1.3. Sprint shall be responsible for the engineering, provisioning, and maintenance of the underlying Sprint equipment and facilities that are used to provide Common Transport.
- 8.2. Dedicated Transport
 - 8.2.1. Dedicated Transport provides a local interoffice transmission path between Sprint and/or CLEC central offices. Dedicated transport is limited to the use of a single carrier and does not require switching at a tandem.
 - 8.2.2. Technical Requirements
 - 8.2.2.1. Where technologically feasible and available, Sprint shall offer Dedicated Transport consistent with the underlying technology as follows:
 - 8.2.2.2. When Sprint provides Dedicated Transport, the entire designated transmission circuit (e.g.: DS-1, DS-3, STS-1) shall be dedicated to CLEC designated traffic.
 - 8.2.2.3. Where Sprint has technology available, Sprint shall offer Dedicated Transport using currently available technologies including, but not limited to, DS1 and DS3 transport systems, SONET (or SDH) Bi-directional Line Switched Rings, SONET (or SDH) Unidirectional Path Switched Rings, and SONET (or SDH) point-to-point transport systems (including linear add-drop systems), at all available transmission bit rates.

9. SIGNALING SYSTEMS AND DATABASES

9.1. Signaling Systems

9.1.1. Signaling Link Transport

- 9.1.1.1. Signaling Link Transport is a set of two or four dedicated 56 Kbps transmission paths between CLEC-designated Signaling Points of Interconnection (SPOI) that provides appropriate physical diversity and a cross connect at a Sprint STP site.
- 9.1.1.2. Technical Requirements. Signaling Link Transport shall consist of full duplex mode 56 Kbps transmission paths.

9.1.2. Signaling Transfer Points (STPs)

9.1.2.1. Signaling Transfer Points (STPs) provide functionality that enable the exchange of SS7 messages among and between switching elements, database elements and signaling transfer points.

9.1.2.2. Figure 2 depicts Signaling Transfer Points.

Signaling Transfer Points.

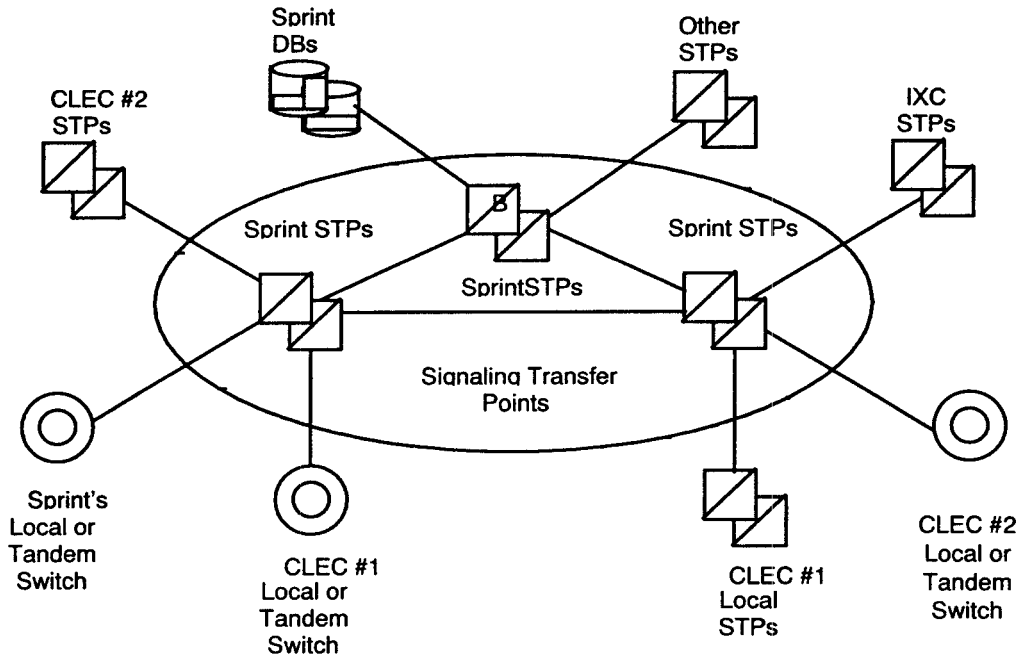

Figure 2

9.1.2.3. Technical Requirements. STPs shall provide access to and fully support the functions of all other Network Elements connected to the Sprint SS7 network. These include:

- 9.1.2.3.1. Sprint Local Switching or Tandem Switching;
- 9.1.2.3.2. Sprint Service Control Points/DataBases;
- 9.1.2.3.3. Third-party local or Tandem Switching systems; and
- 9.1.2.3.4. Third-party-provided STPs.

9.1.2.4. Interface Requirements: Sprint shall provide the following STP

options to connect CLEC or CLEC-designated local switching systems or STPs to the Sprint SS7 network:

- 9.1.2.4.1. An A-link interface from CLEC local switching systems;
and
- 9.1.2.4.2. B or D-link interface from CLEC STPs.
- 9.1.2.4.3. Each type of interface shall be provided by one or more sets (layers) of signaling links, as follows:
- 9.1.2.4.4. An A-link layer shall consist of two links, as depicted in Figure 3.

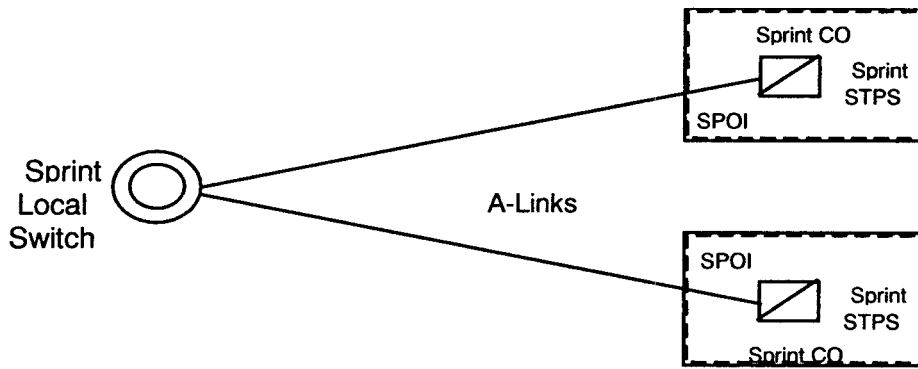

Figure 3. A-Link Interface

- 9.1.2.4.5. A B or D-link layer shall consist of four links, as depicted in Figure 4.

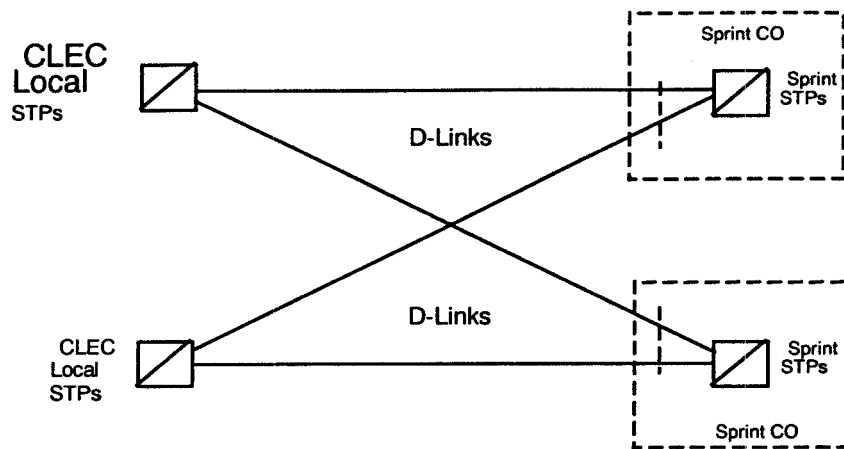

Figure 4. D-Link Interface

9.1.2.4.6. Signaling Point of Interconnection (SPOI) for each link shall be located at a cross-connect element, such as a DSX-1, in the Central Office (CO) where the Sprint STPs is located. There shall be a DS-1 or higher rate transport interface at each of the SPOIs. Each signaling link shall appear as a DS-0 channel within the DS-1 or higher rate interface.

9.2. Line Information Database (LIDB)

9.2.1. The LIDB is a transaction-oriented database accessible CCS networks. It contains records associated with subscribers Line Numbers and Special Billing Numbers. LIDB accepts queries from other Network Elements, or CLEC's network, and provides appropriate responses. The query originator need not be the owner of LIDB data. LIDB queries include functions such as screening billed numbers that provides the ability to accept Collect or Third Number Billing calls and validation of Telephone Line Number based non-proprietary calling cards. The interface for the LIDB functionality is the interface between the Sprint CCS network and other CCS networks. LIDB also interfaces to administrative systems. The administrative system interface provides Work Centers with an interface to LIDB for functions such as provisioning, auditing of data, access to LIDB measurements and reports.

9.2.2. Technical Requirements

9.2.2.1. Prior to the availability of Local Number Portability, Sprint shall enable CLEC to store in Sprint's LIDB any subscriber Line Number or Special Billing Number record, whether ported or not, for which the NPA-NXX or NXX-0/1XX Group is supported by that LIDB, and NPA-NXX and NXX-0/1XX Group Records, belonging to an NPA-NXX or NXX-0/1XX owned by CLEC.

9.2.2.2. Subsequent to the availability of a long-term solution for Number

Portability, Sprint, under the terms of a separate agreement with CLEC, shall enable CLEC to store in Sprint's LIDB any subscriber Line Number or Special Billing Number record, whether ported or not, regardless of the number's NPA-NXX or NXX-0/1XX.

- 9.2.2.3. Sprint shall perform the following LIDB functions for CLEC's subscriber records in LIDB: Billed Number Screening (provides information such as whether the Billed Number may accept Collect or Third Number Billing calls); and Calling Card Validation.
- 9.2.2.4. Sprint shall process CLEC's subscriber records in LIDB at Parity with Sprint subscriber records, with respect to other LIDB functions Sprint shall indicate to CLEC what additional functions (if any) are performed by LIDB in their network.
- 9.2.2.5. Sprint shall perform backup and recovery of all of CLEC's data in LIDB at Parity with backup and recovery of all other records in the LIDB, including sending to LIDB all changes made since the date of the most recent backup copy.

9.3. Toll Free Number Database

9.3.1. The Toll Free Number Database provides functionality necessary for toll free (e.g.: 800 and 888) number services by providing routing information and additional vertical features during call set-up in response to queries from STPs. Sprint, under the terms of a separate agreement with CLEC, shall provide the Toll Free Number Database in accordance with the following:

9.3.2. Technical Requirements

9.3.2.1. Sprint shall make the Sprint Toll Free Number Database available for CLEC to query, from CLEC's designated switch including Sprint unbundled local switching with a toll-free number and originating information.

9.3.2.2. The Toll Free Number Database shall return CLEC identification and, where applicable, the queried toll free number, translated numbers and instructions as it would in response to a query from a Sprint switch.

9.3.3. Interface Requirements. The signaling interface between the CLEC or other local switch and the Toll-Free Number database shall use the TCAP protocol, together with the signaling network interface.

10. OPERATOR SERVICES

10.1. Sprint shall provide for the routing of local Operator Services calls (including but not limited to 0+, 0-) dialed by CLEC subscribers directly to either the CLEC Operator Service platform to the extent Sprint's switch can perform this customized routing, or Sprint Operator Service to the extent there is a Sprint provided Operator Service platform

for that serving area.

10.1.1. Sprint shall provide Operator Services to CLEC as described below until, at CLEC's discretion, Sprint routes calls to the CLEC Local Operator Services platform.

10.1.1.1. Sprint agrees to provide CLEC subscribers the same Operator Services available to Sprint subscribers to the extent there is a Sprint provided Operator Services platform for the serving area. Sprint shall make available its service enhancements on a non-discriminatory basis.

10.1.1.2. Operator Services provided to CLEC subscribers shall be branded in accordance with Part B, Article 10 of this Agreement.

10.1.1.3. Sprint shall exercise the same level of fraud control in providing Operator Service to CLEC that Sprint provides for its own Operator Service.

11. DIRECTORY ASSISTANCE SERVICE

11.1. Sprint shall provide for the routing of directory assistance calls (including but not limited to 411, 555-1212, NPA-555-1212) dialed by CLEC subscribers directly to, at CLEC's option, either (a) the CLEC DA service platform to the extent Sprint's switch can perform this customized routing, or (b) Sprint's DA service platform to the extent there is a Sprint provided DA service platform for that serving area.

11.1.1. Sprint shall provide CLEC with the same level of support for the provisioning of Directory Assistance as Sprint provides itself. Quality of service standards shall be measured at the aggregate level in accordance with standards and performance measurements that are at Parity with the standards and/or performance measurements that Sprint uses and/or which are required by law or regulatory agency rules or orders.

11.1.2. Directory Assistance services provided by Sprint to CLEC subscribers shall be branded in accordance with Part B, Article 10 of this Agreement.

ATTACHMENT IV
INTERCONNECTION

1. LOCAL INTERCONNECTION TRUNK ARRANGEMENT

1.1. The Parties agree to initially use two-way trunks (one-way directionalized) for an interim period. The Parties shall transition from directionalized two-way trunks upon mutual agreement, absent engineering or billing issues. The Parties shall transition all one-way trunks established under this Agreement.

1.1.1. The Parties shall initially reciprocally terminate Local Traffic and IntraLATA/InterLATA toll calls originating on the other Party's network as follows:

1.1.1.1. The Parties shall make available to each other two-way trunks for the reciprocal exchange of combined Local Traffic, and non-equal access IntraLATA toll traffic.

1.1.1.2. Separate two-way trunks will be made available for the exchange of equal-access InterLATA or IntraLATA interexchange traffic that transits Sprint's network.

1.1.1.3. Separate trunks will be utilized for connecting CLEC's switch to each 911/E911 tandem.

1.1.1.4. Separate trunk groups will be utilized for connecting CLEC's Operator Service Center to Sprint's Operator Service center for operator-assisted busy line interrupt/verify.

1.1.1.5. Separate trunk groups will be utilized for connecting CLEC's switch to Sprint's Directory Assistance center in instances where CLEC is purchasing Sprint's unbundled Directory Assistance service.

1.2. Point of Interconnection

1.2.1. Point of Interconnection (POI) means the physical point that establishes the technical interface, the test point, and the operational responsibility hand-off between CLEC and Sprint for the local interconnection of their networks. CLEC is limited to constructing one POI in each Sprint LATA.

1.2.2. CLEC will be responsible for engineering and maintaining its network on its side of the POI. Sprint will be responsible for engineering and maintaining its network on its side of the POI.

1.2.3. For construction of new facilities when the parties choose to interconnect at a mid-span meet, CLEC and Sprint will jointly provision the facilities that connect the two networks. Sprint will be the "controlling carrier" for purposes of MECOD guidelines, as described in the joint implementation plan. Sprint will provide fifty percent (50%) of the facilities or to its exchange boundary,

whichever is less.

1.2.4. Should CLEC prefer, new interconnection facilities may be provisioned via third party facilities or CLEC lease of tariffed services from Sprint. Special construction charges, if applicable, will be charged in accordance with Sprint's access service tariff.

1.2.4.1. If third party leased facilities are used for interconnection, or if leased facilities are provided under a meet-point arrangement between Sprint and a third-party, the POI will be defined as the Sprint office in which the leased circuit terminates. CLEC is responsible to terminate the leased facility in a collocation space (if unbundled loops or switched ports will be purchased in the central office) or a set of Sprint-provided DSX jacks to clearly establish the POI.

1.2.4.2. If Sprint-provided-leased facilities are used, the POI will be defined as the demarcation point between Sprint's facility and CLEC's equipment as long as the end point is within Sprint's exchange area.

2. INTERCONNECTION COMPENSATION MECHANISMS

2.1. Each party is responsible for bringing their facilities to POI.

2.2. Interconnection Compensation

2.2.1. If Sprint provides one-hundred percent (100%) of the facility, Sprint will charge CLEC one-hundred percent (100%) of the lease rates for the facility. CLEC may charge Sprint a proportionate amount of Sprint's dedicated transport rate based on the use of the facility as described above.

2.2.2. If a meet-point is established via construction of new facilities or re-arrangement of existing physical facilities between Sprint and CLEC, the relative use factor will be reduced by the proportionate length of haul provided by each party. Sprint shall be responsible for network provisioning as described in § 1.2.3 herein.

2.2.3. If CLEC provides one-hundred percent (100%) of the interconnection facility via lease of meet-point circuits between Sprint and a third-party; lease of third party facilities; or construction of its own facilities; CLEC may charge Sprint for proportionate amount based on relative usage using the lesser of:

2.2.3.1. Sprint's dedicated interconnection rate;

2.2.3.2. Its own costs if filed and approved by a commission of appropriate jurisdiction; and

2.2.3.3. The actual lease cost of the interconnecting facility.

2.3. Compensation for Local Traffic Transport and Termination

2.3.1. The POI determines the point at which the originating carrier shall pay the

terminating carrier for the completion of that traffic. The following compensation elements shall apply:

2.3.1.1. "Transport," which includes dedicated and common transport and any necessary Tandem Switching of Local Traffic from the interconnection point between the two carriers to the terminating carrier's end-office switch that directly serves the called end-user; and

2.3.1.2. "Termination," which includes the switching of Local Traffic at the terminating carrier's end office switch.

2.4. When a CLEC subscriber places a call to Sprint's subscriber, CLEC will hand off that call to Sprint at the POI. Conversely, when Sprint hands off Local Traffic to CLEC for CLEC to transport and terminate, Sprint may use the established POI or Sprint may designate its own POI.

2.4.1. CLEC and Sprint may each designate a POI at any technically feasible point including but not limited to any electronic or manual cross-connect points, collocations, entrance facilities, and mid-span meets. The transport and termination charges for Local Traffic flowing through a POI shall be as follows:

2.4.1.1. When calls from CLEC are terminating on Sprint's network through the Sprint Tandem Switch, CLEC will pay Sprint for transport charges from the POI to the Tandem for dedicated transport. CLEC shall also pay a charge for Tandem Switching, common transport to the end office, and end-office termination.

2.4.1.2. When Sprint terminates calls to CLEC's subscribers using CLEC's switch, Sprint shall pay CLEC for transport charges from the POI to the CLEC switching center for dedicated transport. Sprint shall also pay to CLEC a charge symmetrical to its own charges for the functionality actually provided by CLEC for call termination.

2.4.1.3. CLEC may choose to establish direct trunking to any given end office. If CLEC leases trunks from Sprint, it shall pay charges for dedicated transport. For calls terminating from CLEC to subscribers served by these directly-trunked end offices, CLEC shall also pay an end-office termination. For Sprint traffic terminating to CLEC over the direct end office trunking, compensation payable by Sprint shall be the same as that detailed in § 2.4.1.2 above.

3. SIGNALING

3.1. Signaling protocol. The parties will interconnect their networks using SS7 signaling where technically feasible and available as defined in FR 905 Bellcore Standards including ISDN user part (ISUP) for trunk signaling and TCAP for CCS-based features in the interconnection of their networks. All Network Operations Forum (NOF) adopted standards shall be adhered to.

- 3.2. Refer to Attachment III, Article 9 for detailed terms of SS7 Network Interconnection.
- 3.3. Standard interconnection facilities shall be extended superframe (ESF) with B8ZS line code. Where ESF/B8ZS is not available, CLEC will agree to using other interconnection protocols on an interim basis until the standard ESF/B8ZS is available. Sprint will provide anticipated dates of availability for those areas not currently ESF/B8ZS compatible.
 - 3.3.1. Where CLEC is unwilling to utilize an alternate interconnection protocol, CLEC will provide Sprint an initial forecast of 64 Kbps clear channel capability ("64K CCC") trunk quantities within thirty (30) days of the Effective Date consistent with the forecasting agreements between the parties. Upon receipt of this forecast, the parties will begin joint planning for the engineering, procurement, and installation of the segregated 64K CCC Local Interconnection Trunk Groups, and the associated ESF facilities, for the sole purpose of transmitting 64K CCC data calls between CLEC and Sprint. Where additional equipment is required, such equipment would be obtained, engineered, and installed on the same basis and with the same intervals as any similar growth job for IXC, CLEC, or Sprint internal customer demand for 64K CCC trunks.

4. NETWORK SERVICING

4.1. Trunk Forecasting

- 4.1.1. The Parties shall work towards the development of joint forecasting responsibilities for traffic utilization over trunk groups. Orders for trunks that exceed forecasted quantities for forecasted locations will be accommodated as facilities and or equipment are available. The Parties shall make all reasonable efforts and cooperate in good faith to develop alternative solutions to accommodate orders when facilities are not available. Intercompany forecast information must be provided by the Parties to each other twice a year. The initial trunk forecast meeting should take place soon after the first implementation meeting. A forecast should be provided at or prior to the first implementation meeting. The semi-annual forecasts shall project trunk gain/loss on a monthly basis for the forecast period, and shall include:
 - 4.1.1.1. Semi-annual forecasted trunk quantities (which include baseline data that reflect actual Tandem and end office Local Interconnection and meet point trunks and Tandem-subtending Local Interconnection end office equivalent trunk requirements) for no more than two years (current plus one year);
 - 4.1.1.2. The use of Common Language Location Identifier (CLLI-MSG), which are described in Bellcore documents BR 795-100-100 and BR 795-400-100;
 - 4.1.1.3. Description of major network projects that affect the other Party will be provided in the semi-annual forecasts. Major network projects include

but are not limited to trunking or network rearrangements, shifts in anticipated traffic patterns, or other activities by either party that are reflected by a significant increase or decrease in trunking demand for the following forecasting period.

- 4.1.2. Parties shall meet to review and reconcile their forecasts if forecasts vary significantly.
- 4.1.3. Each Party shall provide a specified point of contact for planning forecasting and trunk servicing purposes.
- 4.1.4. Trunking can be established to Tandems or end offices or a combination of both via either one-way or two-way trunks. Trunking will be at the DS-0, DS-1, DS-3/OC-3 level, or higher, as agreed upon by CLEC and Sprint.
- 4.1.5. The parties agree to abide by the following if a forecast cannot be agreed to: local interconnection trunk groups will be provisioned to the higher forecast. A blocking standard of one percent (1%) during the average busy hour shall be maintained. Should the Parties not agree upon the forecast, and the Parties engineer facilities at the higher forecast, the Parties agree to abide by the following:
 - 4.1.5.1. In the event that one Party over-forecasts its trunking requirements by twenty percent (20%) or more, and the other Party acts upon this forecast to its detriment, the other Party may recoup any actual and reasonable expense it incurs.
 - 4.1.5.2. The calculation of the twenty percent (20%) over-forecast will be based on the number of DS-1 equivalents for the total traffic volume to Sprint.
 - 4.1.5.3. Expenses will only be recouped for non-recoverable facilities that cannot otherwise be used at any time within twelve (12) months after the initial installation for another purpose including but not limited to: other traffic growth between the Parties, internal use, or use with another party.
- 4.2. Grade of Service. A blocking standard of one percent (1%) during the average busy hour, as defined by each Party's standards, for final trunk groups between a CLEC end office and a Sprint access Tandem carrying meet point traffic shall be maintained. All other final trunk groups are to be engineered with a blocking standard of one percent (1%). Direct end office trunk groups are to be engineered with a blocking standard of one percent (1%).
- 4.3. Trunk Servicing. Orders between the Parties to establish, add, change or disconnect trunks shall be processed by use of an ASR, or another industry standard eventually adopted to replace the ASR for trunk ordering.

5. NETWORK MANAGEMENT

- 5.1. **Protective Protocols.** Either Party may use protective network traffic management controls such as 7-digit and 10-digit code gaps on traffic toward each other's network, when required to protect the public switched network from congestion due to facility failures, switch congestion or failure or focused overload. CLEC and Sprint will immediately notify each other of any protective control action planned or executed.
- 5.2. **Expansive Protocols.** Where the capability exists, originating or terminating traffic reroutes may be implemented by either party to temporarily relieve network congestion due to facility failures or abnormal calling patterns. Reroutes will not be used to circumvent normal trunk servicing. Expansive controls will only be used when mutually agreed to by the parties.
- 5.3. **Mass Calling.** CLEC and Sprint shall cooperate and share pre-planning information, where available, regarding cross-network call-ins expected to generate large or focused temporary increases in call volumes, to prevent or mitigate the impact of these events on the public switched network. Mass calling numbers are not cannot be used in conjunction with INP.

6. USAGE MEASUREMENT

- 6.1. Each Party shall calculate terminating interconnection minutes of use based on standard AMA recordings made within each Party's network, these recordings being necessary for each Party to generate bills to the other Party. In the event either Party cannot measure minutes terminating on its network where technically feasible, the other Party shall provide the measuring mechanism or the Parties shall otherwise agree on an alternate arrangement.
- 6.2. Measurement of minutes of use over Local Interconnection trunk groups shall be in actual conversation seconds. The total conversation seconds over each individual Local Interconnection trunk group will be totaled for the entire monthly bill period and then rounded to the next whole minute.
- 6.3. Prior to the commencement of billing for interconnection, each Party shall provide to the other, the PLU of the traffic terminated to each other over the Local Interconnection trunk groups.
 - 6.3.1. The Parties agree to review the accuracy of the PLU on a regular basis. If the initial PLU is determined to be inaccurate by more than twenty percent (20%), the Parties agree to implement the new PLU retroactively to the Effective Date of the contract.

7. TRANSIT TRAFFIC

- 7.1. Transit Traffic means the delivery of local traffic by CLEC or Sprint originated by the end user of one Party and terminated to a third party LEC, ILEC, or CMRS provider over the local/intraLATA interconnection trunks. The following traffic types will be delivered by either Party: local traffic and intraLATA toll and switched traffic originated from CLEC or Sprint and delivered to such third party LEC, ILEC or CMRS; and intraLATA

800 traffic.

7.2. Terms and Conditions

- 7.2.1. Each Party acknowledges that it is the originating Party's responsibility to enter into arrangements with each third party LEC, ILEC, or CMRS provider for the exchange of transit traffic to that third party, unless the Parties agree otherwise in writing.
- 7.2.2. Each Party acknowledges that the transiting Party does not have any responsibility to pay any third party LEC, ILEC, or CMRS provider charges for termination or any identifiable transit traffic from the originating Party. Both Parties reserve the right not to pay such charges on behalf of the originating Party.

7.3. Payment Terms and Conditions

- 7.3.1. In addition to the payment terms and conditions contained in other sections of this Agreement, the Parties shall compensate each other for transit service as follows:
 - 7.3.1.1. The originating Party shall pay to the transiting Party a transit service charge as set forth in the Pricing Schedule; and
 - 7.3.1.2. If the terminating Party requests, and the transiting Party does not provide, the terminating Party with the originating record in order for the terminating Party to bill the originating Party, the terminating Party shall default bill the transiting Party for transited traffic which does not identify the originating Party.

7.4. Billing Records and Exchange of Data

- 7.4.1. Parties will use the best efforts to convert all networks transporting transit traffic to deliver each call to the other Party's network with SS7 Common Channel Interoffice Signaling (CCIS) and other appropriate TCAP messages in order to facilitate full interoperability and billing functions. The Parties agree to send all message indicators, including originating telephone number, local routing number and CIC.
- 7.4.2. The transiting Party agrees to provide the terminating Party information on traffic originated by a third party CLEC, ILEC, or CMRS provider. To the extent Sprint incurs additional cost in providing this billing information, CLEC agrees to reimburse Sprint for its direct costs of providing this information.
- 7.4.3. To the extent that the industry adopts a standard record format for recording originating and/or terminating transit calls, both Parties agree to comply with the industry-adopted format to exchange records.

8. RESPONSIBILITIES OF THE PARTIES

- 8.1. Sprint and CLEC will review engineering requirements consistent with the Implementation Plan described in Part B, Article 30 and Part C, Attachment IV, Article 4

and otherwise as set forth in this Agreement.

- 8.2. CLEC and Sprint shall share responsibility for all Control Office functions for Local Interconnection Trunks and Trunk Groups, and both parties shall share the overall coordination, installation, and maintenance responsibilities for these trunks and trunk groups.
- 8.3. CLEC and Sprint shall:
 - 8.3.1. Provide trained personnel with adequate and compatible test equipment to work with each other's technicians.
 - 8.3.2. Notify each other when there is any change affecting the service requested, including the due date.
 - 8.3.3. Coordinate and schedule testing activities of their own personnel, and others as applicable, to ensure its interconnection trunks/trunk groups are installed per the interconnection order, meet agreed-upon acceptance test requirements, and are placed in service by the due date.
 - 8.3.4. Perform sectionalization to determine if a trouble is located in its facility or its portion of the interconnection trunks prior to referring the trouble to each other.
 - 8.3.5. Advise each other's Control Office if there is an equipment failure which may affect the interconnection trunks.
 - 8.3.6. Provide each other with a trouble reporting/repair contact number that is readily accessible and available twenty-four (24) hours/seven (7) days a week. Any changes to this contact arrangement must be immediately provided to the other party.
 - 8.3.7. Provide to each other test-line numbers and access to test lines.
 - 8.3.8. Cooperatively plan and implement coordinated repair procedures for the meet point and Local Interconnection trunks and facilities to ensure trouble reports are resolved in a timely and appropriate manner.

ATTACHMENT V
INTERIM NUMBER PORTABILITY

1. SPRINT PROVISION OF INTERIM NUMBER PORTABILITY

- 1.1. Sprint shall provide INP in accordance with requirements of the Act and FCC Rules and Regulations. INP shall be provided with minimum impairment of functionality, quality, reliability and convenience to subscribers of CLEC services until such time as LNP service is offered in the Sprint rate center, in which case INP will be discontinued. Beginning on the date LNP is available in an area, INP orders will no longer be processed, and the Parties will work together to convert the existing INP lines to LNP.

2. INTERIM NUMBER PORTABILITY

- 2.1. Interim Number Portability (INP) shall be provided to the extent technical capabilities allow, by a Sprint directed Remote Call Forwarding (RCF). In the event RCF is a purchased feature of the CLEC end user, there is no relationship between RCF and INP. Once LNP is generally available in Sprint's serving area, RCF will be provided only as a retail service offering by Sprint.
- 2.2. Remote Call Forwarding (RCF) is an INP method to provide subscribers with service-provider portability by redirecting calls within the telephone network. When RCF is used to provide interim number portability, calls to the ported number will first route to the Sprint switch to which the ported number was previously assigned. The Sprint switch will then forward the call to a number associated with the CLEC designated switch to which the number is ported. CLEC may order any additional paths to handle multiple simultaneous calls to the same ported telephone number.
- 2.3. The trunking requirements will be agreed upon by Sprint and CLEC resultant from application of sound engineering principles. These trunking options may include SS7 signaling, in-band signaling, and may be one-way or two-way. The trunks used may be the same as those used for exchange of other Local Traffic and toll traffic between Sprint and CLEC.
- 2.4. Local Exchange Routing Guide (LERG) Reassignment. Portability for an entire NXX shall be provided by utilizing reassignment of the block to CLEC through the LERG. Updates to translations in the Sprint switching office from which the telephone number is ported will be made by Sprint prior to the date on which LERG changes become effective, in order to redirect calls to the CLEC switch via route indexing.
- 2.5. Other Currently Available Number Portability Provisions:
- 2.5.1. Where SS7 is available, Sprint shall exchange with CLEC, SS7 TCAP messages as required for the implementation CLASS or other features available in the Sprint network, if technically feasible.
- 2.5.2. Upon notification that CLEC will be initiating INP, Sprint shall disclose to CLEC

any technical or capacity limitations that would prevent use of the requested INP in the affected switching office. Sprint and CLEC shall cooperate in the process of porting numbers to minimize subscriber out-of-service time, including promptly updating switch translations, where necessary, after notification that physical cut-over has been completed (or initiated), as CLEC may designate.

2.5.3. For INP, CLEC shall have the right to use the existing Sprint 911 infrastructure for all 911 capabilities. When RCF is used for CLEC subscribers, both the ported numbers and shadow numbers shall be stored in ALI databases. CLEC shall have the right to verify the accuracy of the information in the ALI databases.

2.5.3.1. When any INP method is used to port a subscriber, the donor provider must maintain the LIDB record for that number to reflect appropriate conditions as reported to it by the porting service provider. The donor must outclear call records to CLEC for billing and collection from the subscriber. Until such time as Sprint's LIDB has the software capability to recognize a ported number as CLEC's, Sprint shall store the ported number in its LIDB at no charge and shall retain revenue for LIDB look-ups to the ported number. At such time as Sprint's LIDB has the software capability to recognize that the ported number is CLEC's then, if CLEC desires to store numbers on Sprint's LIDB, the parties shall negotiate a separate LIDB database storage and look-up agreement.

2.5.4. Sprint will send a CARE transaction 2231 to notify IXC that access is now provided by a new CLEC for that number.

3. REQUIREMENTS FOR INP

3.1. Cut-Over Process

3.1.1. Sprint and CLEC shall cooperate in the process of porting numbers from one carrier to another so as to limit service outage for the ported subscriber.

3.1.1.1. For a Coordinated Cutover Environment, Sprint and CLEC will coordinate the disconnect and switch translations as close to the requested time as possible. The coordination shall be pre-specified by CLEC and agreed to by both parties and in no case shall begin more than thirty (30) minutes after the agreed upon time.

3.1.1.2. For a Non-Coordinated Cutover Environment, the Parties will agree to a mutually satisfactory cutover time and Sprint shall schedule an update of disconnect and switch translations at the agreed upon cutover time. Such updates will be available to CLEC at Parity with Sprint's own availability for such activity. Sprint and CLEC shall each provide an appropriate operations contact with whom the Parties can contact in the event manual intervention is needed to complete the cutover. In the event of manual intervention, and if Sprint is unable to resolve the issue within sixty (60) minutes, Sprint shall notify CLEC of the issue and CLEC and Sprint shall

determine the plan to resolve it.

- 3.2. Testing. Sprint and CLEC shall cooperate in conducting CLEC's testing to ensure interconnectivity between systems. Sprint shall inform CLEC of any system updates that may affect the CLEC network and Sprint shall, at CLEC's request, perform tests to validate the operation of the network. Additional testing requirements may apply as specified by this Agreement.
- 3.3. Installation Timeframes
 - 3.3.1. Installation Time Frames for RCF INP, where no other work is required, will be completed using Sprint's standard interval for service installation of complex services.
 - 3.3.2. If a subscriber elects to move its Telephone Exchange Service back to Sprint while on an INP arrangement, Sprint shall notify CLEC of the Subscriber's termination of service with CLEC and the Subscriber's instructions regarding its telephone number(s) at Parity with what is offered to other Sprint customers.
- 3.4. Call Referral Announcements. Should CLEC direct Sprint to terminate INP measures, Sprint shall allow CLEC to order a referral announcement available in that switch.
- 3.5. Engineering and Maintenance. Sprint and CLEC will cooperate to ensure that performance of trunking and signaling capacity is engineered and managed at levels which are at Parity with that provided by Sprint to its subscribers and to ensure effective maintenance testing through activities such as routine testing practices, network trouble isolation processes and review of operational elements for translations, routing and network fault isolation.
- 3.6. Operator Services and Directory Assistance
 - 3.6.1. With respect to operator services and directory assistance associated with INP for CLEC subscribers, Sprint shall provide the following:
 - 3.6.1.1. While INP is deployed:
 - 3.6.1.1.1. Sprint shall allow CLEC to order provisioning of Telephone Line Number (TLN) calling cards and Billed Number Screening (BNS), in its LIDB, for ported numbers, as specified by CLEC. Sprint shall continue to allow CLEC access to its LIDB. Other LIDB provisions are specified in this Agreement.
 - 3.6.1.1.2. Where Sprint has control of directory listings for NXX codes containing ported numbers, Sprint shall maintain entries for ported numbers as specified by CLEC.
 - 3.6.2. Sprint OSS shall meet all requirements specified in "Generic Operator Services Switching Requirements for Number Portability," Issue 1.00, Final Draft, April 12, 1996. Editor - Nortel.

- 3.7. **Number Reservation.** When a subscriber ports to another service provider and has previously secured, via a tariffed offering, a reservation of line numbers from the donor provider for possible activation at some future point, these reserved but inactive numbers shall “port” along with the active numbers being ported by the subscriber in order to ensure that the end user subscriber will be permitted to expand its service using the same number range it could use if it remained with the donor provider. However, Sprint will not port vacant numbers.

ATTACHMENT VI
LOCAL NUMBER PORTABILITY

1. INTRODUCTION

- 1.1. Upon implementation of LNP, both Parties agree to conform and provide such LNP pursuant to FCC regulations and compliance with the Industry Forum. To the extent consistent with the FCC and Industry rules as amended from time to time, the requirements for LNP shall include the following:
- 1.1.1. Subscribers must be able to change local service providers and retain the same telephone number(s) within the serving wire center utilizing the portability method in effect within the porting MSA, as offered by the porting carrier, and within the area of portability as defined by the FCC or state commission having jurisdiction over this Agreement.
 - 1.1.2. The LNP network architecture shall not subject Parties to any degradation of service in any relevant measure, including transmission quality, switching and transport costs, increased call set-up time and post-dial delay.
 - 1.1.3. Parties agree that when an NXX is defined as portable, it shall also be defined as portable in all LNP capable offices which have direct trunks to the given switch.
 - 1.1.4. When a subscriber ports to another service provider and has previously secured a reservation of line numbers from the donor provider for possible activation at some future point, these reserved but inactive numbers shall port along with the active numbers being ported by the subscriber only in states where appropriate charges from Sprint tariffs are executed for reserved numbers.
 - 1.1.5. NXX Availability. Not all NXXs in each CO may be available for porting.
 - 1.1.6. LERG Reassignment. Portability for an entire NXX shall be provided by utilizing reassignment of the NXX to CLEC through the LERG.
 - 1.1.7. Coordination of service order work outside normal business hours (8:00AM to 5:00PM) shall be at requesting Party's expense. Premium rates will apply for service order work performed outside normal business hours, weekends, and holidays.
 - 1.1.8. Mass Calling Events. Parties will notify each other at least seven (7) days in advance where ported numbers are utilized. Parties will only port mass calling numbers using switch translations and a choke network for call routing. Porting on mass calling numbers will be handled outside the normal porting process and comply with any applicable state or federal regulatory requirements developed for mass calling numbers.

2. TRANSITION FROM INP TO LNP

- 2.1. Existing INP Arrangements. As Sprint provisions LNP according to the industry schedule in a Wire Center/Central Office, there will be a maximum of a ninety (90) day transition from INP to LNP. At that time, the CLEC will be required to fully implement LNP according to industry standards.
- 2.2. Once LNP is available in an area, all new portability will be LNP and INP will no longer be offered.

3. TESTING

- 3.1. An Interconnection Agreement (or Memorandum of Understanding, or Porting Agreement) detailing conditions for LNP must be in effect between the Parties prior to testing.
- 3.2. Testing and operational issues will be addressed in the implementation plans as described in Part A, Section 30 of the agreement.
- 3.3. CLEC must be NPAC certified and have met Sprint testing parameters prior to activating LNP. If LNP implementation by a CLEC/CMRS provider occurs past the FCC activation date, testing and porting will be done at CLEC's expense.
- 3.4. Parties will cooperate to ensure effective maintenance testing through activities such as routine testing practices, network trouble isolation processes and review of operational elements for translations, routing and network fault isolation.
- 3.5. Parties shall cooperate in testing performed to ensure interconnectivity between systems. All LNP providers shall notify each connected provider of any system updates that may affect the CLEC or Sprint network. Each LNP provider shall, at each other's request, jointly perform tests to validate the operation of the network. Additional testing requirements may apply as specified by this Agreement or in the Implementation Plan.

4. ENGINEERING AND MAINTENANCE

- 4.1. Each LNP provider will monitor and perform effective maintenance through testing and the performance of proactive maintenance activities such as routine testing, development of and adherence to appropriate network trouble isolation processes and periodic review of operational elements for translations, routing and network faults.
- 4.2. It will be the responsibility of the Parties to ensure that the network is stable and maintenance and performance levels are maintained in accordance with state commission requirements. It will be the responsibility of the Parties to perform fault isolation in their network before involving other providers.
- 4.3. Additional engineering and maintenance requirements shall apply as specified in this Agreement or the Implementation Plan.

5. E911/911

- 5.1. When a subscriber ports to another service provider, the donor provider shall use

information provided by the porting provider to update the 911 tandem switch routing tables and 911/ALI database to correctly route, and provide accurate information to PSAP call centers.

- 5.2. Prior to implementation of LNP, the Parties agree to develop, implement, and maintain efficient methods to maintain 911 database integrity when a subscriber ports to another service provider. The Parties agree that the customer shall not be dropped from the 911 database during the transition.

6. BILLING

- 6.1. When an IXC terminates an InterLATA or IntraLATA toll call to either party's local exchange customer whose telephone number has been ported from one party to the other, the parties agree that the party to whom the number has been ported shall receive revenues from those IXC access charges associated with end office switching, local transport, RIC, and CCL, as appropriate, and such other applicable charges. The party from whom the number has been ported shall be entitled only to receive any entrance facility fees, access tandem fees and appropriate local transport charges as set forth in this Agreement. Such access charge payments will be adjusted to the extent that the paying party has already paid Reciprocal Compensation for the same minutes of use. When a call for which access charges are not applicable is terminated to a party's local exchange customer whose telephone number has been ported from the other party, the parties agree that the Reciprocal compensation arrangements described in this Agreement shall apply.
- 6.2. Non-Payment. Customers lose the right to the ported telephone number upon non-payment of charges. Sprint will not port telephone numbers of customers who have bills in default.

ATTACHMENT VII
GENERAL BUSINESS REQUIREMENTS

1. PROCEDURES

1.1. Contact with Subscribers

1.1.1. Each Party at all times shall be the primary contact and account control for all interactions with its subscribers, except as specified by that Party. Subscribers include active subscribers as well as those for whom service orders are pending.

1.1.2. Each Party shall ensure that any of its personnel who may receive subscriber inquiries, or otherwise have opportunity for subscriber contact from the other Party's subscribers regarding the other Party's services: (i) provide appropriate referrals to subscribers who inquire about the other Party's services or products; (ii) do not in any way disparage or discriminate against the other Party, or its products or services; and (iii) do not provide information about its products or services during that same inquiry or subscriber contact.

1.1.3. Sprint shall not use CLEC's request for subscriber information, order submission, or any other aspect of CLEC's processes or services to aid Sprint's marketing or sales efforts.

1.2. Expedite and Escalation Procedures

1.2.1. Sprint and CLEC shall develop mutually acceptable escalation and expedite procedures which may be invoked at any point in the Service Ordering, Provisioning, Maintenance, and Subscriber Usage Data transfer processes to facilitate rapid and timely resolution of disputes. In addition, Sprint and CLEC will establish intercompany contacts lists for purposes of handling subscriber and other matters which require attention/resolution outside of normal business procedures within thirty (30) days after CLEC's request. Each party shall notify the other party of any changes to its escalation contact list as soon as practicable before such changes are effective.

1.2.2. No later than thirty (30) days after CLEC's request Sprint shall provide CLEC with contingency plans for those cases in which normal Service Ordering, Provisioning, Maintenance, Billing, and other procedures for Sprint's unbundled Network Elements, features, functions, and resale services are inoperable.

1.3. **Subscriber of Record.** Sprint shall recognize CLEC as the Subscriber of Record for all Network Elements or services for resale ordered by CLEC and shall send all notices, invoices, and information which pertain to such ordered services directly to CLEC. CLEC will provide Sprint with addresses to which Sprint shall send all such notices, invoices, and information.

1.4. Service Offerings

- 1.4.1. Sprint shall provide CLEC with access to new services, features and functions concurrent with Sprint's notice to CLEC of such changes, if such service, feature or function is installed and available in the network or as soon thereafter as it is installed and available in the network, so that CLEC may conduct market testing.
- 1.4.2. Essential Services. For purposes of service restoral, Sprint shall designate a CLEC access line as an Essential Service Line (ESL) at Parity with Sprint's treatment of its own subscribers and applicable state law or regulation, if any.
- 1.4.3. Blocking Services. Upon request from CLEC, employing Sprint-approved LSR documentation, Sprint shall provide blocking of 700, 900, and 976 services, or other services of similar type as may now exist or be developed in the future, and shall provide Billed Number Screening (BNS), including required LIDB updates, or equivalent service for blocking completion of bill-to-third party and collect calls, on a line, PBX, or individual service basis. Blocking shall be provided the extent (a) it is an available option for the Telecommunications Service resold by CLEC, or (b) it is technically feasible when requested by CLEC as a function of unbundled Network Elements.
- 1.4.4. Training Support. Sprint shall provide training, on a non-discriminatory basis, for all Sprint employees who may communicate, either by telephone or face-to-face, with CLEC subscribers. Such training shall include compliance with the branding requirements of this Agreement including without limitation provisions of forms, and unbranded "Not at Home" notices.

2. ORDERING AND PROVISIONING

- 2.1. Ordering and Provisioning Parity. Sprint shall provide necessary ordering and provisioning business process support as well as those technical and systems interfaces as may be required to enable CLEC to provide the same level and quality of service for all resale services, functions, features, capabilities and unbundled Network Elements at Parity.
- 2.2. National Exchange Access Center (NEAC)
 - 2.2.1. Sprint shall provide a NEAC or equivalent which shall serve as CLEC's point of contact for all activities involved in the ordering and provisioning of Sprint's unbundled Network Elements, features, functions, and resale services.
 - 2.2.2. The NEAC shall provide to CLEC a nationwide telephone number (available from 6:00 a.m. to 8:00 p.m. Eastern Standard Time, Monday through Friday, and 8:00 am through 5:00 P.M. Eastern Standard Time on Saturday) answered by competent, knowledgeable personnel and trained to answer questions and resolve problems in connection with the ordering and provisioning of unbundled Network Elements (except those associated with local trunking interconnection), features, functions, capabilities, and resale services.
 - 2.2.3. Sprint shall provide, as requested by CLEC, through the NEAC, provisioning and

premises visit installation support in the form of coordinated scheduling, status, and dispatch capabilities during Sprint's standard business hours and at other times as agreed upon by the parties to meet subscriber demand.

- 2.3. **Street Address Guide (SAG).** Within thirty (30) days of CLEC's written request, Sprint shall provide to CLEC the SAG data, or its equivalent, in an electronic format mutually agreeable to the parties. All changes and updates to the SAG shall be provided to in a mutually agreed format and timeframe.
- 2.4. **CLASS and Custom Features.** Where generally available in Sprints serving area, CLEC, at the tariff rate, may order the entire set of CLASS, CENTREX and Custom features and functions, or a subset of any one of such features.
- 2.5. **Number Administration/Number Reservation**
 - 2.5.1. Sprint shall provide testing and loading of CLEC's NXX on the same basis as Sprint provides itself or its affiliates. Further, Sprint shall provide CLEC with access to abbreviated dialing codes, , and the ability to obtain telephone numbers, including vanity numbers, while a subscriber is on the phone with CLEC. When CLEC uses numbers from a Sprint NXX, Sprint shall provide the same range of number choices to CLEC, including choice of exchange number, as Sprint provides its own subscribers. Reservation and aging of Sprint NXX's shall remain Sprint's responsibility.
 - 2.5.2. In conjunction with an order for service, Sprint shall accept CLEC orders for vanity numbers and blocks of numbers for use with complex services including, but not limited to, DID, CENTREX, and Hunting arrangements, as requested by CLEC.
 - 2.5.3. For simple services number reservations and aging of Sprint's numbers, Sprint shall provide real-time confirmation of the number reservation when the Electronic Interface has been implemented. For number reservations associated with complex services, Sprint shall provide confirmation of the number reservation within twenty-four (24) hours of CLEC's request. Consistent with the manner in which Sprint provides numbers to its own subscribers, no telephone number assignment is guaranteed until service has been installed.
- 2.6. **Service Order Process Requirements**
 - 2.6.1. **Service Migrations and New Subscriber Additions**
 - 2.6.1.1. For resale services, other than for a CLEC order to convert "as is" a CLEC subscriber, Sprint shall not disconnect any subscriber service or existing features at any time during the migration of that subscriber to CLEC service without prior CLEC agreement.
 - 2.6.1.2. For services provided through UNEs, Sprint shall recognize CLEC as an agent, in accordance with OBF developed processes, for the subscriber in coordinating the disconnection of services provided by another CLEC

or Sprint. In addition, Sprint and CLEC will work cooperatively to minimize service interruptions during the conversion.

2.6.1.3. Unless otherwise directed by CLEC and when technically capable, when CLEC orders resale Telecommunications Services or UNEs all trunk or telephone numbers currently associated with existing services shall be retained without loss of feature capability and without loss of associated ancillary services including, but not limited to, Directory Assistance and 911/E911 capability.

2.6.1.4. For subscriber conversions requiring coordinated cut-over activities, on a per order basis, Sprint, to the extent resources are readily available, and CLEC will agree on a scheduled conversion time, which will be a designated time period within a designated date.

2.6.1.4.1. Any request made by CLEC to coordinate conversions after normal working hours, or on Saturday's or Sunday's or Sprint holidays shall be performed at CLEC's expense.

2.6.1.5. A general Letter of Agency (LOA) initiated by CLEC or Sprint will be required to process a PLC or PIC change order. Providing the LOA, or a copy of the LOA, signed by the end user will not be required to process a PLC or PIC change ordered by CLEC or Sprint. CLEC and Sprint agree that PLC and PIC change orders will be supported with appropriate documentation and verification as required by FCC and Commission rules. In the event of a subscriber complaint of an unauthorized PLC record change where the Party that ordered such change is unable to produce appropriate documentation and verification as required by FCC and Commission rules (or, if there are no rules applicable to PLC record changes, then such rules as are applicable to changes in long distance carriers of record), such Party shall be liable to pay and shall pay all nonrecurring and/or other charges associated with reestablishing the subscriber's local service with the original local carrier.

2.6.2. Intercept Treatment and Transfer Service Announcements. Sprint shall provide unbranded intercept treatment and transfer of service announcements to CLEC's subscribers. Sprint shall provide such treatment and transfer of service announcement in accordance with local tariffs and as provided to similarly situated Sprint subscribers for all service disconnects, suspensions, or transfers.

2.6.3. Due Date

2.6.3.1. Sprint shall supply CLEC with due date intervals to be used by CLEC personnel to determine service installation dates.

2.6.3.2. Sprint shall use best efforts to complete orders by the CLEC requested DDD within agreed upon intervals.

2.6.4. Subscriber Premises Inspections and Installations

2.6.4.1. CLEC shall perform or contract for all CLEC's needs assessments, including equipment and installation requirements required beyond the Demarcation/NID, located at the subscriber premises.

2.6.4.2. Sprint shall provide CLEC with the ability to schedule subscriber premises installations at the same morning and evening commitment level of service offered Sprint's own customers. The parties shall mutually agree on an interim process to provide this functionality during the implementation planning process.

2.6.5. Firm Order Confirmation (FOC)

2.6.5.1. Sprint shall provide to CLEC, a Firm Order Confirmation (FOC) for each CLEC order. The FOC shall contain the appropriate data elements as defined by the OBF standards.

2.6.5.2. For a revised FOC, Sprint shall provide standard detail as defined by the OBF standards.

2.6.5.3. Sprint shall provide to CLEC the date that service is scheduled to be installed.

2.6.6. Order Rejections

2.6.6.1. Sprint shall reject and return to CLEC any order that Sprint cannot provision, due to technical reasons, missing information, or jeopardy conditions resulting from CLEC ordering service at less than the standard order interval. When an order is rejected, Sprint shall, in its reject notification, specifically describe all of the reasons for which the order was rejected. Sprint shall reject any orders on account of the customer Desired Due Date conflicts with published Sprint order provisioning interval requirements.

2.6.7. Service Order Changes

2.6.7.1. In no event will Sprint change a CLEC initiated service order without a new service order directing said change. If an installation or other CLEC ordered work requires a change from the original CLEC service order in any manner, CLEC shall initiate a revised service order. If requested by CLEC, Sprint shall then provide CLEC an estimate of additional labor hours and/or materials.

2.6.7.1.1. When a service order is completed, the cost of the work performed will be reported promptly to CLEC.

2.6.7.2. If a CLEC subscriber requests a service change at the time of installation or other work being performed by Sprint on behalf of CLEC,

Sprint, while at the subscriber premises, shall direct the CLEC subscriber to contact CLEC, and CLEC will initiate a new service order.

- 2.7. Network Testing. Sprint shall perform all its standard pre-service testing prior to the completion of the service order.
- 2.8. Service Suspensions/Restorations. Upon CLEC's request through an Industry Standard, OBF, Suspend/Restore Order, or mutually agreed upon interim procedure, Sprint shall suspend or restore the functionality of any Network Element, feature, function, or resale service to which suspend/restore is applicable. Sprint shall provide restoration priority on a per network element basis in a manner that conforms with any applicable regulatory Rules and Regulations or government requirements.
- 2.9. Order Completion Notification. Upon completion of the requests submitted by CLEC, Sprint shall provide to CLEC a completion notification in an industry standard, OBF, or in a mutually agreed format. The completion notification shall include detail of the work performed, to the extent this is defined within OBF guidelines, and in an interim method until such standards are defined.
- 2.10. Specific Unbundling Requirements. CLEC may order and Sprint shall provision unbundled Network Elements. However, it is CLEC's responsibility to combine the individual network elements should it desire to do so.
- 2.11. Systems Interfaces and Information Exchanges
 - 2.11.1. General Requirements
 - 2.11.1.1. Sprint shall provide to CLEC Electronic Interface(s) for transferring and receiving information and executing transactions for all business functions directly or indirectly related to Service Ordering and Provisioning of Network Elements, features, functions and Telecommunications Services. The Interface(s) shall be developed/designed for the transmission of data from CLEC to Sprint, and from Sprint to CLEC.
 - 2.11.1.2. Interim interfaces or processes may be modified, if so agreed by CLEC and Sprint, during the interim period.
 - 2.11.1.3. Until the Electronic Interface is available, Sprint agrees that the NEAC or similar function will accept CLEC orders. Orders will be transmitted to the NEAC via an interface or method agreed upon by CLEC and Sprint.
 - 2.11.2. For any CLEC subscriber Sprint shall provide, subject to applicable rules, orders, and decisions, CLEC with access CPNI without requiring CLEC to produce a signed LOA, based on CLEC's blanket representation that subscriber has authorized CLEC to obtain such CPNI.
 - 2.11.2.1. The preordering Electronic Interface includes the provisioning of CPNI from Sprint to CLEC. The Parties agree to execute a LOA agreement with

the Sprint end user prior to requesting CPNI for that Sprint end user, and to request end user CPNI only when the end user has specifically given permission to receive CPNI. The Parties agree that they will conform to FCC and/or state regulations regarding the provisioning of CPNI between the parties, and regarding the use of that information by the requesting party.

- 2.11.2.2. The requesting Party will document end user permission obtained to receive CPNI, whether or not the end user has agreed to change local service providers. For end users changing service from one party to the other, specific end user LOAs may be requested by the Party receiving CPNI requests to investigate possible slamming incidents, and for other reasons agreed to by the Parties.
- 2.11.2.3. The receiving Party may also request documentation of an LOA if CPNI is requested and a subsequent service order for the change of local service is not received. On a schedule to be determined by Sprint, Sprint will perform a comparison of requests for CPNI to service orders received for the change of Local Service to CLEC. Sprint will produce a report of unmatched requests for CPNI, and may require an LOA from CLEC for each unmatched request. CLEC agrees to provide evidence of end user permission for receipt of CPNI for all end users in the request by Sprint within three (3) business days of receipt of a request from Sprint. Should Sprint determine that there has been a substantial percentage of unmatched LOA requests, Sprint reserves the right to immediately disconnect the preordering Electronic Interface.
- 2.11.2.4. If CLEC is not able to provide the LOA for ninety-five percent (95%) of the end users requested by Sprint, or if Sprint determines that an LOA is inadequate, CLEC will be considered in breach of the agreement. CLEC can cure the breach by submitting to Sprint evidence of an LOA for each inadequate or omitted LOA within three (3) business days of notification of the breach.
- 2.11.2.5. Should CLEC not be able to cure the breach in the timeframe noted above, Sprint will discontinue processing new service orders until, in Sprint's determination, CLEC has corrected the problem that caused the breach.
- 2.11.2.6. Sprint will resume processing new service orders upon Sprint's timely review and acceptance of evidence provided by CLEC to correct the problem that caused the breach.
- 2.11.2.7. If CLEC and Sprint do not agree that CLEC requested CPNI for a specific end user, or that Sprint has erred in not accepting proof of an LOA, the Parties may immediately request dispute resolution in accordance with Part B. Sprint will not disconnect the preordering

Electronic Interface during the Alternate Dispute Resolution process.

- 2.11.2.8. When available per Electronic Interface Implementation Plan, Sprint shall provide to CLEC Electronic Interface to Sprint information systems to allow CLEC to assign telephone number(s) (if the subscriber does not already have a telephone number or requests a change of telephone number) at Parity.
- 2.11.2.9. When available per Electronic Interface Implementation Plan, Sprint shall provide to CLEC an Electronic Interface to schedule dispatch and installation appointments at Parity.
- 2.11.2.10. When available per Electronic Interface Implementation Plan, Sprint shall provide to CLEC an Electronic Interface to Sprint subscriber information systems which will allow CLEC to determine if a service call is needed to install the line or service at Parity.
- 2.11.2.11. When available per Electronic Interface Implementation Plan, Sprint shall provide to CLEC an Electronic Interface to Sprint information systems which will allow CLEC to provide service availability dates at Parity.
- 2.11.2.12. When available per Electronic Interface Implementation Plan, Sprint shall provide to CLEC an Electronic Interface which transmits status information on service orders at Parity. Until an Electronic Interface is available, Sprint agrees that Sprint will provide proactive status on service orders at the following critical intervals: acknowledgment, firm order confirmation, and completion according to interim procedures to be mutually developed.

2.12. Standards

- 2.12.1. General Requirements. CLEC and Sprint shall agree upon the appropriate ordering and provisioning codes to be used for UNEs. These codes shall apply to all aspects of the unbundling of that element and shall be known as data elements as defined by the Telecommunications Industry Forum Electronic Data Interchange Service Order Subcommittee (TCIF-EDI-SOSC).

3. BILLING

- 3.1. Sprint shall comply with various industry, OBF, and other standards referred to throughout this Agreement. Sprint and CLEC will review any changes to industry standards, and Sprint's interpretation of these standards before they are implemented by Sprint. Until industry standards are adopted and implemented, Sprint shall utilize an interim process as determined by Sprint and reviewed by CLEC as part of the Implementation Plan.
- 3.2. Sprint shall bill CLEC for each service supplied by Sprint to CLEC pursuant to this

Agreement at the rates set forth in this Agreement.

- 3.3. Sprint shall provide to CLEC a single point of contact for interconnection at the National Access Service Center (NASC), and Network Elements and resale at Sprint's NEAC, to handle any Connectivity Billing questions or problems that may arise during the implementation and performance of the terms and conditions of this Agreement.
- 3.4. Sprint shall provide a single point of contact for handling of any data exchange questions or problems that may arise during the implementation and performance of the terms and conditions of this Agreement.
- 3.5. Subject to the terms of this Agreement, CLEC shall pay Sprint within thirty (30) days from the Bill Date. If the payment due date is a Saturday, Sunday or has been designated a bank holiday payment shall be made the next business day.
- 3.6. Billed amounts for which written, itemized disputes or claims have been filed shall be handled in accordance with the procedures set forth in Part B, Article 21 of this Agreement.
- 3.7. Sprint will assess late payment charges to CLEC in accordance with Part B, § 5.5 of this Agreement.
- 3.8. Sprint shall credit CLEC for incorrect Connectivity Billing charges including without limitation: overcharges, services ordered or requested but not delivered, interrupted services, services of poor quality and installation problems if caused by Sprint. Such reimbursements shall be set forth in the appropriate section of the Connectivity Bill pursuant to CABS, or SECAB standards.
- 3.9. Where Parties have established interconnection, Sprint and the CLEC agree to conform to MECAB and MECOD guidelines. They will exchange Billing Account Reference and Bill Account Cross Reference information and will coordinate Initial Billing Company/Subsequent Billing Company billing cycles. Sprint and CLEC will exchange the appropriate records to bill exchange access charges to the IXC. Sprint and CLEC agree to capture EMR records for inward terminating and outward originating calls and send them to the other, as appropriate, in daily or other agreed upon interval, via and agreed upon media (e.g.: Connect Direct, cartridge or magnetic tape).
- 3.10. Revenue Protection. Sprint shall make available to CLEC, at Parity with what Sprint provides to itself, its Affiliates and other local telecommunications CLECs, all present and future fraud prevention or revenue protection features, including prevention, detection, or control functionality embedded within any of the Network Elements. These features include, but are not limited to screening codes, information digits assigned such as information digits '29' and '70' which indicate prison and COCOT pay phone originating line types respectively, call blocking of domestic, international, 800, 888, 900, NPA-976, 700, 500 and specific line numbers, and the capability to require end-user entry of an authorization code for dial tone. Sprint shall, when technically capable and consistent with the implementation schedule for Operations Support Systems (OSS), additionally provide partitioned access to fraud prevention, detection and control

functionality within pertinent OSS.

4. PROVISION OF SUBSCRIBER USAGE DATA

4.1. This Article 4 sets forth the terms and conditions for Sprint's provision of Recorded Usage Data (as defined in this Attachment VIII) to CLEC and for information exchange regarding long distance billing. The parties agree to record call information for interconnection in accordance with this Article 4. To the extent technically feasible, each party shall record all call detail information associated with completed calls originated by or terminated to the other Party's local exchange subscriber. Sprint shall record for CLEC the messages that Sprint records for and bills to its end users. These records shall be provided at a party's request and shall be formatted pursuant to Bellcore's EMR standards and the terms and conditions of this Agreement. These records shall be transmitted to the other party on non-holiday business days in EMR format via CDN, or provided on a cartridge or magnetic tape. Sprint and CLEC agree that they shall retain, at each party's sole expense, copies of all EMR records transmitted to the other party for at least forty-five (45) calendar days after transmission to the other party.

4.2. General Procedures

4.2.1. Sprint shall comply with various industry and OBF standards referred to throughout this Agreement.

4.2.2. Sprint shall comply with OBF standards when recording and transmitting Usage Data.

4.2.3. Sprint shall record all usage originating from CLEC subscribers using resold services ordered by CLEC, where Sprint records those same services for Sprint subscribers. Recorded Usage Data includes, but is not limited to, the following categories of information:

4.2.3.1. Use of CLASS/LASS/Custom Features that Sprint records and bills for its subscribers on a per usage basis.

4.2.3.2. Calls to Information Providers (IP) reached via Sprint facilities will be provided in accordance with § 4.2.7.

4.2.3.3. Calls to Directory Assistance where Sprint provides such service to a CLEC subscriber.

4.2.3.4. Calls completed via Sprint-provided Operator Services where Sprint provides such service to CLEC's local service subscriber and where Sprint records such usage for its subscribers using Industry Standard Bellcore EMR billing records.

4.2.3.5. For Sprint-provided Centrex Service, station level detail.

4.2.4. Retention of Records. Sprint shall maintain a machine readable back-up copy of the message detail provided to CLEC for a minimum of forty-five (45) calendar

days. During the forty-five (45) day period, Sprint shall provide any data back-up to CLEC upon the request of CLEC. If the forty-five (45) day has expired, Sprint may provide the data back-up at CLEC's expense.

- 4.2.5. Sprint shall provide to CLEC Recorded Usage Data for CLEC subscribers. Sprint shall not submit other CLEC local usage data as part of the CLEC Recorded Usage Data.
- 4.2.6. Sprint shall not bill directly to CLEC subscribers any recurring or non-recurring charges for CLEC's services to the subscriber except where explicitly permitted to do so within a written agreement between Sprint and CLEC.
- 4.2.7. Sprint will record 976/N11 calls and transmit them to the IP for billing. Sprint will not bill these calls to either the CLEC or the CLEC's end user.
- 4.2.8. Sprint shall provide Recorded Usage Data to CLEC billing locations as agreed to by the Parties.
- 4.2.9. Sprint shall provide a single point of contact to respond to CLEC call usage, data error, and record transmission inquiries.
- 4.2.10. Sprint shall provide CLEC with a single point of contact and remote identifiers (IDs) for each sending location.
- 4.2.11. CLEC shall provide a single point of contact responsible for receiving usage transmitted by Sprint and receiving usage tapes from a courier service in the event of a facility outage.
- 4.2.12. Sprint shall bill and CLEC shall pay the charges for Recorded Usage Data. Billing and payment shall be in accordance with the applicable terms and conditions set forth herein.

4.3. Charges

- 4.3.1. Access services, including revenues associated therewith, provided in connection with the resale of services hereunder shall be the responsibility of Sprint and Sprint shall directly bill and receive payment on its own behalf from an IXC for access related to interexchange calls generated by resold or rebranded customers.
- 4.3.2. Sprint will be responsible for returning EMI/EMR records to IXCs with the proper EMR Return Code along with the Operating Company Number (OCN) of the associated ANI, (i.e., Billing Number).
- 4.3.3. Sprint will deliver a monthly statement for wholesale services in the medium (e.g.: NDM, paper, diskette, cartridge, magnetic tape, or CD-ROM) requested by CLEC as follows:
 - 4.3.3.1. Invoices will be provided in a standard Carrier Access Billing format or other such format as Sprint may determine;

- 4.3.3.2. Where local usage charges apply and message detail is created to support available services, the originating local usage at the call detail level in standard EMR industry format will be exchanged daily or at other mutually agreed upon intervals, and CLEC will pay Sprint for providing such call detail;
- 4.3.3.3. The Parties will work cooperatively to exchange information to facilitate the billing of in and out collect and inter/intra-region alternately billed messages;
- 4.3.3.4. Sprint agrees to provide information on the end-user's selection of special features where Sprint maintains such information (e.g.: billing method, special language) when CLEC places the order for service;
- 4.3.3.5. Monthly recurring charges for Telecommunications Services sold pursuant to this Agreement shall be billed monthly in advance.
- 4.3.3.6. Sprint shall bill for message provisioning and, if applicable data tape charges, related to the provision of usage records. Sprint shall also bill CLEC for additional copies of the monthly invoice.

4.3.4. For billing purposes, and except as otherwise specifically agreed to in writing, the Telecommunications Services provided hereunder are furnished for a minimum term of one month. Each month is presumed to have thirty (30) days.

4.4. Central Clearinghouse & Settlement

4.4.1. Sprint and CLEC shall agree upon Clearinghouse and Incollect/Outcollect procedures.

4.4.2. Sprint shall settle with CLEC for both intra-region and inter-region billing exchanges of calling card, bill-to-third party, and collect calls under separately negotiated settlement arrangements.

4.5. Lost Data

4.5.1. Loss of Recorded Usage Data. CLEC Recorded Usage Data determined to have been lost, damaged or destroyed as a result of an error or omission by Sprint in its performance of the recording function shall be recovered by Sprint at no charge to CLEC. In the event the data cannot be recovered by Sprint, Sprint shall estimate the messages and associated revenue, with assistance from CLEC, based upon the method described below. This method shall be applied on a consistent basis, subject to modifications agreed to by Sprint and CLEC. This estimate shall be used to adjust amounts CLEC owes Sprint for services Sprint provides in conjunction with the provision of Recorded Usage Data.

4.5.2. Partial Loss. Sprint shall review its daily controls to determine if data has been lost. When there has been a partial loss, actual message and minute volumes shall be reported, if possible through recovery as discussed in 4.1.4.1 above. Where

actual data are not available, a full day shall be estimated for the recording entity, as outlined in the following paragraphs. The amount of the partial loss is then determined by subtracting the data actually recorded for such day from the estimated total for such day.

- 4.5.3. **Complete Loss.** When Sprint is unable to recover data as discussed in 4.1.4.1 above estimated message and minute volumes for each loss consisting of an entire AMA tape or entire data volume due to its loss prior to or during processing, lost after receipt, degaussed before processing, receipt of a blank or unreadable tape, or lost for other causes, shall be reported.
- 4.5.4. **Estimated Volumes.** From message and minute volume reports for the entity experiencing the loss, Sprint shall secure message/minute counts for the four (4) corresponding days of the weeks preceding that in which the loss occurred and compute an average of these volumes. Sprint shall apply the appropriate average revenue per message (“arpm”) agreed to by CLEC and Sprint to the estimated message volume for messages for which usage charges apply to the subscriber to arrive at the estimated lost revenue.
- 4.5.5. If the day of loss is not a holiday but one (1) (or more) of the preceding corresponding days is a holiday, use additional preceding weeks in order to procure volumes for two (2) non-holidays in the previous two (2) weeks that correspond to the day of the week that is the day of the loss
- 4.5.6. If the loss occurs on a weekday that is a holiday (except Christmas and Mother’s day), Sprint shall use volumes from the two (2) preceding Sundays.
- 4.5.7. If the loss occurs on Mother’s day or Christmas day, Sprint shall use volumes from that day in the preceding year multiplied by a growth factor derived from an average of CLEC’s most recent three (3) month message volume growth. If a previous year’s message volumes are not available, a settlement shall be negotiated.

4.6. Testing, Changes and Controls

- 4.6.1. The Recorded Usage Data, EMR format, content, and transmission process shall be tested as agreed upon by CLEC and Sprint.
- 4.6.2. Control procedures for all usage transferred between Sprint and CLEC shall be available for periodic review. This review may be included as part of an Audit of Sprint by CLEC or as part of the normal production interface management function. Breakdowns which impact the flow of usage between Sprint and CLEC must be identified and jointly resolved as they occur. The resolution may include changes to control procedures, so similar problems would be avoided in the future. Any changes to control procedures would need to be mutually agreed upon by CLEC and Sprint.
- 4.6.3. Sprint Software Changes

4.6.3.1. When Sprint plans to introduce any software changes which impact the format or content structure of the usage data feed to CLEC, designated Sprint personnel shall notify CLEC no less than ninety (90) calendar days before such changes are implemented.

4.6.3.2. Sprint shall communicate the projected changes to CLEC's single point of contact so that potential impacts on CLEC processing can be determined.

4.6.3.3. CLEC personnel shall review the impact of the change on the entire control structure. CLEC shall negotiate any perceived problems with Sprint and shall arrange to have the data tested utilizing the modified software if required.

4.6.3.4. If it is necessary for Sprint to request changes in the schedule, content or format of usage data transmitted to CLEC, Sprint shall notify CLEC.

4.6.4. CLEC Requested Changes:

4.6.4.1. CLEC may submit a purchase order to negotiate and pay for changes in the content and format of the usage data transmitted by Sprint.

4.6.4.2. When the negotiated changes are to be implemented, CLEC and/or Sprint shall arrange for testing of the modified data.

4.7. Information Exchange and Interfaces

4.7.1. Product/Service Specific. Sprint shall provide a Bellcore standard 42-50-01 miscellaneous charge record to support the Special Features Star Services if these features are part of Sprint's offering and are provided for Sprint's subscribers on a per usage basis.

4.7.2. Rejected Recorded Usage Data

4.7.2.1. Upon agreement between CLEC and Sprint, messages that cannot be rated and/or billed by CLEC may be returned to Sprint via CDN or other medium as agreed by the Parties. Returned messages shall be sent directly to Sprint in their original EMR format utilizing standard EMR return codes.

4.7.2.2. Sprint may correct and resubmit to CLEC any messages returned to Sprint. Sprint will not be liable for any records determined by Sprint to be billable to a CLEC end user. CLEC will not return a message that has been corrected and resubmitted by Sprint. Sprint will only assume liability for errors and unguideables caused by Sprint.

5. GENERAL NETWORK REQUIREMENTS

5.1. Sprint shall provide repair, maintenance and testing for all resold Telecommunications Services and such UNEs that Sprint is able to test, in accordance with the terms and

conditions of this Agreement.

- 5.2. During the term of this Agreement, Sprint shall provide necessary maintenance business process support as well as those technical and systems interfaces at Parity. Sprint shall provide CLEC with maintenance support at Parity.
- 5.3. Sprint shall provide on a regional basis, a point of contact for CLEC to report vital telephone maintenance issues and trouble reports twenty four (24) hours and seven (7) days a week.
- 5.4. Sprint shall provide CLEC maintenance dispatch personnel on the same schedule that it provides its own subscribers.
- 5.5. Sprint shall cooperate with CLEC to meet maintenance standards for all Telecommunications Services and unbundled network elements ordered under this Agreement. Such maintenance standards shall include, without limitation, standards for testing, network management, call gapping, and notification of upgrades as they become available.
- 5.6. All Sprint employees or contractors who perform repair service for CLEC subscribers shall follow Sprint standard procedures in all their communications with CLEC subscribers. These procedures and protocols shall ensure that:
 - 5.6.1. Sprint employees or contractors shall perform repair service that is equal in quality to that provided to Sprint subscribers; and
 - 5.6.2. Trouble calls from CLEC shall receive response time priority that is equal to that of Sprint subscribers and shall be handled on a "first come first served" basis regardless of whether the subscriber is a CLEC subscriber or a Sprint subscriber.
- 5.7. Sprint shall provide CLEC with scheduled maintenance for resold lines, including, without limitation, required and recommended maintenance intervals and procedures, for all Telecommunications Services and network elements provided to CLEC under this Agreement equal in quality to that currently provided by Sprint in the maintenance of its own network. CLEC shall perform its own testing for UNEs.
- 5.8. Sprint shall give maximum advanced notice to CLEC of all non-scheduled maintenance or other planned network activities to be performed by Sprint on any network element, including any hardware, equipment, software, or system, providing service functionality of which CLEC has advised Sprint may potentially impact CLEC subscribers.
- 5.9. Notice of Network Event. Each party has the duty to alert the other to any network events that can result or have resulted in service interruption, blocked calls, or negative changes in network performance as follows:
 - 5.9.1. Any cable or electronics outage that affects fifty percent (50%) or more of the in-service lines of a central office or one-thousand (1000) access lines, whichever is less with a duration of two (2) minutes or more.
 - 5.9.2. Toll or EAS isolation of an entire exchange with duration of two (2) minutes or

more.

5.9.3. Any digital cross-connect or fiber optic complete system failure lasting two (2) minutes or more.

5.10. On all misdirected calls from CLEC subscribers requesting repair, Sprint shall provide such CLEC subscriber with the correct CLEC repair telephone number as such number is provided to Sprint by CLEC. Once the Electronic Interface is established between Sprint and CLEC, Sprint agrees that CLEC may report troubles directly to a single Sprint repair/maintenance center for both residential and small business subscribers, unless otherwise agreed to by CLEC.

5.11. Upon establishment of an Electronic Interface, Sprint shall notify CLEC via such electronic interface upon completion of trouble report. The report shall not be considered closed until such notification is made. CLEC will contact its subscriber to determine if repairs were completed and confirm the trouble no longer exists.

5.12. Sprint shall perform all testing for resold Telecommunications Services.

5.13. Sprint shall provide test results to CLEC, if appropriate, for trouble clearance. In all instances, Sprint shall provide CLEC with the disposition of the trouble.

5.14. If Sprint initiates trouble handling procedures, it will bear all costs associated with that activity. If CLEC requests the trouble dispatch, and either there is no trouble found, or the trouble is determined to be beyond the end user demarcation point, then CLEC will bear the cost.

6. MISCELLANEOUS SERVICES AND FUNCTIONS

6.1. General

6.1.1. To the extent that Sprint does not provide the services described in this Article 12 to itself, Sprint will use reasonable efforts to facilitate the acquisition of such services for or by CLEC through the existing service provider. CLEC must contract directly with the service provider for such services.

6.1.2. Basic 911 and E911 General Requirements

6.1.2.1. Basic 911 and E911 provides a caller access to the appropriate emergency service bureau by dialing a 3-digit universal telephone number (911). Basic 911 and E911 access from Local Switching shall be provided to CLEC in accordance with the following:

6.1.2.2. E911 shall provide additional routing flexibility for 911 calls. E911 shall use subscriber data, contained in the ALI/DMS, to determine to which PSAP to route the call.

6.1.2.3. Basic 911 and E911 functions provided to CLEC shall be at Parity with the support and services that Sprint provides to its subscribers for

such similar functionality.

6.1.2.4. Basic 911 and E911 access when CLEC purchases Local Switching shall be provided to CLEC in accordance with the following:

6.1.2.4.1. Sprint shall conform to all state regulations concerning emergency services.

6.1.2.4.2. For E911, Sprint shall use its service order process to update and maintain subscriber information in the ALI/DMS. Through this process, Sprint shall provide and validate CLEC subscriber information resident or entered into the ALI/DMS.

6.1.2.4.3. Sprint shall provide for overflow 911 traffic to be routed to Sprint Operator Services or, at CLEC's discretion, directly to CLEC operator services.

6.1.3. Basic 911 and E911 access from the CLEC local switch shall be provided to CLEC in accordance with the following:

6.1.3.1. If required by CLEC, Sprint, at CLEC's sole expense, shall interconnect direct trunks from the CLEC network to the E911 PSAP, or the E911 Tandems as designated by CLEC. Such trunks may alternatively be provided by CLEC.

6.1.3.2. In government jurisdictions where Sprint has obligations under existing agreements as the primary provider of the 911 System to the county (Host SPRINT), CLEC shall participate in the provision of the 911 System as follows:

6.1.3.2.1. Each party shall be responsible for those portions of the 911 System for which it has control, including any necessary maintenance to each party's portion of the 911 System.

6.1.3.2.2. Host SPRINT shall be responsible for maintaining the E-911 database. Sprint shall be responsible for maintaining the E-911 routing database.

6.1.4. If a third party is the primary service provider to a government agency, CLEC shall negotiate separately with such third party with regard to the provision of 911 service to the agency. All relations between such third party and CLEC are totally separate from this Agreement and Sprint makes no representations on behalf of the third party.

6.1.5. If CLEC or its Affiliate is the primary service provider to a government agency, CLEC and Sprint shall negotiate the specific provisions necessary for providing 911 service to the agency and shall include such provisions in an amendment to

this Agreement.

- 6.1.6. Interconnection and database access shall be priced as specified in Attachment I.
- 6.1.7. Sprint shall comply with established, competitively neutral intervals for installation of facilities, including any collocation facilities, diversity requirements, etc.
- 6.1.8. In a resale situation, where it may be appropriate for Sprint to update the ALI database, Sprint shall update such database with CLEC data in an interval at Parity with that experienced by Sprint subscribers.
- 6.1.9. Sprint shall transmit to CLEC daily all changes, alterations, modifications, and updates to the emergency public agency telephone numbers linked to all NPA NXX's. This transmission shall be electronic and be a separate feed from the subscriber listing feed.
- 6.1.10. Sprint shall provide to CLEC the necessary UNEs for CLEC to provide E911/911 services to government agencies. If such elements are not available from Sprint, Sprint shall offer E911/911 service for resale by CLEC to government agencies.
- 6.1.11. The following are Basic 911 and E911 Database Requirements
 - 6.1.11.1. The ALI database shall be managed by Sprint, but is the property of Sprint and CLEC for those records provided by CLEC.
 - 6.1.11.2. To the extent allowed by the governmental agency, and where available, copies of the MSAG shall be provided within three business days from the time requested and provided on diskette, magnetic tape, or in a format suitable for use with desktop computers.
 - 6.1.11.3. CLEC shall be solely responsible for providing CLEC database records to Sprint for inclusion in Sprint's ALI database on a timely basis.
 - 6.1.11.4. Sprint and CLEC shall arrange for the automated input and periodic updating of the E911 database information related to CLEC end users. Sprint shall work cooperatively with CLEC to ensure the accuracy of the data transfer by verifying it against the MSAG. Sprint shall accept electronically transmitted files or magnetic tape that conform to NENA Version #2 format.
 - 6.1.11.5. CLEC shall assign an E911 database coordinator charged with the responsibility of forwarding CLEC end user ALI record information to Sprint or via a third-party entity, charged with the responsibility of ALI record transfer. CLEC assumes all responsibility for the accuracy of the data that CLEC provides to Sprint.
 - 6.1.11.6. CLEC shall provide information on new subscribers to Sprint within one (1) business day of the order completion. Sprint shall update the database within two (2) business days of receiving the data from CLEC. If

Sprint detects an error in the CLEC provided data, the data shall be returned to CLEC within two (2) business days from when it was provided to Sprint. CLEC shall respond to requests from Sprint to make corrections to database record errors by uploading corrected records within two (2) business days. Manual entry shall be allowed only in the event that the system is not functioning properly.

6.1.11.7. Sprint agrees to treat all data on CLEC subscribers provided under this Agreement as confidential and to use data on CLEC subscribers only for the purpose of providing E911 services.

6.1.11.8. Sprint shall adopt use of a CLEC Code (NENA standard five-character field) on all ALI records received from CLEC. The CLEC Code will be used to identify the CLEC of record in LNP/INP configurations.

6.1.11.9. Sprint shall identify which ALI databases cover which states, counties or parts thereof, and identify and communicate a Point of Contact for each.

6.1.12. The following are basic 911 and E911 Network Requirements

6.1.12.1. Sprint, at CLEC's option, shall provide a minimum of two (2) E911 trunks per 911 switching entity, or that quantity which will maintain P.01 transmission grade of service, whichever is the higher grade of service. Where applicable these trunks will be dedicated to routing 911 calls from CLEC's switch to a Sprint selective router.

6.1.12.2. Sprint shall provide the selective routing of E911 calls received from CLEC's switching office. This includes the ability to receive the ANI of CLEC's subscriber, selectively route the call to the appropriate PSAP, and forward the subscriber's ANI to the PSAP. Sprint shall provide CLEC with the appropriate CLLI codes and specifications regarding the Tandem serving area associated addresses and meet-points in the network.

6.1.12.3. CLEC shall ensure that its switch provides an eight-digit ANI consisting of an information digit and the seven-digit exchange code. CLEC shall also ensure that its switch provides the line number of the calling station. Where applicable, CLEC shall send a ten-digit ANI to Sprint when there is an ANI failure the CLEC shall send the Central Office Trunk Group number in the Emergency Service Central Office (ESCO) format.

6.1.12.4. Each ALI discrepancy report shall be jointly researched by Sprint and CLEC. Corrective action shall be taken immediately by the responsible party.

6.1.12.5. Where Sprint controls the 911 network, Sprint should provide CLEC with a detailed written description of, but not limited to, the following information:

- 6.1.12.5.1. Geographic boundaries of the government entities, PSAPs, and exchanges as necessary.
- 6.1.12.5.2. LECs rate centers/exchanges, where “Rate Center” is defined as a geographically specified area used for determining mileage dependent rates in the Public Switched Telephone Network.
- 6.1.12.5.3. Technical specifications for network interface, Technical specifications for database loading and maintenance.
- 6.1.12.5.4. Sprint shall identify special routing arrangements to complete overflow.
- 6.1.12.5.5. Sprint shall begin restoration of E911 and/or E911 trunking facilities immediately upon notification of failure or outage. Sprint must provide priority restoration of trunks or networks outages on the same terms/conditions it provides itself and without the imposition of Telecommunications Service Priority (TSP).
- 6.1.12.5.6. Repair service shall begin immediately upon receipt of a report of a malfunction. Repair service includes testing and diagnostic service from a remote location, dispatch of or in-person visit(s) of personnel. Technicians will be dispatched without delay.
- 6.1.12.6. Sprint shall identify any special operator-assisted calling requirements to support 911.
- 6.1.12.7. Trunking shall be arranged to minimize the likelihood of central office isolation due to cable cuts or other equipment failures. There will be an alternate means of transmitting a 911 call to a PSAP in the event of failures.
- 6.1.12.8. Circuits shall have interoffice, loop and CLEC system diversity when such diversity can be achieved using existing facilities. Circuits will be divided as equally as possible across available CLEC systems. Diversity will be maintained or upgraded to utilize the highest level of diversity available in the network.
- 6.1.12.9. All 911 trunks must be capable of transmitting and receiving Baudot code or ASII necessary to support the use of Telecommunications Devices for the Deaf (TTY/TDDs).

6.1.13. Basic 911 and E911 Additional Requirements

- 6.1.13.1. All CLEC lines that have been ported via INP shall reach the correct PSAP when 911 is dialed. Sprint shall send both the ported number and the CLEC number (if both are received from CLEC). The PSAP attendant shall see both numbers where the PSAP is using a standard ALI display screen and the PSAP extracts both numbers from the data that is sent.
- 6.1.13.2. Sprint shall work with the appropriate government agency to provide CLEC the ten-digit POTS number of each PSAP which sub-tends each Sprint selective router/911 Tandem to which CLEC is interconnected.
- 6.1.13.3. Sprint shall notify CLEC 48 hours in advance of any scheduled testing or maintenance affecting CLEC 911 service, and provide notification as soon as possible of any unscheduled outage affecting CLEC 911 service.
- 6.1.13.4. CLEC shall be responsible for reporting all errors, defects and malfunctions to Sprint. Sprint shall provide CLEC with the point of contact for reporting errors, defects, and malfunctions in the service and shall also provide escalation contacts.
- 6.1.13.5. CLEC may enter into subcontracts with third parties, including CLEC Affiliates, for the performance of any of CLEC's duties and obligations stated herein.
- 6.1.13.6. Sprint shall provide sufficient planning information regarding anticipated moves to SS7 signaling, for 911 services, for the next twelve (12) months.
- 6.1.13.7. Sprint shall provide notification of any impacts to the 911 services provided by Sprint to CLEC resulting from of any pending Tandem moves, NPA splits, or scheduled maintenance outages, with enough time to react.
- 6.1.13.8. Sprint shall identify process for handling of "reverse ALI" inquiries by public safety entities.
- 6.1.13.9. Sprint shall establish a process for the management of NPA splits by populating the ALI database with the appropriate new NPA codes.

6.2. Directory Assistance Service

- 6.2.1. Sprint shall provide for the routing of directory assistance calls (including but not limited to 411, 555-1212, NPA-555-1212) dialed by CLEC subscribers directly to, at CLEC's option, either (a) the CLEC DA service platform to the extent Sprint's switch can perform this customized routing, or (b) Sprint DA service platform to the extent there is a DA service platform for that serving area.
- 6.2.2. CLEC subscribers shall be provided the capability by Sprint to dial the same telephone numbers for access to CLEC Directory Assistance that Sprint subscribers dial to access Sprint Directory Assistance.

- 6.2.3. Should CLEC elect to resell Sprint Directory Assistance, Sprint shall provide Directory Assistance functions and services to CLEC for its subscribers as described below.
- 6.2.3.1. Sprint agrees to provide CLEC subscribers with the same Directory Assistance service available to Sprint subscribers.
- 6.2.3.2. Sprint shall notify CLEC in advance of any changes or enhancements to its DA service, and shall make available such service enhancements on a non-discriminatory basis to CLEC.
- 6.2.3.3. Sprint shall provide Directory Assistance to CLEC subscribers in accordance with Sprint's internal local operator procedures and standards.
- 6.2.3.4. Sprint shall provide CLEC with the same level of support for the provisioning of Directory Assistance as Sprint provides itself. Quality of service standards shall be measured at the aggregate level in accordance with standards and performance measurements that are at Parity with the standards and/or performance measurements that Sprint uses and/or which are required by law, regulatory agency, or by Sprint's own internal procedures, whichever are the most rigorous.
- 6.2.3.5. Service levels shall comply, at a minimum, with State Regulatory Commission requirements for number of rings to answer, and disaster recovery options.
- 6.2.3.6. CLEC or its designated representatives may inspect any Sprint owned or sub-contracted office, which provides DA services, upon five (5) business days notice to Sprint.
- 6.2.3.7. Directory Assistance services provided by Sprint to CLEC subscribers shall be branded in accordance with Part B, Article 10 of this Agreement.
- 6.2.3.8. Sprint shall provide the following minimum Directory Assistance capabilities to CLEC's subscribers:
- 6.2.3.8.1. A maximum of two subscriber listings and/or addresses or Sprint Parity per CLEC subscriber request.
- 6.2.3.8.2. Telephone number and address to CLEC subscribers upon request, except for non-published/unlisted numbers, in the same states where such information is provided to Sprint subscribers.
- 6.2.3.8.3. Upon CLEC's request, call completion to the requested number for local and intraLATA toll calls shall be sent to the network specified by CLEC where such call completion routing is technically feasible. If fulfillment of such routing request is not technically feasible, Sprint shall promptly notify CLEC if and

when such routing becomes technically feasible. Rating and billing responsibility shall be agreed to by CLEC and Sprint.

6.2.3.8.4. Populate the Directory Assistance database in the same manner and in the same time frame as for Sprint subscribers.

6.2.3.8.5. Any information provided by a Directory Assistance Automatic Response Unit (ARU) shall be repeated the same number of times for CLEC subscribers as for Sprint's subscribers.

6.2.3.9. Sprint shall provide CLEC call detail records in a mutually agreed format and manner.

6.3. Operator Services

6.3.1. Sprint shall provide for the routing of local operator services calls (including but not limited to 0+, 0-) dialed by CLEC subscribers directly to either the CLEC operator service platform or Sprint operator service platform to the extent Sprint's switch can perform this customized routing, as specified by CLEC.

6.3.2. CLEC subscribers shall be provided the capability by Sprint to dial the same telephone numbers to access CLEC operator service that Sprint subscribers dial to access Sprint operator service.

6.3.3. Should CLEC elect to resell Sprint Operator Services, Sprint shall provide Operator Services to as described below.

6.3.3.1. Sprint agrees to provide CLEC subscribers the same Operator Services available to Sprint subscribers. Sprint shall make available its service enhancements on a non-discriminatory basis.

6.3.3.2. Operator Services provided to CLEC subscribers shall be branded in accordance with Part B, Article 10 of this Agreement.

6.3.3.3. Sprint shall provide the following minimum Operator Service capabilities to CLEC subscribers:

6.3.3.3.1. Sprint shall complete 0+ and 0- dialed local calls.

6.3.3.3.2. Sprint shall complete 0+ intraLATA toll calls.

6.3.3.3.3. Sprint shall complete calls that are billed to a 0+ access calling card.

6.3.3.3.4. Sprint shall complete person-to-person calls.

6.3.3.3.5. Sprint shall complete collect calls.

- 6.3.3.3.6. Sprint shall provide the capability for callers to bill to a third party and complete such calls.
 - 6.3.3.3.7. Sprint shall complete station-to-station calls.
 - 6.3.3.3.8. Sprint shall process emergency calls.
 - 6.3.3.3.9. Sprint shall process Busy Line Verify and Busy Line Verify and Interrupt requests.
 - 6.3.3.3.10. To the extent not prohibited by law or regulation, Sprint shall process emergency call trace.
 - 6.3.3.3.11. Sprint shall process operator-assisted directory assistance calls.
 - 6.3.3.3.12. Sprint shall provide basic rate quotes, subject to Sprint's operator systems being capable to perform unique rating for CLEC.
 - 6.3.3.3.13. Sprint shall process time-and-charges requests, at Parity with Sprint's own service offerings.
 - 6.3.3.3.14. Sprint shall route 0- traffic directly to a "live" operator team.
 - 6.3.3.3.15. When requested by CLEC, Sprint shall provide instant credit on operator services calls as provided to Sprint subscribers or shall inform CLEC subscribers to call an 800 number for CLEC subscriber service to request a credit. Sprint shall provide one 800 number for business subscribers and another for residential subscribers.
 - 6.3.3.3.16. Caller assistance for the disabled shall be provided in the same manner as provided to Sprint subscribers.
 - 6.3.3.3.17. When available, Sprint shall provide operator-assisted conference calling.
- 6.3.4. Operator Service shall provide CLEC's local usage rates when providing rate quote and time-and-charges services, and subject to the provisions described herein.
 - 6.3.5. Operator Service shall adhere to equal access requirements.
 - 6.3.6. Sprint shall exercise the same level of fraud control in providing Operator Service to CLEC that Sprint provides for its own operator service.

- 6.3.7. Sprint shall query for Billed Number Screening restrictions when handling Collect, Third Party, and Calling Card Calls, both for station to station and person to person call types.
 - 6.3.8. Sprint shall provide at an aggregate level for the operator service center, service measurements and accounting reports to CLEC at Parity with the service measurements and accounting reports Sprint provides itself.
 - 6.3.9. CLEC or its designated representatives may inspect any Sprint owned or sub-contracted office, which provides Operator Services, upon five (5) business days notice to Sprint.
 - 6.3.10. Sprint shall direct CLEC subscriber account and other similar inquiries to the subscriber service center designated by CLEC.
 - 6.3.11. Sprint shall provide call records in accordance with Article 4 of this Attachment VIII.
 - 6.3.12. Sprint shall accept and process overflow 911 traffic routed from CLEC to the underlying platform used to provide Operator Service where such overflow is performed by Sprint for its subscribers.
 - 6.3.13. Sprint shall engineer its BLV/BLVI facilities to accommodate the anticipated volume of BLV/BLVI requests during the Busy Hour. CLEC may, from time to time, provide its anticipated volume of BLV/BLVI requests to Sprint. In those instances when the BLV/BLVI systems and databases become unavailable, Sprint shall promptly inform CLEC.
- 6.4. Directory Assistance and Listings Service Requests
- 6.4.1. These requirements pertain to Sprint's DA and Listings Service Request process that enables CLEC to (a) submit CLEC subscriber information for inclusion in Sprint Directory Assistance and Directory Listings databases; (b) submit CLEC subscriber information for inclusion in published directories; and (c) provide CLEC subscriber delivery address information to enable Sprint to fulfill directory distribution obligations.
 - 6.4.2. When implemented by the Parties, Sprint shall accept orders on a real-time basis via electronic interface in accordance with OBF Directory Service Request standards within three (3) months of the effective date of this Agreement. In the interim, Sprint shall create a standard format and order process by which CLEC can place an order with a single point of contact within Sprint.
 - 6.4.3. Sprint will provide to CLEC the following Directory Listing Migration Options, valid under all access methods, including but not limited to, Resale, UNEs and Facilities-Based:
 - 6.4.3.1. Migrate with no Changes. Retain all white page listings for the subscriber in both DA and DL. Transfer ownership and billing for white

page listings to CLEC.

6.4.3.2. **Migrate with Additions.** Retain all white page listings for the subscriber in both DA and DL. Incorporate the specified additional listings order. Transfer ownership and billing for the white page listings to CLEC.

6.4.3.3. **Migrate with Deletions.** Retain all white page listings for the subscriber in both DA and DL. Delete the specified listings from the listing order. Transfer ownership and billing for the white page listings to CLEC.

6.4.3.4. To ensure accurate order processing, Sprint or its directory publisher shall provide to CLEC the following information, with updates promptly upon changes:

6.4.3.4.1. A matrix of NXX to central office;

6.4.3.4.2. Geographical maps if available of Sprint service area;

6.4.3.4.3. A description of calling areas covered by each directory, including but not limited to maps of calling areas and matrices depicting calling privileges within and between calling areas;

6.4.3.4.4. Listing format rules;

6.4.3.4.5. Standard abbreviations acceptable for use in listings and addresses;

6.4.3.4.6. Titles and designations; and

6.4.3.4.7. A list of all available directories and their Business Office close dates

6.4.4. Based on changes submitted by CLEC, Sprint shall update and maintain directory assistance and directory listings data for CLEC subscribers who:

6.4.4.1. Disconnect Service;

6.4.4.2. Change CLEC;

6.4.4.3. Install Service;

6.4.4.4. Change any service which affects DA information;

6.4.4.5. Specify Non-Solicitation; and

6.4.4.6. Are Non-Published, Non-Listed, or Listed.

- 6.4.5. Sprint shall not charge for storage of CLEC subscriber information in the DA and DL systems.
- 6.4.6. CLEC shall not charge for storage of Sprint subscriber information in the DA and DL systems.
- 6.5. **Directory Listings General Requirements.** CLEC acknowledges that many directory functions including but not limited to yellow page listings, enhanced white page listings, information pages, directory proofing, and directory distribution are not performed by Sprint but rather are performed by and are under the control of the directory publisher. CLEC acknowledges that for a CLEC subscriber's name to appear in a directory, CLEC must submit a Directory Service Request (DSR). Sprint shall use reasonable efforts to assist CLEC in obtaining an agreement with the directory publisher that treats CLEC at Parity with the publisher's treatment of Sprint.
- 6.5.1. This § 6.5.1 pertains to listings requirements published in the traditional white pages.
- 6.5.2. Sprint shall include in its master subscriber system database all white pages listing information for CLEC subscribers in Sprint territories where CLEC is providing local telephone exchange services and has submitted a DSR.
- 6.5.3. Sprint agrees to include one basic White pages listing for each CLEC customer located within the geographic scope of its White Page directories, at no additional charge to CLEC. A basic White Pages listing is defined as a customer name, address and either the CLEC assigned number for a customer or the number for which number portability is provided, but not both numbers. Basic White Pages listings of CLEC customers will be interfiled with listings of Sprint and other LEC customers.
- 6.5.4. CLEC agrees to provide CLEC customer listing information, including without limitation directory distribution information, to Sprint, at no charge. Sprint will provide CLEC with the appropriate format for provision of CLEC customer listing information to Sprint. The parties agree to adopt a mutually acceptable electronic format for the provision of such information as soon as practicable. In the event OBF adopts an industry-standard format for the provision of such information, the parties agree to adopt such format.
- 6.5.5. Sprint agrees to provide White Pages database maintenance services to CLEC. CLEC will be charged a Service Order entry fee upon submission of Service Orders into Sprint's Service Order Entry (SOE) System, which will include compensation for such database maintenance services. Service Order entry fees apply when Service Orders containing directory records are entered into Sprint's SOE System initially, and when Service Orders are entered in order to process a requested change to directory records.
- 6.5.6. CLEC customer listing information will be used solely for the provision of directory services, including the sale of directory advertising to CLEC customers.

- 6.5.7. In addition to a basic White Pages listing, Sprint will provide, at the rates set forth in Attachment I of this Agreement, tariffed White Pages listings (e.g.: additional, alternate, foreign and non-published listings) for CLEC to offer for resale to CLEC's customers.
- 6.5.8. Sprint, or its directory publisher, agree to provide White Pages distribution services to CLEC customers within Sprint's service territory at no additional charge to CLEC. Sprint represents that the quality, timeliness, and manner of such distribution services will be at Parity with those provided to Sprint and to other CLEC customers.
- 6.5.9. Sprint agrees to include critical contact information pertaining to CLEC in the "Information Pages" of those of its White Pages directories containing information pages, provided that CLEC meets criteria established by its directory publisher. Critical contact information includes CLEC's business office number, repair number, billing information number, and any other information required to comply with applicable regulations, but not advertising or purely promotional material. CLEC will not be charged for inclusion of its critical contact information. The format, content and appearance of CLEC's critical contact information will conform to applicable Sprint directory publisher's guidelines and will be consistent with the format, content and appearance of critical contact information pertaining to all CLECs in a directory.
- 6.5.10. Sprint will accord CLEC customer listing information the same level of confidentiality that Sprint accords its own proprietary customer listing information. Sprint shall ensure that access to CLEC customer proprietary listing information will be limited solely to those of Sprint and Sprint's directory publisher's employees, agents and contractors that are directly involved in the preparation of listings, the production and distribution of directories, and the sale of directory advertising. Sprint will advise its own employees, agents and contractors and its directory publisher of the existence of this confidentiality obligation and will take appropriate measures to ensure their compliance with this obligation. Notwithstanding any provision herein to the contrary, the furnishing of White Pages proofs to a CLEC that contains customer listings of both Sprint and CLEC will not be deemed a violation of this confidentiality provision.
- 6.5.11. Sprint will sell or license CLEC's customer listing information to any third parties unless CLEC submits written requests that Sprint refrain from doing so. Sprint and CLEC will work cooperatively to share any payments for the sale or license of CLEC customer listing information to third parties. Any payments due to CLEC for its customer listing information will be net of administrative expenses incurred by Sprint in providing such information to third parties. The parties acknowledge that the release of CLEC's customer listing to Sprint's directory publisher will not constitute the sale or license of CLEC's customer listing information causing any payment obligation to arise pursuant to this § 6.5.11.
- 6.6. Other Directory Services. Sprint will exercise reasonable efforts to cause its directory

publisher to enter into a separate agreement with CLEC which will address other directory services desired by CLEC as described in this § 6.6. Both parties acknowledge that Sprint's directory publisher is not a party to this Agreement and that the provisions contained in this § 6.6 are not binding upon Sprint's directory publisher.

- 6.6.1. Sprint's directory publisher will negotiate with CLEC concerning the provision of a basic Yellow Pages listing to CLEC customers located within the geographic scope of publisher's Yellow Pages directories and distribution of Yellow Pages directories to CLEC customers.
- 6.6.2. Directory advertising will be offered to CLEC customers on a nondiscriminatory basis and subject to the same terms and conditions that such advertising is offered to Sprint and other CLEC customers. Directory advertising will be billed to CLEC customers by directory publisher.
- 6.6.3. Directory publisher will use commercially reasonable efforts to ensure that directory advertising purchased by customers who switch their service to CLEC is maintained without interruption.
- 6.6.4. Information pages, in addition to any information page or portion of an information page containing critical contact information as described above in § 6.5.9 may be purchased from Sprint's directory publisher, subject to applicable directory publisher guidelines, criteria, and regulatory requirements.
- 6.6.5. Directory publisher maintains full authority as publisher over its publishing policies, standards and practices, including decisions regarding directory coverage area, directory issue period, compilation, headings, covers, design, content or format of directories, and directory advertising sales.
- 6.7. Directory Assistance Data. This section refers to the residential, business, and government subscriber records used by Sprint to create and maintain databases for the provision of live or automated operator assisted Directory Assistance. Directory Assistance Data is information that enables telephone exchange CLECs to swiftly and accurately respond to requests for directory information, including, but not limited to name, address and phone numbers. Under the provisions of the Act and the FCC's Interconnection order, Sprint shall provide unbundled and non-discriminatory access to the residential, business and government subscriber records used by Sprint to create and maintain databases for the provision of live or automated operator assisted Directory Assistance. This access shall be provided under separate contract.
- 6.8. Systems Interfaces and Exchanges
 - 6.8.1. Directory Assistance Data Information Exchanges and Interfaces
 - 6.8.1.1. Subscriber List Information
 - 6.8.1.1.1. Sprint shall provide to CLEC, within sixty (60) days after the Approval Date of this Agreement, or at CLEC's request, all

published Subscriber List Information (including such information that resides in Sprint's master subscriber system/accounts master file for the purpose of publishing directories in any format as specified by the Act) via an electronic data transfer medium and in a mutually agreed to format, on the same terms and conditions and at the same rates that the Sprint provides Subscriber List Information to itself or to other third parties. All changes to the Subscriber List Information shall be provided to CLEC pursuant to a mutually agreed format and schedule. Both the initial List and all subsequent Lists shall indicate for each subscriber whether the subscriber is classified as residence or business class of service.

6.8.1.1.2. CLEC shall provide directory listings to Sprint pursuant to the directory listing and delivery requirements in the approved OBF format, at a mutually agreed upon timeframe. Other formats and requirements shall not be used unless mutually agreed to by the parties.

6.9. Listing Types

LISTED	The listing information is available for all directory requirements.
NON-LISTED	The listing information is available to all directory requirements, but the information does not appear in the published street directory.
NON-PUBLISHED	A directory service may confirm, by name and address, the presence of a listing, but the telephone number is not available. The listing information is not available in either the published directory or directory assistance.

ATTACHMENT VIII
REPORTING STANDARDS

1. GENERAL

- 1.1. Sprint shall satisfy all service standards, intervals, measurements, specifications, performance requirements, technical requirements, and performance standards (Performance Standards) that are specified in this agreement or are required by law or regulation. In addition, Sprint's performance under this Agreement shall be provided to CLEC will be at Parity with the performance Sprint provides itself for like service(s).
- 1.2. Sprint and CLEC agree that generally remedies at law alone are adequate to compensate CLEC for any failures to meet the Performance Standard requirements specified in this Agreement, or for failures to provide Customer Usage Data in accordance with this Agreement. However, CLEC shall have the right to seek injunctive relief and other equitable remedies to require Sprint (i) to cause the service ordered by CLEC to meet the Performance Standards specified by the Agreement, (ii) install or provision service ordered by CLEC within the Due Dates specified in this Agreement and (iii) to provide Customer Usage Data in accordance with this Agreement.
- 1.3. Sprint and CLEC agree that all financial remedies available to end-user and access customers for same or like services will be offered to CLEC. At such time that state or federal commission-approved credits/financial remedies are put in place between Sprint and any of its CLEC customers, Sprint would renegotiate this arrangement where such arrangements exist.

2. PARITY AND QUALITY MEASUREMENTS

- 2.1. Sprint will develop self-reporting capabilities comparing Sprint results with CLEC results for the following measures of service parity within six (6) months, but no later than December 31, 1998, of the Effective Date:
 - 2.1.1. Percentage of Commitment Times Met - Service Order
 - 2.1.2. Percentage of Commitment Times Met - Trouble Report
 - 2.1.3. Trouble Reports per 100 Access Lines (Resale only)
 - 2.1.4. Percent Repeated Trouble Reports
 - 2.1.5. Average Receive to Clear
 - 2.1.6. Percentage of Installed Orders without Repair in the first five (5) days
- 2.2. In the event CLEC chooses to utilize the Sprint operator service platform the following measures will be implemented within six (6) months of the date of first use by CLEC:
 - 2.2.1. Average Toll Answer Time; and

2.2.2. Average Directory Assistance Answer Time.

2.3. All above measures will be implemented in a manner that is consistent with the current measures Sprint makes of its own performance.