



RECEIVED-FPSC

00 MAY -4 PM 4:40

Susan S. Masterton
Attorney

Law/External Affairs
Post Office Box 2214
Tallahassee, FL 32318-2214
Voice 850 599 1560
Fax 850 878 0777
susan.masterton@mail.sprint.com

RECORDS AND
REPORTING

May 4, 2000

Ms. Blanca S. Bayo, Director
Division of Records and Reporting
Florida Public Service Commission
2540 Shumard Oak Boulevard
Tallahassee, Florida 32399-0850

000550-TP

RE: Notice of Adoption of ITC^DeltaCom Communications, Inc./Sprint
Interconnection Agreement by NET-tel Corporation (NET-tel)

Dear Ms. Bayo:

Sprint-Florida, Incorporated hereby provides notice to the Florida Public Service Commission of the adoption by NET-tel Corporation (NET-tel), of the Interconnection and Resale Agreement for the State of Florida entered into by and between Sprint-Florida Incorporated and ITC^DeltaCom Communications, Inc. and approved by the Commission on January 11, 1999. NET-tel Corporation (NET-tel), is adopting the agreement as provided by Section 252(i) of the Telecom Act of 1996. Enclosed is the original signed and five (5) copies of the agreement between Sprint-Florida and NET-tel Corporation (NET-tel) for your records.

Thank you for your assistance in this matter. If you have any questions, please do not hesitate to contact me at (850) 599-1560.

Sincerely,

Susan S. Masterton

Enclosures

DOCUMENT NUMBER-DATE
05624 MAY-48
FPSC-RECORDS/REPORTING

Master Network Interconnection and Resale Agreement

This Network Interconnection and Resale Agreement ("Agreement") between NET-tel Corporation (NET-tel) and Sprint-Florida, Incorporated (Sprint), herein collectively, "the Parties", is entered into this 10th day of April, 2000 for the State of Florida and is effective upon this date or the date of Commission approval if required.

NOW THEREFORE, the parties agree as follows:

The Parties agree that the Agreement between the Parties shall consist of the Interconnection and Resale Agreement for the State of Florida entered into by and between Sprint and ITC^DeltaCom Communications, Inc. d/b/a ITC^DeltaCom amended as follows:

TERM:

This agreement shall be in force until the 2nd day of October 2000. Pursuant to Section 3.3, this shall operate as written notice to NET-tel that Sprint will be terminating this Agreement on October 2, 2000.

RATES:

All rates provided under this agreement will include any more recently tariffed rates and previous amendments executed by Sprint and ITC^DeltaCom Communications, Inc. d/b/a ITC^DeltaCom.

CONDITIONS:

All services provided under this agreement will be consistent with the decisions of courts having jurisdiction over this agreement, including but not limited to the decisions of the Court of Appeals and the United States Supreme Court.

In Attachment III, Article 5, add a new Section 5.3.2 as follows:

- 5.3.2 If NET-tel requests an ADSL loop, for which the effective loop length exceeds the ADSL standard of 18 kft (subject to gauge design used in an area), Sprint will only provide a Non-Standard Data Line. Additional non-recurring charges for engineering and load coil removal will apply, plus trip charges and any applicable maintenance charges. Non-Standard Data Lines will not be subject to the performance measurements included in the interconnection agreement.

NOTICES:

Except as otherwise provided, all notices and other communication hereunder shall be deemed to have been duly given when made in writing and delivered in person or deposited in the United States mail, certified mail, postage paid, return receipt requested and addressed as follows:

To NET-tel: James K. Dize
 Secretary and General Counsel
 NET-tel Corporation
 1023 31st Street, N.W.
 Washington, D.C. 20007
 Telephone: (202) 295-6611
 Fax: (202) 295-6611

To Sprint: Vice-President - Carrier Services
 Mailstop: KSOPHM0316-3B925
 Sprint
 6480 Sprint Parkway
 Overland Park, KS 66251
 Facsimile: 913-315-0627

NET-tel Corporation is hereby substituted in the Sprint and ITC^DeltaCom - FL Agreement for ITC^DeltaCom Communications, Inc. d/b/a ITC^DeltaCom. The Agreement shall be modified as identified above and in all other respects the ITC^DeltaCom/Sprint FL Agreement shall remain unchanged.

IN WITNESS WHEREOF, the Parties hereto have caused this Agreement to be executed by their duly respective authorized representatives.

Sprint-Florida, Incorporated

NET-tel Corporation

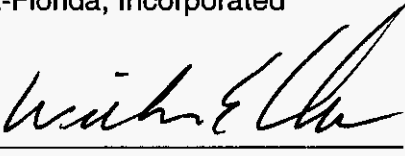
By: 

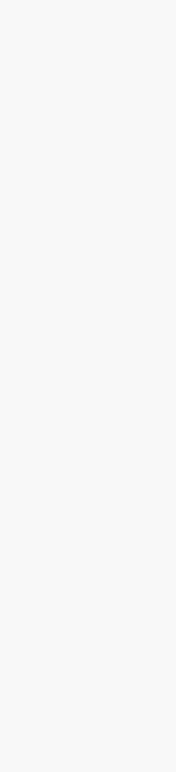
By: 

Name: William E. Cheek

Name: James K. Dize

Title: VP-Sales & Account Mgmt

Title: General Counsel

Date: 4/10/00

Date: April 3, 2000

INTERCONNECTION AND RESALE AGREEMENT

By and between

Sprint-Florida, Incorporated

and

**ITC^DeltaCom Communications, Inc. d/b/a
ITC^DeltaCom**

October 2, 1998

Table of Contents

	<u>Page No.</u>
PART A - INTERCONNECTION AND RESALE AGREEMENT.....	1
PART A – GENERAL TERMS AND CONDITIONS	1
Section 1. Scope of this Agreement.....	1
Section 2. Regulatory Approvals.....	3
Section 3. Term and Termination.....	5
Section 4. Charges and Payment	6
Section 5. Audits and Examinations.....	6
Section 6. Bona Fide Request Process for Further Unbundling.....	8
Section 7. Intellectual Property Rights	9
Section 8. Limitation of Liability	9
Section 9. Indemnification	10
Section 10. Remedies.....	12
Section 11. Branding.....	12
Section 12. Confidentiality and Publicity.....	13
Section 13. Warranties	15
Section 14. Assignment and Subcontract	15
Section 15. Governing Law.....	16
Section 16. Relationship of Parties.....	16
Section 17. No Third Party Beneficiaries	16
Section 18. Notices	16
Section 19. Waivers.....	17
Section 20. Survival	17
Section 21. Force Majeure	17
Section 22. Dispute Resolution.....	18
Section 23. Taxes	20
Section 24. Responsibility for Environmental Hazards	20
Section 25. Amendments and Modifications	22
Section 26. Severability	23
Section 27. Headings Not Controlling.....	23
Section 28. Entire Agreement	23
Section 29. Counterparts	23
Section 30. Successors and Assigns.....	23
Section 31. Implementation Plan	23
Section 32. Federal Jurisdictional Areas	26

PART B – DEFINITIONS.....	27
PART C - ATTACHMENT I - PRICE SCHEDULE.....	39
1. General Principles	39
2. Local Service Resale	39
3. Interconnection and Reciprocal Compensation	39
4. Unbundled Network Elements.....	40
PART C - ATTACHMENT II - LOCAL RESALE	41
Section 1. Telecommunications Services Provided for Resale.....	41
Section 2. General Terms and Conditions	41
2.1 Pricing	41
2.2 Requirements for Specific Services	41
2.2.1 CENTREX Requirements	41
2.2.2 Voluntary Federal and State Subscriber Financial Assistance Programs	42
2.2.3 Grandfathered Services.....	43
2.2.4 N11 Service	43
2.2.5 Contract Service Arrangements, Special - Arrangements, and Promotions	43
2.2.6 COCOT Lines	44
2.2.7 Voice Mail Service	44
2.2.8 Hospitality Service	44
2.2.9 LIDB Administration.....	44
PART C - ATTACHMENT III - NETWORK ELEMENTS	46
Section 1. General	46
Section 2. Unbundled Network Elements.....	46
2.3 Standards for Network Elements.....	47
Section 3. Loop.....	47
3.1 Definition	47
3.2 Digital Loops	47
Section 4. Local Switching	49
4.1 Definition	49
4.2 Technical Requirements.....	49
4.3 Interface Requirements	50
Section 5. Directory Assistance Service	51
Section 6. Operator Services	51
Section 7. Transport.....	52
7.1 Common Transport.....	52
7.2 Dedicated Transport.....	52

Section 8. Tandem Switching.....	53
8.1 Definition	53
8.2 Technical Requirements.....	53
8.3 Interface Requirements	54
Section 9. Network Interface Device.....	54
9.1 Definition	54
9.2 Technical Requirements.....	55
Section 10. Signaling Systems and Databases	56
10.1 Signaling Systems.....	56
10.2 Line Information Database (LIDB).....	60
10.3 Toll Free Number Database.....	61
Part C - ATTACHMENT IV - INTERCONNECTION.....	62
Section 1. Local Interconnection Trunk Arrangement.....	62
Section 2. Compensation Mechanisms	63
2.1 Point of Interconnection	63
2.2 Compensation for Local Traffic Transport and Termination	63
Section 3. Signaling	64
Section 4. Network Servicing	65
4.1 Trunk Forecasting	65
4.2 Grade of Service	67
4.3 Trunk Servicing	67
Section 5. Network Management	67
5.1 Protective Protocols	67
5.2 Expansive Protocols.....	67
5.3 Mass Calling.....	67
Section 6. Usage Measurement.....	68
Section 7. Transit Traffic.....	68
7.1 Definition	68
7.2. Terms and Conditions	69
7.3. Payment Terms and Conditions	69
7.4 Billing Records and Exchange of Data.....	69
Section 8. Responsibilities of the Parties.....	70
PART C - ATTACHMENT V - COLLOCATION.....	72
Section 1 Introduction	72
Section 2 Technical Requirements	72
Section 3 Physical Security.....	90
Section 4 License.....	93
Section 5 Technical References	93

PART C - ATTACHMENT VI - RIGHTS OF WAY (ROW), CONDUITS, POLE ATTACHMENTS.....	95
Section 1. Introduction	95
Section 2. Definitions	95
Section 3. Requirements.....	97
3.1 General	97
3.2 Pre-Ordering Disclosure Requirements	98
3.3 Attachment Requests.....	99
3.4 Authority to Place Attachments	101
3.5 Capacity	102
3.6 Sharing of Right of Way	103
3.7 Emergency Situations	103
3.8 Attachment Fees	104
3.9 Additions and Modifications to Existing Attachments.....	104
3.10 Noncompliance.....	105
3.11 Surveys and Inspections of Attachments	105
3.12 Notice of Modification or Alteration of Poles, Ducts, Conduits, or Other ROW by Sprint.....	106
3.13 Termination of Section 3 or An Individual Attachment by CLEC	106
3.14 Abandonment	107
3.15 Dispute Resolution Procedures.....	107
 PART C - ATTACHMENT VII - INTERIM NUMBER PORTABILITY	 108
Section 1. Sprint Provision of Interim Number Portability	108
Section 2. Interim Number Portability (INP)	108
Section 3. Requirements for INP.....	110
3.1 Cut-Over Process.....	110
3.2 Testing	110
3.3 Installation Timeframes	111
3.4 Call Referral Announcements	111
3.5 Engineering and Maintenance	111
3.6 Operator Services and Directory Assistance.....	112
3.7 Number Reservation	112
 PART C - ATTACHMENT VIII - GENERAL BUSINESS REQUIREMENTS .	 113
Section 1. General Business Requirements	113
1.1 Procedures.....	113
1.2 Service Offerings.....	114

Section 2. Ordering and Provisioning	116
2.1 General Business Requirements.....	116
2.2 Service Order Process Requirements.....	118
2.3 Systems Interfaces and Information Exchanges	123
2.4 Standards.....	127
Section 3. Billing	130
3.1 Procedures.....	130
3.2 Revenue Protection.....	131
Section 4. Provision of Subscriber Usage Data.....	132
4.1 Procedures.....	132
4.2 Information Exchange and Interfaces.....	137
Section 5. General Network Requirements.....	137
Section 6. Miscellaneous Services and Functions.....	141
6.0 General	141
6.1 General Requirements	141
6.2 Systems Interfaces and Exchanges	164
6.3 Systems Security.....	172
 PART C - ATTACHMENT IX - Reporting Standards.....	 173
 Section 1. General	 173
Section 2. Parity and Quality Measurements	173

PART A

INTERCONNECTION AND RESALE AGREEMENT

This Interconnection and Resale Agreement (the "Agreement"), entered into this 2nd day of October, 1998, is entered into by and between ITC^DeltaCom Communications, Inc., d/b/a ITC^DeltaCom ("CLEC"), an Alabama corporation, and Sprint-Florida, Incorporated ("Sprint"), a Florida corporation, to establish the rates, terms and conditions for local interconnection, local resale, and purchase of unbundled network elements (individually referred to as the "service" or collectively as the "services").

WHEREAS, the Parties wish to interconnect their local exchange networks in a technically and economically efficient manner for the transmission and termination of calls, so that customers of each can seamlessly receive calls that originate on the other's network and place calls that terminate on the other's network, and for CLEC's use in the provision of exchange access ("Local Interconnection"); and

WHEREAS, CLEC wishes to purchase Telecommunications Services for resale to others, and Sprint is willing to provide such service; and

WHEREAS, CLEC wishes to purchase unbundled network elements, ancillary services and functions and additional features ("Network Elements"), and to use such services for itself or for the provision of its Telecommunications Services to others, and Sprint is willing to provide such services; and

WHEREAS, the Parties intend the rates, terms and conditions of this Agreement, and their performance of obligations thereunder, to comply with the Communications Act of 1934, as amended by the Telecommunications Act of 1996 (the "Act"), the Rules and Regulations of the Federal Communications Commission ("FCC"), and the orders, rules and regulations of the Florida Public Service Commission (the "Commission");

Now, therefore, in consideration of the terms and conditions contained herein, CLEC and Sprint hereby mutually agree as follows:

PART A – GENERAL TERMS AND CONDITIONS

Section 1. Scope of this Agreement

1.1 This Agreement, including Parts A, B, and C, specifies the rights and obligations of each party with respect to the establishment, purchase, and sale of Local Interconnection, resale of Telecommunications Services and Unbundled Network Elements. This PART A sets forth the general terms

and conditions governing this Agreement. Certain terms used in this Agreement shall have the meanings defined in PART B – DEFINITIONS, or as otherwise elsewhere defined throughout this Agreement. Other terms used but not defined herein will have the meanings ascribed to them in the Act, in the FCC's, and in the Commission's Rules and Regulations. PART C sets forth, among other things, descriptions of the services, pricing, technical and business requirements, and physical and network security requirements.

LIST OF ATTACHMENTS COMPRISING PART C:

- I. Price Schedule
- II. Local Resale
- III. Network Elements
- IV. Interconnection
- V. Collocation
- VI. Rights of Way
- VII. Number Portability
- VIII. General Business Requirements
- IX. Reporting Standards

1.2 Sprint shall not discontinue any interconnection arrangement, Telecommunications Service, or Network Element provided or required hereunder without providing CLEC thirty (30) days' prior written notice of such discontinuation of such service, element or arrangement. Sprint agrees to cooperate with CLEC with any transition resulting from such discontinuation of service and to minimize the impact to customers, which may result from such discontinuance of service.

1.3 Sprint shall provide notice of network changes and upgrades in accordance with Sections 51.325 through 51.335 of Title 47 of the Code of Federal Regulations.

1.4 The services and facilities to be provided to CLEC by Sprint in satisfaction of this Agreement may be provided pursuant to Sprint tariffs and then current practices. Should there be a conflict between the terms of this Agreement and any such tariffs and practices, the terms of the tariff shall control to the extent allowed by law or Commission order. Both Parties agree that service effecting obligations undertaken pursuant to this Agreement in Part C; Attachment II, Attachment III, IV, V, VI, and VII are material obligations.

Section 2. Regulatory Approvals

2.1 This Agreement, and any amendment or modification hereof, will be submitted to the Commission for approval in accordance with Section 252 of the Act. Sprint and CLEC shall use their best efforts to obtain approval of this Agreement by any regulatory body having jurisdiction over this Agreement and to make any required tariff modifications in their respective tariffs, if any. CLEC shall not order services under this Agreement before Approval Date except as may otherwise be agreed in writing between the Parties. In the event any governmental authority or agency rejects any provision hereof, the Parties shall negotiate promptly and in good faith such revisions as may reasonably be required to achieve approval.

2.2 The Parties acknowledge that the respective rights and obligations of each Party as set forth in this Agreement are based on the texts of the Act and the rules and regulations promulgated thereunder by the FCC and the Commission as of the Effective Date. In the event of any amendment of the Act, or any final legislative, regulatory, judicial order, rule or regulation or other legal action that revises or reverses the Act, the FCC's First Report and Order in CC Docket No. 96-98 and 95-185 or any applicable Commission order or arbitration award purporting to apply the provisions of the Act, either party may, by providing written notice to the other Party, require that the affected provisions be renegotiated in good faith and this Agreement be amended accordingly to reflect the pricing, terms and conditions of each such Amendment to the Act relating to any of the provisions in this Agreement. The revised Agreement shall have an effective date that coincides with the effective date of the original legislative, judicial, FCC or Commission action giving rise to such negotiations unless the Parties agree otherwise. The Parties agree that the rates, terms, and conditions of any new Agreement shall not be applied retroactively to any period prior to such effective date except to the extent such retroactive effect is expressly required by legislative, judicial, FCC or Commission decision, rule, regulation, or preemption. In the event the Parties cannot agree on an amendment within thirty (30) days (or as otherwise mutually agreed by the Parties) from the date any such legislation, judicial action, rules, regulations or orders become effective, then the Parties shall resolve their dispute under the applicable procedures set forth in Section 22 (Dispute Resolution Procedures) hereof.

2.3 Nothing in this Agreement shall be interpreted as affecting the rights or obligations of Parties as provided in Section 252(I).

2.4 Notwithstanding the above provisions, or any other provision in this Agreement, this Agreement and any Attachments hereto are subject to such changes or modifications with respect to the rates, terms or conditions contained herein as may be ordered, allowed or directed by the Commission or the FCC, or as may be required to implement the result of an order or direction of a court of competent jurisdiction with respect to its review of any appeal of the decision of the Commission or the FCC, in the exercise of their respective jurisdictions whether said changes or modifications result from an order issued on an appeal of the decision of the Commission or the FCC, a rulemaking proceeding, a generic investigation, a tariff proceeding, a costing/pricing proceeding, or an arbitration proceeding conducted by the Commission or FCC which applies to Sprint or in which the Commission or FCC makes a generic determination to the extent that CLEC had the right and/or opportunity to participate in said proceeding (regardless of whether CLEC actually participates). Any rates, terms or conditions thus developed or modified shall be substituted in place of those previously in effect and shall be deemed to have been effective under this Agreement as of the effective date of the order by the court, Commission or the FCC, whether such action was commenced before or after the effective date of this Agreement. If any such modification renders the Agreement inoperable or creates any ambiguity or requirement for further amendment to the Agreement, the Parties will negotiate in good faith to agree upon any necessary amendments to the Agreement. Should the Parties be unable to reach agreement with respect to the applicability of such order or the resulting appropriate modifications to this Agreement, the Parties agree to petition such Commission to establish appropriate interconnection arrangements under sections 251 and 252 of the Act in light of said order or decision.

2.5 In the event Sprint is required by any governmental authority or agency to file a tariff or make another similar filing in connection with the performance of any action that would otherwise be governed by this Agreement, Sprint shall; (I) make reasonable efforts to provide to CLEC its proposed tariff prior to such filing, and (II) take all steps reasonably necessary that do not conflict with such governmental authority or agency requirement to ensure that such tariff or other filing imposes obligations upon Sprint that are as close as possible to those provided in this Agreement and preserve for CLEC the full benefit of the rights otherwise provided in this Agreement. The other services covered by this Agreement and not covered by such decision or order shall remain unaffected and shall remain in full force and effect.

2.6 The Parties intend that any additional services requested by either party relating to the subject matter of this Agreement will be incorporated into this Agreement by amendment.

Section 3. Term and Termination

3.1 This Agreement shall be deemed effective upon the Approval Date. No order or request for services under this Agreement shall be processed until this Agreement is so approved unless otherwise agreed to, in writing by the Parties.

3.2 Except as provided herein, Sprint and CLEC agree to provide service to each other on the terms defined in this Agreement for a period two years, and thereafter the Agreement shall continue in force and effect unless and until terminated as provided herein.

3.3 Either party may terminate this Agreement at the end of the term by providing written notice of termination to the other party, such written notice to be provided at least 180 days in advance of the date of termination. In the event of such termination pursuant to this Section 3.3, for service arrangements made available under this Agreement and existing at the time of termination, these arrangements shall continue without interruption under either (a) a new agreement executed by the Parties, or (b) standard interconnection terms and conditions contained in Sprint's tariff or other substitute document that are approved and made generally effective by the Commission of the FCC.

3.4 In the event of default, the non-defaulting Party may terminate this Agreement in whole or in part provided that the non-defaulting Party so advises the defaulting Party in writing of the event of the alleged default and the defaulting Party does not remedy the alleged default within 60 days after written notice thereof. Default is defined to include:

a. Either Party's insolvency or initiation of bankruptcy or receivership proceedings by or against the Party; or

b. Either Party's material breach of any of the terms or conditions hereof, including the failure to make any undisputed payment when due.

3.5 Termination of this Agreement for any cause shall not release either Party from any liability which at the time of termination has already accrued to the other Party or which thereafter may accrue in respect to any act or omission prior to termination or from any obligation which is expressly stated herein to survive termination.

3.6 If Sprint sells or trades substantially all the assets used to provide Telecommunications Services, Local Interconnection, or Network Elements in a particular exchange or group of exchanges Sprint shall provide ITC^DeltaCom ninety (90) days prior written notice. Sprint will not take any action to hinder ITC^DeltaCom's Interconnection Agreement with Sprint's successor. Sprint agrees to provide ITC^DeltaCom with notice of the proposed sale or trade within five (5) business days of the announcement of the transaction.

Section 4. Charges and Payment

4.1 In consideration of the services provided by Sprint under this Agreement, CLEC shall pay the charges set forth in Attachment I subject to the provisions of Section 2.3 hereof. The billing and payment procedures for charges incurred by CLEC hereunder are set forth in Attachment VIII.

4.2 In addition to any other applicable charges under this Section 4 and Attachment I, if CLEC purchases unbundled local switching elements, CLEC shall pay Sprint for intrastate toll minutes of use traversing such unbundled Local Switching elements, intrastate carrier common line and interconnection charges as outlined on Attachment I hereto and any explicit intrastate universal service mechanism based on access charges.

4.3 Sprint will not accept any new or amended orders for Telecommunications Services, Unbundled Network Elements, Interconnection or other services under the terms of this Agreement from CLEC while any past due, undisputed charges remain unpaid.

Section 5. Audits and Examinations

5.1 As used herein "Audit" shall mean a comprehensive review of services performed under this Agreement; "Examination" shall mean an inquiry into a specific element of or process related to services performed under this Agreement (e.g., examination and verification of LOAs). Either party (the "Requesting Party") may perform one (1) Audit per 12-month period commencing with the Effective Date. The Requesting Party may perform Examinations, as it deems necessary.

5.2 Upon thirty (30) days written notice by the Requesting Party to Audited Party, Requesting Party shall have the right through its authorized representative to make an Audit or Examination, during normal business hours, of any records, accounts and processes which contain information bearing upon the provision of the services provided and performance standards agreed to under this Agreement. Within the

above-described 30-day period, the Parties shall reasonably agree upon the scope of the Audit or Examination, the documents and processes to be reviewed, and the time, place and manner in which the Audit or Examination shall be performed. Audited Party agrees to provide Audit or Examination support, including appropriate access to and use of Audited Party's facilities (e.g., conference rooms, telephones, copying machines).

5.3 Each party shall bear its own expenses in connection with the conduct of the Audit or Examination. The reasonable cost of special data extraction required by the Requesting Party to conduct the Audit or Examination would be paid for by the Requesting Party. For purposes of this Section 5.3, a "Special Data Extraction" shall mean the creation of an output record or informational report (from existing data files) that is not created in the normal course of business. If any program is developed to Requesting Party's specifications and at Requesting Party's expense, Requesting Party shall specify at the time of request whether the program is to be retained by Audited party for reuse for any subsequent Audit or Examination.

5.4 Adjustments, credits or payments shall be made and any corrective action shall commence within thirty (30) days from Requesting Party's receipt of the final audit report to compensate for any errors or omissions which are disclosed by such Audit or Examination and are agreed to by the Parties. One and one half (1 ½%) or the highest interest rate allowable by law for commercial transactions shall be assessed and shall be computed by compounding monthly from the time of the overcharge to the day of payment or credit. The Party responsible for the error shall either forego interest if they underbilled the other Party, or pay interest if they were responsible for the other Party's underbilling. Party is defined in Part B.

5.5 Neither such right to examine and audit nor the right to receive an adjustment shall be affected by any statement to the contrary appearing on checks or otherwise, unless such statement expressly waiving such right appears in writing, is signed by the authorized representative of the party having such right and is delivered to the other party in a manner sanctioned by this Agreement.

5.6 This Section 5 shall survive expiration or termination of this Agreement for a period of two (2)-years after expiration or termination of this Agreement.

Section 6. Bona Fide Request Process for Further Unbundling

6.1 Each Party shall promptly consider and analyze access to categories of unbundled Network Elements not covered in this Agreement with the submission of a Network Element Bona Fide Request hereunder. The Network Element Bona Fide Request process set forth herein does not apply to those services requested pursuant to FCC Rule Section 51.319 adopted in First Report & Order, CC Docket No. 96-98, (rel. Aug. 8, 1996).

6.2 A Network Element Bona Fide Request shall be submitted in writing to the individual referenced in Section 18 and shall include a technical description of each requested Network Element.

6.3 The requesting Party may cancel a Network Element Bona Fide Request at any time, but shall pay the other Party's reasonable and demonstrable costs of processing and/or implementing the Network Element Bona Fide Request up to the date of cancellation.

6.4 Within ten (10) business days of its receipt, the receiving Party shall acknowledge receipt of the Network Element Bona Fide Request.

6.5 Except under extraordinary circumstances, within thirty (30) days of its receipt of a Network Bona Fide Request, the receiving Party shall provide to the requesting Party a preliminary analysis of such Network Element Bona Fide Request. The preliminary analysis shall confirm that the receiving Party will offer access to the Network Element or will provide a detailed explanation that access to the Network Element does not qualify as a Network Element that is required to be provided under the Act.

6.6 Upon receipt of the preliminary analysis, the requesting Party shall, within thirty (30) days, notify the receiving Party of its intent to proceed or not to proceed.

6.7 The receiving Party shall promptly proceed with the Network Element Bona Fide Request upon receipt of written authorization from the requesting Party. When it receives such authorization, the receiving Party shall promptly develop the requested services, determine their availability, calculate the applicable prices and establish installation intervals.

6.8 As soon as feasible, but not more than ninety (90) days after its receipt of authorization to proceed with developing the Network Element Bona Fide Request, the receiving Party shall provide to the requesting Party a Network Element Bona Fide Request quote which will include, at a minimum, a description of each Network Element, the availability, the applicable rates (developed in accordance with Pricing Methods that the Commission has approved for Sprint) and the installation intervals.

6.9 Within thirty (30) days of its receipt of the Network Element Bona Fide Request quote, the requesting Party must either confirm its order for the Network Bona Fide Request pursuant to the Network Element Bona Fide Request quote or seek resolution pursuant to the Dispute Resolution procedures of Section 22. This however does not prevent either party from seeking arbitration by the Commission pursuant to Section 252 of the Act.

6.10 If a Party to a Network Element Bona Fide Request believes that the other Party is not requesting, negotiating or processing the Network Element Bona Fide Request in good faith, or disputes a determination, or price or cost quote, such Party may seek mediation or arbitration by the Commission pursuant to Section 252 of the Act or may invoke the dispute resolution provisions of this Agreement in Section 22.

Section 7. Intellectual Property Rights

Any intellectual property that originates from or is developed by a Party shall remain in the exclusive ownership of that Party. Except for a limited license to use patents or copyrights to the extent necessary for the Parties to use any facilities or equipment (including software) or to receive any service solely as provided under this Agreement, no license in patent, copyright, trademark or trade secret, or other proprietary or intellectual property right now or hereafter owned, controlled or licensable by a Party, is granted to the other Party or shall be implied or arise by estoppel.

Section 8. Limitation of Liability

Neither Party shall be responsible to the other Party for any indirect, special, consequential or punitive damages, including (without limitation) damages for loss of anticipated profits or revenue or other economic loss in connection with or arising from anything said, omitted, or done hereunder (collectively "Consequential Damages"), whether arising in contract or tort, provided that the foregoing shall not limit a Party's obligation under Section 9 to indemnify, defend, and hold the other party harmless against amounts payable to third parties.

8.1 With respect to any claim or suit, whether based in contract, tort or any other theory of legal liability, by CLEC, any CLEC customer or by any other person or entity, for damages associated with any of the services provided by Sprint pursuant to or in connection with this Agreement, including but not limited to the installation, provision, preemption, termination, maintenance, repair or restoration of service, and subject to the provisions of this Section 8, Sprint's liability shall be limited to an amount equal to the proportionate charge for the service provided pursuant to this Agreement for the period during which the service was affected. Notwithstanding the foregoing, claims for damages by CLEC, any CLEC customer, or any other person or entity resulting from the gross negligence or willful misconduct of Sprint shall not be subject to such limitation of liability as expressed in this paragraph 8.1

Section 9. Indemnification

9.1 Each Party agrees to indemnify and hold harmless the other Party from and against claims for damage to tangible personal or real property and/or personal injuries arising out of the negligence or willful act or omission of the indemnifying Party or its agents, servants, employees, contractors or representative. To the extent not prohibited by law, each Party shall defend, indemnify, and hold the other Party harmless against any loss to a third party arising out of the negligence or willful misconduct by such indemnifying Party, its agents, or contractors in connection with its provision of service or functions under this Agreement. In the case of any loss alleged or made by a Customer of either Party, the Party whose customer alleged such loss shall indemnify the other Party and hold it harmless against any or all of such loss alleged by each and every Customer. The indemnifying Party under this Section agrees to defend any suit brought against the other Party either individually or jointly with the indemnified Party for any such loss, injury, liability, claim or demand.

The indemnified Party agrees to notify the other Party promptly, in writing, of any written claims, lawsuits, or demands for which it is claimed that the indemnifying Party is responsible under this Section and to cooperate in every reasonable way to facilitate defense or settlement of claims. The indemnifying Party shall have complete control over defense of the case and over the terms of any proposed settlement or compromise thereof. The indemnifying Party shall keep the Indemnified Party reasonably and timely apprised of the status of the claim, demand or lawsuit. The indemnifying Party shall not be liable under this Section for settlement by the indemnified Party of any claim, lawsuit, or demand, if the indemnifying Party has not approved the settlement in advance, unless the indemnifying Party has had the defense of the claim, lawsuit, or demand tendered to it in writing and has failed to assume such defense. In the event of such failure to assume defense, the indemnifying Party shall be liable for any reasonable settlement made by the indemnified Party without approval of the indemnifying Party.

9.2 Each Party agrees to indemnify and hold harmless the other Party from all claims and damages arising from the Indemnifying Party's discontinuance of service to one of the Indemnifying Party's subscribers for nonpayment.

9.3 When the lines or services of other companies and Carriers are used in establishing connections to and/or from points not reached by a Party's lines, neither Party shall be liable for any act or omission of the other companies or Carriers.

9.4 In addition to its indemnity obligations hereunder, each Party shall, to the extent allowed by law or Commission Order, provide, in its tariffs and contracts with its subscribers that relate to any Telecommunications Services or Network Element provided or contemplated under this Agreement, that in no case shall such Party or any of its agents, contractors or others retained by such Party be liable to any subscriber or third party for (i) any loss relating to or arising out of this Agreement, whether in contract or tort, that exceeds the amount such Party would have charged the applicable subscriber for the service(s) or function(s) that gave rise to such loss, and (ii) Consequential Damages (as defined in Section 8 above).

Section 10. Remedies

10.1 In addition to any other rights or remedies, and unless specifically provided here and to the contrary, either Party may sue in equity for specific performance.

10.2 Except as otherwise provided herein, all rights of termination, cancellation or other remedies prescribed in this Agreement, or otherwise available, are cumulative and are not intended to be exclusive of other remedies to which the injured Party may be entitled at law or equity in case of any breach or threatened breach by the other Party of any provision of this Agreement, and use of one or more remedies shall not bar use of any other remedy for the purpose of enforcing the provisions of this Agreement.

Section 11. Branding

11.1 In all cases of operator and directory assistance services CLEC provides using services provided by Sprint under this Agreement, Sprint shall, where technically feasible, at CLEC's sole discretion and expense, brand any and all such services at all points of customer contact exclusively as CLEC services, or otherwise as CLEC may specify, or be provided with no brand at all, as CLEC shall determine. Sprint shall provide, to CLEC the methods and procedures to be used by Sprint to assure that Sprint meets CLEC's branding requirements for such Operator and Directory Assistance Services. Sprint may not unreasonably interfere with branding by CLEC; provided that if there are technical limitations as to the number of CLECs that Sprint can brand for, branding will be made available to CLEC hereunder on a first come, first serve basis with an allowance for an unbranded alternative for all Telecommunications Carriers.

11.2 CLEC shall provide the exclusive interface to CLEC subscribers, except, as CLEC shall otherwise specify. In those instances where CLEC requests Sprint personnel to interface with CLEC subscribers, such Sprint personnel shall inform the CLEC subscribers that they are representing CLEC or such brand as CLEC may specify.

11.3 All forms, business cards or other business materials furnished by Sprint to CLEC subscribers shall bear no corporate name, logo, trademark or tradename.

11.4 Except as specifically permitted by a Party, in no event shall either Party provide information to the other Party's subscribers about the other Party or the other Party's products or services.

11.5 Sprint shall provide, for CLEC's review, the methods and procedures, training and approaches to be used by Sprint to assure that Sprint meets CLEC's branding requirements.

11.6 This Section 11 shall not confer on either Party any rights to the service marks, trademarks and trade names owned by or used in connection with services by the other Party, except as expressly permitted in writing by the other Party.

Section 12. Confidentiality and Publicity

12.1 All confidential or proprietary information disclosed by either Party during the negotiations and the term of this Agreement shall be protected by the Parties in accordance with the terms of this Section 12. All information which is disclosed by one party ("Disclosing Party") to the other ("Recipient") in connection with this Agreement, or acquired in the course of performance of this Agreement, shall be deemed confidential and proprietary to the Disclosing Party and subject to this Agreement, such information including but not limited to, orders for services, usage information in any form, and "CPNI", and the rules and regulations of the FCC ("Confidential and/or Proprietary Information").

12.1.1 For a period of three (3) years from receipt of Confidential Information, Recipient shall (i) use it only for the purpose of performing under this Agreement, (ii) hold it in confidence and disclose it only to employees or agents who have a need to know it in order to perform under this Agreement, and (iii) safeguard it from unauthorized use or Disclosure using no less than the degree of care with which Recipient safeguards its own Confidential Information.

12.1.2 Recipient shall have no obligation to safeguard Confidential Information (i) which was in the Recipient's possession free of restriction prior to its receipt from Disclosing Party, (ii) which becomes publicly known or available through no breach of this Agreement by Recipient, (iii) which is rightfully acquired by Recipient free of restrictions on its Disclosure, or (iv) which is independently developed by personnel of Recipient to whom the Disclosing Party's Confidential Information had not been previously disclosed. Recipient may disclose Confidential Information if required by law, a court, or governmental agency, provided that Disclosing Party has been notified of the requirement promptly after Recipient becomes aware of the requirement, and provided

that Recipient undertakes all lawful measures to avoid disclosing such information until Disclosing Party has had reasonable time to obtain a protective order. Recipient agrees to comply with any protective order that covers the Confidential Information to be disclosed.

12.1.3 Each Party agrees that Disclosing Party would be irreparably injured by a breach of this Section 12 by Recipient or its representatives and that Disclosing Party shall be entitled to seek equitable relief, including injunctive relief and specific performance, in the event of any breach of this Section 12. Such remedies shall not be exclusive, but shall be in addition to all other remedies available at law or in equity.

12.2 Unless otherwise mutually agreed upon, neither Party shall publish or use the other Party's logo, trademark, service mark, name, language, pictures, or symbols or words from which the other Party's name may reasonably be inferred or implied in any product, service, advertisement, promotion, or any other publicity matter, except that nothing in this paragraph shall prohibit a Party from engaging in valid comparative advertising. This paragraph 12.2 shall confer no rights on a Party to the service marks, trademarks and trade names owned or used in connection with services by the other Party or its Affiliates, except as expressly permitted by the other Party.

12.3 Neither Party shall produce, publish, or distribute any press release or other publicity referring to the other Party or its Affiliates, or to this Agreement, without the prior written approval of the other Party. Written approval shall not be unreasonably withheld. Each party shall obtain the other Party's prior approval before discussing this Agreement in any press or media interviews. In no event shall either Party mischaracterize the contents of this Agreement in any public statement or in any representation to a governmental entity or member thereof.

12.4 Except as otherwise expressly provided in this Section 12, nothing herein shall be construed as limiting the rights of either Party with respect to its customer information under any applicable law, including without limitation Section 222 of the Act.

12.5 Except as otherwise expressly provided in this Section 12, nothing herein shall be construed as limiting the rights of either Party with respect to its customer information under any applicable law, including without limitation Section 222 of the Act.

12.6 Except as otherwise expressly provided in this Section 12, nothing herein shall be construed as limiting the rights of either Party with respect to its customer information under any applicable law, including without limitation Section 222 of the Act.

Section 13. Warranties

13.1 Except as otherwise provided herein, each Party shall perform its obligations hereunder at a performance level at Parity with that which it uses for its own operations, or those of its Affiliates, but in no event shall a party use less than reasonable care in the performance of its duties hereunder. Each Party warrants that it shall perform its obligations under this Agreement in accordance with the Telecommunications Act of 1996 and applicable federal and state orders, rules, and regulations.

13.2 The Bellcore, ANSI and other such standards referred to in this Agreement and the Attachments and Appendices hereto, are guidelines established to inform the telecommunications industry about equipment specifications. Bellcore, ANSI, and other standards bodies do not warrant or guarantee that following the specifications set forth in such standards will produce the technical results or safety originally intended. Each Party agrees to adhere to the technical requirements contained in the Bellcore, ANSI and other standards referred to herein, provided that the applicable standards will be those existing at the time the equipment to which the standards refer is placed into service by Sprint. With respect to such standards, Sprint agrees to provide CLEC Parity for the functionality offered by Sprint pursuant to this Agreement. Sprint makes no representation or warranty, express or implied, with respect to the sufficiency, accuracy or utility of any information or opinion contained in the Bellcore, ANSI, and other such standards referred to in this Agreement, and the Attachments and Appendices hereto.

Section 14. Assignment and Subcontract

14.1 Any assignment by either Party to any non-affiliated entity of any right, obligation or duty or of any other interest hereunder, in whole or in part, without the prior written consent of the other Party shall be void. A Party assigning this Agreement or any right, obligation, duty or other interest hereunder to an Affiliate shall provide written notice to the other Party. All obligations and duties of any party under this Agreement shall be binding on all successors in interest and assigns of such Party. No assignment hereof shall relieve the assignor of its obligations under this Agreement.

14.2 If any obligation is performed by a subcontractor or Affiliate, Sprint shall remain fully responsible for the performance of this Agreement in accordance with its terms. CLEC may notify Sprint of the actions of a subcontractor in the event CLEC reasonably believes such subcontractor is not properly performing services hereunder. Sprint shall inform CLEC of action taken by Sprint in response to the CLEC's notification of a subcontractor's improper performance of services

Section 15. Governing Law

This Agreement shall be governed by and construed in accordance with the Act, orders of the Commission, and the FCC's Rules and Regulations, except insofar as state law may control any aspect of this Agreement, in which case the domestic laws of the State of Florida, without regard to its conflicts of laws principles, shall govern. In all other respects, in the event of a conflict between the provisions of this Agreement and the Act, the provisions of the Act shall govern.

Section 16. Relationship of Parties

It is the intention of the Parties that Sprint be an independent contractor and nothing contained herein shall constitute the Parties as joint venturers, partners, employees or agents of one another, and neither Party shall have the right or power to bind or obligate the other.

Section 17. No Third Party Beneficiaries

The provisions of this Agreement are for the benefit of the Parties hereto and not for any other person, provided, however, that this shall not be construed to prevent CLEC from providing its Telecommunications Services to other carriers. This Agreement shall not provide any person not a party hereto with any remedy, claim, liability, reimbursement, claim of action, or other right in excess of those existing without reference hereto.

Section 18. Notices

Except as otherwise provided herein, all notices or other communication hereunder shall be deemed to have been duly given when made in writing and delivered in person or deposited in the United States mail, certified mail, postage prepaid, return receipt requested and addressed as follows:

To CLEC: ITC^DeltaCom
Christopher J. Rozycki
Director of Regulatory Affairs
700 Boulevard South, Suite 101
Huntsville, Alabama 35802

To Sprint:: Sprint-Florida, Incorporated
Field Service Manager
MC: FLAPKA 0202
555 Lake Border Drive
Apopka, FL 32703

If personal delivery is selected to give notice, a receipt of such delivery shall be obtained. The address to which notices or communications may be given to either party may be changed by written notice given by such Party to the other pursuant to this Section 18.

Section 19. *Waivers*

19.1 No waiver of any provisions of this Agreement and no consent to any default under this Agreement shall be effective unless the same shall be in writing and properly executed by or on behalf of the Party against whom such waiver or consent is claimed.

19.2 No course of dealing or failure of any Party to strictly enforce any term, right, or condition of this Agreement in any instance shall be construed as a general waiver or relinquishment of such term, right or condition.

19.3 Waiver by either party of any default by the other Party shall not be deemed a waiver of any other default.

Section 20. *Survival*

The following provisions of this Part A shall survive the expiration or termination of this Agreement: Sections 4, 5, 7, 8, 9, 10, 11.6, 12, 22, 23 and 24.

Section 21. *Force Majeure*

21.1 Neither Party shall be held liable for any delay or failure in performance of any part of this Agreement from any cause beyond its control and without its fault or negligence, such as acts of God, acts of civil or military authority, embargoes, epidemics, war, terrorist acts, riots, insurrections, fires, explosions, earthquakes, nuclear accidents, floods, power blackouts, strikes, work stoppage affecting a supplier or unusually severe weather. No delay or other failure to perform shall be excused pursuant to this Section 21 unless delay or failure and consequences thereof are beyond the control and without the fault or negligence of the Party claiming excusable delay or other failure to perform. In the event of any such excused delay in the performance of a Party's obligation(s) under this Agreement, the due date for the performance of the original

obligation(s) shall be extended by a term equal to the time lost by reason of the delay. In the event of such delay, the delaying Party shall perform its obligations at a performance level no less than that which it uses for its own operations. In the event of such performance delay or failure by Sprint, Sprint agrees to resume performance in a nondiscriminatory manner and not favor its own provision of Telecommunications Services above that of CLEC.

21.2 During the pendency of a general strike by Sprint's employees, Sprint shall provide Local Service and Network Elements to CLEC at Parity to the services provided by Sprint to its subscribers.

Section 22. Dispute Resolution

22.1 Except for actions seeking a temporary restraining order or an injunction, the Parties agree to employ the alternative dispute resolution provisions set forth in this section to resolve disputes arising under this Agreement. Nothing in this Section is intended to bar a Party relief in an appropriate forum for a dispute that is materially and directly related to the rights and obligations conferred or imposed on either Party by operation of the Act, or by Commission or FCC rule or order.

At the written request of a Party, each Party will appoint a knowledgeable, responsible representative to meet and negotiate in good faith to resolve a dispute arising out of this Agreement. The Parties intend that these negotiations be conducted by non-lawyer, business representatives. The location, format, frequency, duration and conclusion of these discussions shall be left to the discretion of the representatives. Upon agreement, the representatives may utilize other alternative dispute resolution procedures such as mediation to assist in the negotiations. Discussions and correspondence among the representatives for purposes of these negotiations shall be treated as developed for purposes of settlement, and shall not be admissible in any arbitration or lawsuit without the concurrence of all Parties. Documents identified in or provided with such communications, which are not prepared for purposes of the negotiations, are not so exempted and may, if otherwise discoverable, be discovered or otherwise admissible, be admitted in evidence, in any arbitration or lawsuit.

22.2 The Parties recognize and agree that the Commission has continuing jurisdiction to implement and enforce all terms and conditions of this Agreement. Accordingly, the Parties agree that any dispute arising out of or relating to this Agreement that the Parties themselves cannot resolve under the procedures described above may be submitted to the Commission for resolution. The Parties agree to seek expedited resolution by the Commission, and shall request that resolution occur in

no event later than sixty (60) days from the date of submission of such dispute. If the Commission appoints an expert(s) or other facilitator(s) to assist in its decision making, each party shall pay half of the fees and expenses so incurred. During the Commission proceeding each Party shall continue to perform its obligations under this Agreement provided, however, that neither Party shall be required to act in any unlawful fashion. This provision shall not preclude the Parties from seeking relief available in any other forum.

22.3 If any portion of an amount due to a Party ("the Billing Party") under this Agreement is subject to a bona fide dispute between the Parties, the Party billed (the "Non-Paying Party") shall within (30) thirty days of its receipt of the invoice containing such disputed amount give written notice to the Billing Party of the amounts it disputes ("Disputed Amounts") and include in such written notice the specific details and reasons for disputing each item. The Non-Paying Party shall pay when due all undisputed amounts to the Billing Party. The balance of the Disputed Amount shall thereafter be paid with appropriate late charges, if appropriate, upon final determination of such dispute.

22.4 If the Parties are unable to resolve the issues related to the Disputed Amounts in the normal course of business within thirty (30) days after delivery to the Billing Party of notice of the Disputed Amounts, each of the Parties shall appoint a designated representative that has authority to settle the dispute and that is at a higher level of management than the persons with direct responsibility for administration of this Agreement. The designated representatives shall meet as often as they reasonably deem necessary in order to discuss the dispute and negotiate in good faith in an effort to resolve such dispute. The specific format for such discussions will be left to the discretion of the designated representatives, however all reasonable requests for relevant information made by one Party to the other Party shall be honored.

22.5 If the Parties are unable to resolve issues related to the Dispute Amounts within thirty (30) days after the Parties' appointment of designated representatives pursuant to subsection 22.1, then either Party may file a complaint with the Commission to resolve such issues or proceed with any other remedy pursuant to law or equity. The Commission may direct payment of any or all funds plus applicable late charges to be paid to either Party.

22.6 In the event Sprint overcharges or underbills CLEC for services rendered pursuant to this Agreement, upon discovery, either Party may request a credit or payment for the billing error within twelve months of the date of the statement which contained the error. In the event, CLEC

overcharges or underbills Sprint for services rendered pursuant to this Agreement, upon discovery, either Party may request a credit or payment for the billing error within twelve months of the date of statement which contained the error. The Parties shall continue providing service to each other during the pendency of any dispute resolution procedure and making payments, and the Parties shall continue to perform their obligations in accordance with this Agreement.

Section 23. Taxes

Any Federal, state or local excise, license, sales, use, or other taxes or tax-like charges (excluding any taxes levied on income) resulting from the performance of this Agreement shall be borne by the Party upon which the obligation for payment is imposed under applicable law, even if the obligation to collect and remit such taxes is placed upon the other party. Any such taxes shall be shown as separate items on applicable billing documents between the Parties. The Party obligated to collect and remit taxes shall do so unless the other Party provides such Party with the required evidence of exemption. The Party so obligated to pay any such taxes may contest the same in good faith, at its own expense, and shall be entitled to the benefit of any refund or recovery, provided that such party shall not permit any lien to exist on any asset of the other party by reason of the contest. The Party obligated to collect and remit taxes shall cooperate fully in any such contest by the other Party by providing records, testimony and such additional information or assistance as may reasonably be necessary to pursue the contest.

Section 24. Responsibility for Environmental Hazards

24.1 CLEC shall in no event be liable to Sprint for any costs whatsoever resulting from the presence or release of any Environmental Hazard that CLEC did not cause or introduce to the affected work location. Sprint hereby releases, and shall also indemnify, defend (at CLEC's request) and hold harmless CLEC and each of CLEC's officers, directors and employees from and against any losses and expenses that arise out of or result from (i) any Environmental Hazard that Sprint, its contractors or its agents introduce to the work locations or (ii) any other presence or release of any Environmental Hazard at any work location, except as provided in Section 24.2 of this Part A; provided that in the event that after CLEC notifies Sprint that CLEC, its employees, contractors or agents plan to enter a Sprint work location and prior to CLEC or its employees, contractors or agents entering a work location Sprint fully informs CLEC in writing of an Environmental Hazard at such work location then Sprint shall not be obligated to indemnify CLEC for losses and expenses arising out

of injuries to CLEC employees, contractors or agents resulting from their exposure to such Environmental Hazard except to the extent such injuries are exacerbated by the acts of Sprint or its employees, contractors, or agents.

24.2 Prior to CLEC or its employees, contractors, or agents introducing an Environmental Hazard into a work location, CLEC shall fully inform Sprint in writing of its planned actions at such work location and shall receive Sprint's written permission for such actions and CLEC warrants that it shall comply with all legal and regulatory obligations it has with respect to such Environmental Hazard and notices it is required to provide with respect thereto. Sprint shall in no event be liable to CLEC for any costs whatsoever resulting from the presence or release of any Environmental Hazard that CLEC causes or introduces to the affected work location. CLEC shall indemnify, defend (at Sprint's request) and hold harmless Sprint and each of Sprint's officers, directors and employees from and against any losses and expenses that arise out of or result from any Environmental Hazard that CLEC, its contractors or its agents cause or introduce to the work location. CLEC shall be responsible for obtaining, including payment of associated fees, all environmental permits, licenses and/or registrations required for environmental hazards CLEC causes or introduces to the affected work location.

24.3 In the event any suspect material within Sprint-owned, operated or leased facilities are identified to be asbestos-containing, CLEC will, at CLECs expense, notify Sprint before commencing any activities and ensure that to the extent any activities which it undertakes in the facility disturb any asbestos-containing materials (ACM) or presumed asbestos containing materials (PACM) as defined in 29 CFR Section 1910.1001, such CLEC activities shall be undertaken in accordance with applicable local, state and federal environmental and health and safety statutes and regulations. Except for abatement activities undertaken by CLEC or equipment placement activities that result in the generation or disturbance of asbestos containing material, CLEC shall not have any responsibility for managing, nor be the owner of, not have any liability for, or in connection with, any asbestos containing material. Both Parties agree to immediately notify the other if the Party undertakes any asbestos control or asbestos abatement activities that potentially could affect CLEC equipment or operations, including, but not limited to, contamination of equipment.

24.4 Within ten (10) business days of CLEC's request for any space in Sprint owned or controlled facility, Sprint shall provide any information in its possession regarding the known environmental conditions of the space provided for placement of equipment and interconnection including, but not limited to, the existence and condition of known hazardous levels of friable asbestos, lead paint, hazardous substance contamination, or hazardous levels of radon. Information is considered in a Party's possession under this Agreement if it is in such Party's possession, or the possession of a current employee of Sprint's, contractor, or agent. The Parties shall cooperate to obtain such information regarding environmental conditions.

24.5 If the space provided for the placement of equipment, interconnection, or provision of service contains known environmental contamination or hazardous material, particularly but not limited to hazardous levels of friable asbestos, lead paint or hazardous levels of radon, which makes the placement of such equipment or interconnection hazardous, Sprint shall offer an alternative space, if available, for CLEC's consideration. If interconnection is complicated by the presence of environmental contamination or hazardous materials, and an alternative route is available, Sprint shall make such alternative route available for CLEC's consideration. If there is no alternative or CLEC declines same, and CLEC occupies the hazardous space, CLEC does so at its own risk and shall indemnify Sprint from all liability for damages or injury arising from the presence of the environmental contamination or hazardous materials.

24.6 Subject to this Section 24 and to Sprint's standard security procedures, which procedures will be provided to CLEC, Sprint shall allow CLEC at CLEC's expense to perform any environmental site investigations, including, but not limited to, asbestos surveys, which CLEC deems to be necessary in support of its collocation needs.

Section 25. Amendments and Modifications

No provision of this Agreement shall be deemed waived, amended or modified by either party unless such a waiver, amendment or modification is in writing, dated, and signed by both Parties.

Section 26. Severability

Subject to Section 2 - Regulatory Approvals, if any part of this Agreement is held to be invalid for any reason, such invalidity will affect only the portion of this Agreement which is invalid. In all other respects this Agreement will stand as if such invalid provision had not been a part thereof, and the remainder of the Agreement shall remain in full force and effect.

Section 27. Headings Not Controlling

The headings and numbering of Sections, Parts and Attachments in this Agreement are for convenience only and shall not be construed to define or limit any of the terms herein or affect the meaning or interpretation of this Agreement.

Section 28. Entire Agreement

This Agreement, including all Parts and Attachments and subordinate documents attached hereto or referenced herein, all of which are hereby incorporated by reference herein, constitute the entire matter thereof, and supersede all prior oral or written agreements, representations, statements, negotiations, understandings, proposals, and undertakings with respect to the subject matter thereof.

Section 29. Counterparts

This Agreement may be executed in counterparts. Each counterpart shall be considered an original and such counterparts shall together constitute one and the same instrument.

Section 30. Successors and Assigns

This Agreement shall be binding upon, and inure to the benefit of, the Parties hereto and their respective successors and permitted assigns.

Section 31. Implementation Plan

31.1 Implementation Team. This Agreement sets forth the overall standards of performance for services, processes, and systems capabilities that the Parties will provide to each other, and the intervals at which those services, processes and capabilities will be provided. The Parties understand that the arrangements and provision of services described in this Agreement shall require technical and operational coordination between the Parties.

Accordingly, the Parties agree to form a team (the "Implementation Team") that shall develop and identify those processes, guidelines, specifications, standards and additional terms and conditions necessary to support the terms of this Agreement. Within thirty (30) days after the Effective Date, each Party shall designate, in writing, no more than four (4) persons to be permanent members of the Implementation Team; provided that either Party may include in meetings or activities such technical specialists or other individuals as may be reasonably required to address a specific task, matter or subject. Each Party may replace its representatives by delivering written notice thereof to the other Party.

31.2 Implementation Plan. Within ninety (90) days after the Effective Date, the agreements reached by the Implementation Team shall be documented in an operations manual (the "Implementation Plan"). The Implementation Plan shall address the following matters, and may include any other matters agreed upon by the Implementation Team:

31.2.1 the respective duties and responsibilities of the Parties with respect to the administration and maintenance of the interconnections (including signaling) specified in Attachment 3 and the trunk groups specified in Attachment 4 and, including standards and procedures for notification and discoveries of trunk disconnects;

31.2.2 disaster recovery and escalation provisions;

31.2.3 access to Operations Support Systems functions provided hereunder, including gateways and interfaces;

31.2.4 escalation procedures for ordering, provisioning, billing, and maintenance;

31.2.5 single points of contact for ordering, provisioning, billing, and maintenance;

31.2.6 service ordering and provisioning procedures, including provision of the trunks and facilities;

31.2.7 provisioning and maintenance support;

31.2.8 conditioning and provisioning of collocation space and maintenance of Virtually Collocated equipment;

31.2.9 procedures and processes for Directories and Directory Listings;

31.2.10 service referral procedures, including procedures for handling misdirected inquiries and calls and procedures for handling out-of-service or irate Customers;

31.2.11 training;

31.2.12 billing processes and procedures;

31.2.13 network planning components including time intervals, and planning SONET equipment configuration, fiber hand-off, test and acceptance of SONET ring, trunking, signaling, and augment process;

31.2.14 joint systems readiness and operational readiness plans;

31.2.15 appropriate testing of services, equipment, facilities and Network Elements;

31.2.16 monitoring of inter-company operational processes;

31.2.17 procedures for coordination of local PIC changes and processing;

31.2.18 physical and network security concerns;

31.2.19 such other matters specifically referenced in this Agreement that are to be agreed upon by the Implementation Team and/or contained in the Implementation Plan;

31.2.20 information regarding reporting and levels of content for performance benchmark records; and

31.2.21 Performance Standards.

31.3 Action of the Implementation Team. The Implementation Plan may be amended from time to time by the Implementation Team as the team deems appropriate. Unanimous written consent of the permanent members of the Implementation Team shall be required for any action of the Implementation Team. If the Implementation Team is unable to act, the existing provisions of the Implementation Plan shall remain in full force and effect.

Section 32. Federal Jurisdictional Areas

CLEC agrees it will not market to or attempt to secure any customer located in an area having exclusive federal jurisdiction, such as a fort, without providing to Sprint written authorization from the appropriate federal entity allowing the CLEC to provide service to this area.

IN WITNESS WHEREOF, each of the Parties has caused this Agreement to be executed by its duly authorized representatives.

ITC^DeltaCom Communications, Inc.
d/b/a ITC^DeltaCom

Sprint-Florida, Incorporated

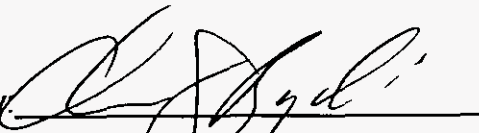
By: 
Name: Christopher J. Rozycki
Title: Director of Regulatory Affairs
Date: 10/2/98

By: JESSICA BELING
Name: Jessica Beling
Title: Director
Date: 10/1/98

FORM
ANB
APPROVED

PART B -- DEFINITIONS

"911 SITE ADMINISTRATOR" is a person assigned by CLEC to establish and maintain E911 service location information for its subscribers.

"911 SERVICE" means a universal telephone number which gives the public direct access to the Public Safety Answering Point (PSAP). Basic 911 service collects 911 calls from one or more local exchange switches that serve a geographic area. The calls are then sent to the correct authority designated to receive such calls.

"ADSL" or **"Asymmetrical Digital Subscriber Line"** means a transmission technology which transmits an asymmetrical digital signal using one of a variety of line codes.

"ASR" (**ACCESS SERVICE REQUEST**) means the industry standard forms and supporting documentation used for ordering Access Services. The ASR may be used to order trunking and facilities between CLEC and Sprint for Local Interconnection.

"ACCESS SERVICES" refers to interstate and intrastate switched access and private line transport services.

"ACT" means the Communications Act of 1934 as amended by the Telecommunications Act of 1996, Public Law 104-104 of the 104th U.S. Congress, effective February 8, 1996, and as from time to time interpreted in the duly authorized rules and regulations of the FCC or the Commission having authority to interpret the Act within its state of jurisdiction.

"AFFILIATE" is an entity that directly or indirectly owns or controls, is owned or controlled by, or is under common ownership or control with, another entity. In this paragraph, "own" or "control" means to own an equity interest (or equivalent) of at least 10% with respect to either party, or the right to control the business decisions, management and policy of another entity.

"APPROVAL DATE" is the date on which Commission approval of the Agreement is granted.

"GATEWAY" (**ALI GATEWAY**) is a telephone company computer facility that interfaces with CLEC's 911 administrative site to receive Automatic Location Identification (ALI) data from CLEC. Access to the Gateway will be via a dial-up modem using a common protocol.

"AMA" means the Automated Message Accounting structure inherent in switch technology that initially records telecommunication message information. AMA format is contained in the Automated Message Accounting document, published by Bellcore as GR-1100-CORE which defines the industry standard for message recording.

"ALI" (AUTOMATIC LOCATION IDENTIFICATION) is a feature developed for E911 systems that provides for a visual display of the caller's telephone number, address and the names of the emergency response agencies that are responsible for that address. The Competitive Local Exchange Company will provide ALI record information in National Emergency Number Association (NENA) Version #2 format. The ALI also shows an Interim Number Portability (INP) number if applicable.

"ALI/DMS" (AUTOMATIC LOCATION IDENTIFICATION/DATA MANAGEMENT SYSTEM) means the emergency service (E911/911) database containing subscriber location information (including name, address, telephone number, and sometimes special information from the local service provider) used to determine to which Public Safety Answering Point (PSAP) to route the call.

"ANI" (AUTOMATIC NUMBER IDENTIFICATION) is a feature that identifies and displays the number of a telephone line that originates a call.

"ARS" (AUTOMATIC ROUTE SELECTION) means a service feature associated with a specific grouping of lines that provides for automatic selection of the least expensive or most appropriate transmission facility for each call based on criteria programmed into the system.

"BLV/BLI" (BUSY LINE VERIFY/BUSY LINE INTERRUPT) means an operator call in which the caller inquires as to the busy status of, or requests an interruption of a call on another subscriber's telephone line.

"BUSINESS DAY(S)" means the days of the week excluding Saturdays, Sundays, and all legal holidays.

"CABS" means the Carrier Access Billing System which is defined in a document prepared under the direction of the Billing Committee of the OBF. The Carrier Access Billing System document is published by Bellcore in Volumes 1, 1A, 2, 3, 3A, 4 and 5 as Special Reports SR-OPT-001868, SR-OPT-001869, SR-OPT-001871, SR-OPT-001872, SR-OPT-001873, SR-OPT-001874, and SR-OPT-001875, respectively, and contains the recommended guidelines for the billing of access and other connectivity services. Sprint's carrier access billing system is its Carrier Access Support System (CASS). CASS mirrors the requirements of CABS.

"CPN" (CALLING PARTY NUMBER) is a Common Channel Signaling parameter which refers to the number transmitted through the network identifying the calling party.

"CENTRAL OFFICE SWITCH" or "CENTRAL OFFICE" means a switching entity within the public switched network, including but not limited to end office switches and Tandem Office Switches. Central office switches may be employed as combination End Office/Tandem Office Switches (Combination Class 5/Class 4).

"CENTREX" means a Telecommunications Service associated with a specific grouping of lines that uses central office switching equipment for call routing to handle direct dialing of calls, and to provide numerous private branch exchange-like features.

"CHARGE NUMBER" is a CCS parameter which refers to the number transmitted through the network identifying the billing number of the calling party.

"CLASS" (Bellcore Service Mark) – means service features that utilize the capability to forward a calling party's number between end offices as part of call setup. Features include Automatic Callback, Automatic Recall, Caller ID, Call Trace, and Distinctive Ringing.

"CLEC" means a Competitive Local Exchange Carrier.

"COLLOCATION" means the right of CLEC to place equipment in the Sprint's central offices or other Sprint locations. This equipment may be placed via either a physical or virtual collocation arrangement. With physical collocation, CLEC obtains dedicated space to place and maintain its equipment. With virtual collocation, Sprint will install and maintain equipment that CLEC provides to Sprint.

"COMMISSION" means the Florida Public Service Commission.

"COMMON TRANSPORT" provides a local interoffice transmission path between the Sprint Tandem Switch and a Sprint or CLEC end office switch. Common Transport is shared between multiple customers and is required to be switched at the Tandem.

"CCS" (COMMON CHANNEL SIGNALING) means a method of digitally transmitting call set-up and network control data over a digital signaling network fully separate from the public switched telephone network that carries the actual call.

"CONFIDENTIAL AND/OR PROPRIETARY INFORMATION" has the meaning set forth in Section 21 of Part A – General Terms.

"CONTRACT YEAR" means a twelve (12) month period during the term of the contract commencing on the Approval Date and each anniversary thereof.

"CONTROL OFFICE" is an exchange carrier center or office designated as its company's single point of contact for the provisioning and maintenance of its portion of local interconnection arrangements.

"CROSS CONNECTION " means a connection provided pursuant to Collocation at the Digital Signal Cross Connect, Main Distribution Frame or other suitable frame or panel between (i) the Collocating Party's equipment and (ii) the equipment or facilities of the Housing Party.

"CUSTOM CALLING FEATURES" – means a set of Telecommunications Service features available to residential and single-line business customers including call-waiting, call-forwarding and three-party calling.

"CUSTOMER PROPRIETARY NETWORK INFORMATION ("CPNI") - means (A) information that relates to the quantity, technical configuration, type, destination, and amount of use of a Telecommunications Service subscribed to by any customer of a Telecommunications Carrier, and that is made available to the carrier by the customer solely by virtue of the carrier customer relationship; and (B) information contained in the bills pertaining to telephone exchange service or telephone toll service received by a customer of a carrier.

"DBMS" (DATABASE MANAGEMENT SYSTEM) is a computer process used to store, sort, manipulate and update the data required to provide selective routing and ALI.

"DEDICATED TRANSPORT" provides a local interoffice transmission path between Sprint and/or CLEC central offices. Dedicated Transport is limited to the use of a single customer and does not require switching at a Tandem.

"DIALING PARITY" is As Defined in the Act. As used in the Agreement, Dialing Parity refers to both Local Dialing Parity and Toll Dialing Parity. "Local Dialing Parity" means the ability of Telephone Exchange Service Customers of one LEC to place local calls to Telephone Exchange Service Customers of another LEC, without the use of any access code and with no unreasonable dialing delay. "Toll Dialing Parity" means the ability of Telephone Exchange Service Customers of a LEC to have their toll calls (inter or intraLATA) routed to a toll carrier (intraLATA or interLATA) of their selection without dialing access codes or additional digits and with no unreasonable dialing delay.

"DIGITAL SIGNAL LEVEL" means one of several transmission rates in the time-division multiplex hierarchy.

"DIGITAL SIGNAL LEVEL 0" or "DSO" means the 64 kbps zero-level signal in the time-division multiplex hierarchy.

"DIGITAL SIGNAL LEVEL 1" or "DS1" means the 1.544 Mbps first-level signal in the time-division multiplex hierarchy. In the time-division multiplexing hierarchy of the telephone network, DS 1 is the initial level of multiplexing.

"DIGITAL SIGNAL LEVEL 3" or "DS3" MEANS THE 44.736 Mbps third-level in the time-division multiplex hierarchy. In the time-division multiplexing hierarchy of the telephone network, DS3 is defined as the third level of multiplexing.

"DIRECTORY ASSISTANCE DATABASE" refers to any subscriber record used by Sprint in its provision of live or automated operator-assisted directory assistance including but not limited to 411, 555-1212, NPA-555-1212.

"DIRECTORY ASSISTANCE SERVICES" provides listings to callers. Directory Assistance Services may include the option to complete the call at the caller's direction.

"DISCLOSER" means that party to this Agreement which has disclosed Confidential Information to the other party.

"E911" (ENHANCED 911 SERVICE) means a telephone communication service which will automatically route a call dialed "911" to a designated public safety answering point (PSAP) attendant and will provide to the attendant the calling party's telephone number and, when possible, the address from which the call is being placed and the emergency response agencies responsible for the location from which the call was dialed.

"E911 MESSAGE TRUNK" is a dedicated line, trunk or channel between two central offices or switching devices which provides a voice and signaling path for E911 calls.

ELECTRONIC INTERFACES - means access to operations support systems consisting of preordering, ordering, provisioning, maintenance and repair and billing functions. For the purposes of this Agreement, Sprint shall provide Electronic Interfaces in accordance with Part C – Attachment VIII, Section 2.3 of this agreement.

"EMERGENCY RESPONSE AGENCY" is a governmental entity authorized to respond to requests from the public to meet emergencies.

"ENVIRONMENTAL HAZARD" means any substance the presence, use, transport, abandonment or disposal of which (i) requires investigation, remediation, compensation, fine or penalty under any Applicable Law (including, without limitation, the Comprehensive Environmental Response Compensation and Liability Act, Superfund Amendment and Reauthorization Act, Resource Conservation Recovery Act, the Occupational Safety and Health Act and provisions with similar purposes in applicable foreign, state and local jurisdictions) or (ii) poses risks to human health, safety or the environment (including, without limitation, indoor, outdoor or orbital space environments) and is regulated under any Applicable Law.

"ESN" (EMERGENCY SERVICE NUMBER) is a number assigned to the ALI and selective routing databases for all subscriber telephone numbers. The ESN designates a unique combination of fire, police and emergency medical service response agencies that serve the address location of each in-service telephone number.

"EMR" means the Exchange Message Record System for exchanging telecommunications message information for billable, non-billable, sample, settlement and study data. EMR format is contained in BR-010-200-010 CRIS Exchange Message Record, published by Bellcore and which defines the industry standard for exchange message records.

"ENHANCED DIRECTORY ASSISTANCE" refers to directory Assistance services, including but not limited to reverse search, talking yellow pages, and locator services.

"EIS" (EXPANDED INTERCONNECTION SERVICE) is the collocation arrangement which Sprint provides in its designated wire centers.

"GRANDFATHERED SERVICE" means service which is no longer available for new customers and is limited to the current customer at their current locations with certain provisioning limitations, including but not limited to upgrade denials, feature adds/changes and responsible/billing party.

"FIBERMEET" means an Interconnection architecture method whereby the Parties physically interconnect their networks via an optical fiber interface (as opposed to an electrical interface) at a mutually agreed upon location.

"FCC INTERCONNECTION ORDER" is the Federal Communications Commission's First Report and Order and Second Report and Order in CC Docket No. 96-98 released August 8, 1996; as subsequently amended or modified by the FCC from time to time.

"HDSL" or "High-Bit Rate Digital Subscriber Line" means a transmission technology which transmits up to a DS1-level signal, using any one of the following line codes: 2 Binary/1 Quaternary ("2B1Q"), Carrierless AM/PM, Discrete Multitone ("DMT"), or 3 Binary/1 Octet ("3B10").

"ILEC" means the incumbent local exchange carrier.

"IXC" (INTEREXCHANGE CARRIER) means a provider of interexchange telecommunications services.

"INP" (INTERIM NUMBER PORTABILITY) is a service arrangement whereby subscribers who change local service providers may retain existing telephone numbers without impairment of quality, reliability, or convenience when remaining at their current location or changing their location within the geographic area served by the initial carrier's serving central office. (Notwithstanding the foregoing, the parties acknowledge that the provision of INP through Remote Call Forwarding results in a lesser grade of service.)

"INTEGRATED DIGITAL LOOP CARRIER" means a subscriber loop carrier system which integrates within the switch at a DS1 level that is twenty-four (24) local Loop transmission paths combined into a 1.544 Mbps digital signal.

"INTERCONNECTION" is As Described in the Act and refers to the connection of separate pieces of equipment, facilities, or platforms between or within networks for the purpose of transmission and routing of Telephone Exchange Service traffic or Exchange Access traffic.

"INTEGRATED SERVICES DIGITAL NETWORK" or "ISDN" means a switched network service that provides end-to-end digital connectivity for the simultaneous transmission of voice and data. Basic Rate Interface-ISDN (BRI-ISDN) provides for a digital transmission of two 64 kbps bearer channels and one 16 kbps data channel (2B+D).

"LIDB" (LINE INFORMATION DATA BASE(S)) means a Service Control Point (SCP) database that provides for such functions as calling card validation for telephone line number cards issued by Sprint and other entities and validation for collect and billed-to-third services.

"LOCAL SERVICE REQUEST" means an industry standard form used by the Parties to add, establish, change or disconnect local services.

"LOCAL TRAFFIC" means traffic (excluding Commercial Mobile Radio Services traffic, e.g., paging, cellular, PCS) that is originated and terminated within a given local calling area, or mandatory expanded area service (EAS) area, as defined by State commissions or, if not defined by state commissions, then as defined in existing Sprint and ITC^DeltaCom tariffs.

A "LOOP" is a transmission path between the main distribution frame cross-connect, or its equivalent, in a Sprint Central Office or wire center, and up to the network interface device at a customer's premises. This includes, but is not limited to, two-wire and four-wire copper analog voice-grade loops, two-wire and four-wire loops that are conditioned to transmit the digital signals needed to provide services such as ISDN and DS1-level signals. This also includes other mediums, such as DS-3, OC-n and STS-n services (e.g. n=1,3,12...).

"MSAG" (MASTER STREET ADDRESS GUIDE (MSAG)) is a database defining the geographic area of an E911 service. It includes an alphabetical list of the street names, high-low house number ranges, community names, and emergency service numbers provided by the counties or their agents to Sprint.

"E911 DATABASE RECORDS" are the CLEC subscriber records to be provided to Sprint for inclusion in Sprint's E911 database.

"MECAB" refers to the Multiple Exchange Carrier Access Billing (MECAB) document prepared by the Billing Committee of the Ordering and Billing Forum (OBF), which functions under the auspices of the Carrier Liaison Committee (CLC) of the Alliance for Telecommunications Industry Solutions (ATIS). The MECAB document, published by Bellcore as Special Report SR-BDS-000983, contains the recommended guidelines for the billing of an access service provided by two or more LECs (including a LEC and a CLEC), or by one LEC in two or more states within a single LATA.

"MECOD" refers to the Multiple Exchange Carriers Ordering and Design (MECOD) Guidelines for Access Services - Industry Support Interface, a document developed by the Ordering/Provisioning Committee under the auspices of the Ordering and Billing Forum (OBF), which functions under the auspices of the Carrier Liaison Committee (CLC) of the Alliance for Telecommunications Industry Solutions (ATIS). The MECOD document, published by Bellcore as Special Report SR STS-002643, establishes recommended guidelines for processing orders for access service which is to be provided by two or more LECs (including a LEC and a CLEC).

"MEET-POINT BILLING" OR "MB" refers to the billing arrangement for the interconnection of facilities between two or more LECs for the routing of traffic to and from another interexchange carrier.

"NANP" means the "North American Numbering Plan," the system or method of telephone numbering employed in the United States, Canada, and certain Caribbean countries. It denotes the three digit Numbering Plan Area code and a seven digit telephone number made up of a three digit Central Office code plus a four digit station number.

"NENA" (NATIONAL EMERGENCY NUMBER ASSOCIATION (NENA)) is an association with a mission to foster the technological advancement, availability and implementation of 911 nationwide.

"NETWORK ELEMENT" means a facility or equipment used in the provision of a Telecommunications Service. Such term also includes features, functions, and capabilities that are provided by means of such facility or equipment, including subscriber numbers, databases, signaling systems, and information sufficient for billing and collection or used in the transmission, routing, or other provision of a Telecommunications Service.

"NP" (NUMBER PORTABILITY) means the ability of users of Telecommunications Services to retain, at the same location, existing telecommunications numbers without impairment of quality, reliability, or convenience when switching from one telecommunications carrier to another.

"NPA" (NUMBERING PLAN AREA) (sometimes referred to as an area code) is the three digit indicator which is designated by the first three digits of each 10-digit telephone number within the NANP. Each NPA contains 800 possible NXX Codes.

There are two general categories of NPA, "Geographic NPAs" and "Non-Geographic NPAs." A "Geographic NPA" is associated with a defined geographic area, and all telephone numbers bearing such NPA are associated with services provided within that Geographic area. A "Non-Geographic NPA," also known as a "Service Access Code (SAC Code)" is typically associated with a specialized telecommunications service which may be provided across multiple geographic NPA areas; 500, 800, 900, 700, and 888 are examples of Non-Geographic NPAs.

"NXX," "NXX CODE," OR "CENTRAL OFFICE CODE," OR "CO CODE" is the three digit switch entity indicator which is defined by the fourth, fifth and sixth digits of a 10 digit telephone number within the North America Numbering Plan ("NANP").

"OBF" means the Ordering and Billing Forum, which functions under the auspices of the Carrier Liaison Committee (CLC) of the Alliance for Telecommunications Industry Solutions (ATIS)

"OBSOLETE SERVICE" means a service that is outmoded/outdated but yet has current subscribers to the services. Such service is no longer available for new customers and with existing customers there is no assurance of the service continuing to function. Any technical or feature change to the customer's service will eliminate such service at the time of request.

"OPERATOR SYSTEMS" is the Network Element that provides operator and automated call handling with billing, special services, subscriber telephone listings, and optional call completion services.

"OPERATOR SERVICES" provides (1) operator handling for call completion (e.g. collect calls); (2) operator or automated assistance for billing after the subscriber has dialed the called number (e.g. credit card calls); and (3) special services (e.g. BLV/BLVI, Emergency Agency Call).

"PARITY" means, subject to the availability, development and implementation of necessary industry standard Electronic Interfaces, the provision by Sprint of services, Network Elements, functionality or telephone numbering resources under this Agreement to CLEC on terms and conditions, including provisioning and repair intervals, no less favorable than those offered to Sprint, its Affiliates or any other entity that obtains such services, Network Elements, functionality or telephone numbering resources. Until the implementation of necessary Electronic Interfaces, Sprint shall provide such services, Network Elements, functionality or telephone numbering resources on a non-discriminatory basis to CLEC as it provides to its Affiliates or any

other entity that obtains such services, Network Elements, functionality or telephone numbering resources.

"PARTIES" means, jointly, Sprint-Florida and ITC^DeltaCom Communications, Inc. d/b/a ITC^DeltaCom and no other entity, affiliate, subsidiary or assign.

"PARTY" means either Sprint-Florida or ITC^DeltaCom Communications, Inc., d/b/a ITC^DeltaCom, and no other entity, affiliate, subsidiary or assign.

"P.01 TRANSMISSION GRADE OF SERVICE (GOS)" means a trunk facility provisioning standard with the statistical probability of no more than one call in 100 blocked on initial attempt during the average busy hour.

"PLU" (PERCENT LOCAL USAGE) is a calculation which represents the ratio of the local minutes to the sum of local and intraLATA toll minutes between exchange carriers sent over Local Interconnection Trunks. Directory assistance, BLV/BLVI, 900, 976, transiting calls from other exchange carriers and switched access calls are not included in the calculation of PLU.

"POI" (POINT OF INTERCONNECTION) is a mutually agreed upon point of demarcation where the networks of Sprint and CLEC interconnect for the exchange of traffic.

"POP" means an IXC's point of presence.

"PROPRIETARY INFORMATION" shall have the same meaning as Confidential Information.

"PSAP" (PUBLIC SAFETY ANSWERING POINT (PSAP)) is the public safety communications center where 911 calls placed by the public for a specific geographic area will be answered.

"RATE CENTER" means the geographic point and corresponding geographic area which are associated with one or more particular NPA-NXX codes which have been assigned to Sprint (or CLEC) for its provision of Basic Exchange Telecommunications Services. The "rate center point" is the finite geographic point identified by a specific V&H coordinate, which is used to measure distance-sensitive end user traffic to/from the particular NPA-NXX designations associated with the specific Rate Center. The "rate center area" is the exclusive geographic area identified as the area within which Sprint (or CLEC) will provide Basic Exchange Telecommunications Services bearing the particular NPA-NXX designations associated with the specific Rate Center. The Rate Center point must be located within the Rate Center area.

"REAL TIME" means the actual time in which an event takes place, with the reporting on or the recording of the event simultaneous with its occurrence.

"RECIPIENT" means that party to this Agreement (a) to which Confidential Information has been disclosed by the other party or (b) who has obtained Confidential Information in the course of providing services under this Agreement.

"RESELLER" is a category of Local Exchange service providers who obtain dial tone and associated Telecommunications Services from another provider for resale to their end user subscribers.

"ROW" (RIGHT OF WAY (ROW)) has the meaning set forth in Section 2.13 of Attachment VI of this Agreement.

"ROUTING POINT" means a location which Sprint or CLEC has designated on its own network as the homing (routing) point for traffic inbound to Basic Exchange Services provided by Sprint or CLEC which bear a certain NPA-NXX designation. The Routing Point is employed to calculate mileage measurements for the distance-sensitive transport element charges of Switched Access Services. Pursuant to Bellcore Practice BR 795-100-100, the Routing Point may be an "End Office" location, or a "LEC Consortium Point of Interconnection." Pursuant to that same Bellcore Practice, examples of the latter shall be designated by a common language location identifier (CLLI) code with (x)KD in positions 9, 10, 11, where (x) may be any alphanumeric A-Z or 0-9. The above referenced Bellcore document refers to the Routing Point as the Rating Point. The Rating Point/Routing Point need not be the same as the Rate Center Point, nor must it be located within the Rate Center Area, but must be in the same LATA as the NPA-NXX.

"SECAB" means the Small Exchange Carrier Access Billing document prepared by the Billing Committee of the OBF. The Small Exchange Carrier Access Billing document, published by Bellcore as Special Report SR OPT-001856, contains the recommended guidelines for the billing of access and other connectivity services.

"SELECTIVE ROUTING" is a service which automatically routes an E911 call to the PSAP that has jurisdictional responsibility for the service address of the telephone that dialed 911, irrespective of telephone company exchange or wire center boundaries.

"SIGNALING TRANSFER POINT" or **"STP"** means a signaling point that performs message routing functions and provides information for the routing of messages between signaling points within or between CCIS networks. An STP transmits, receives and processes CCIS messages.

"SWITCH" means a Central Office Switch as defined in this Part B.

"SWITCHED ACCESS DETAIL USAGE DATA" means a category 1101XX record as defined in the EMR Bellcore Practice BR 010-200-010.

"SWITCHED EXCHANGE ACCESS SERVICE" means the offering of transmission or switching services to Telecommunications Carriers for the purpose of the origination or termination of Telephone Toll Service. Switched Exchange Access Services include: Feature Group A, Feature Group B, Feature Group D, 800/888 access and 900 access and their successor or similar Switched Exchange Access Services.

"SYNCHRONOUS OPTICAL NETWORK" or SONET is an optical interface standard that allows interworking of transmission products from multiple vendors (i.e. mid-span meets). The base rate is 51.84 MHps (OC-1/STS-1 and higher rates are direct multiples of the base rate up to 1.22 GHps.

"TANDEM OFFICE SWITCHES", "TANDEM", "TANDEM SWITCHING" describe Class 4 switches which are used to connect and switch trunk circuits between and among end office switches and other tandems.

"TECHNICALLY FEASIBLE" refers solely to technical or operational concerns, rather than economic, space, or site considerations.

"TELECOMMUNICATIONS" means the transmission, between or among points specified by the user, of information of the user's choosing, without change in the form or content of the information as sent and received.

"TELECOMMUNICATION SERVICES" means the offering of Telecommunications for a fee directly to the public, or to such classes of users as to be effectively available directly to the public, regardless of the facilities used.

"THOUSANDS BLOCK OF NUMBERS" shall mean 1000 or more consecutive numbers beginning and ending on a digit boundary, e.g., 949-1000 to 949-1999.

"TRCO" means Trouble Reporting Control Office.

"VOLUNTARY FEDERAL SUBSCRIBER FINANCIAL ASSISTANCE PROGRAMS" are government programs that subsidize the provision of Telecommunications Services to low-income subscribers, pursuant to requirements established by the appropriate state regulatory body.

"WIRE CENTER" denotes a building or space within a building which serves as an aggregation point on a given carrier's network, where transmission facilities and circuits are connected or switched. Wire center can also denote a building in which one or more central offices, used for the provision of Basic Exchange Services and access services, are located. However, for purposes of EIC service, Wire Center shall mean those points eligible for such connections as specified in the FCC Docket No. 91-141, and rules adopted pursuant thereto.

PART C - ATTACHMENT I

PRICE SCHEDULE

1. General Principles

1.1 Subject to the provisions of Section 2 of Part A of this Agreement, all rates provided under this Agreement shall remain in effect for the term of this Agreement.

2. Local Service Resale

The rates that CLEC shall pay to Sprint for Local Resale are as set forth in Table 1 of this Attachment. Table 1 is attached.

3. Interconnection and Reciprocal Compensation

3.1 The rates to be charged for the exchange of Local Traffic are set forth in Table 1 of this Attachment and shall be applied consistent with the provisions of Attachment IV of this Agreement. Table 1 is attached.

3.2 Compensation for the termination of toll traffic and the origination of 800 traffic between the interconnecting parties shall be based on the applicable access charges in accordance with FCC and Commission Rules and Regulations and consistent with the provisions of Attachment IV of this Agreement.

3.3 Where a toll call is completed through Sprint's INP ("Interim Number Portability") arrangement (e.g., remote call forwarding, flexible DID, etc.) to a CLEC's subscriber, CLEC shall be entitled to applicable access charges in accordance with the FCC and Commission Rules and Regulations. If a national standard billing method has not been developed for a CLEC to directly bill a carrier access for a toll call that has been completed using interim number portability, then a blended rate method will be used.

3.3.1 The Parties will jointly determine the amount of traffic that will be considered INP'ed traffic for compensation purposes. The ported party shall charge the porting party for each minute of INP traffic at the INP blended rate specified in section 3.3.2, in lieu of any other compensation charges for terminating such traffic. The traffic that is not identified as INP'ed will be compensated as local interconnection as set forth in section 3.1.

3.3.2 For compensation of the INP traffic, the Parties shall jointly develop a process which will allow compensation for INP'ed traffic to be based on the initial origination point and final terminated point of the INP'ed call. The full reciprocal compensation rate, as listed in the Pricing Schedule, shall apply for local traffic, and full switched access charges, as listed in applicable tariffs, shall apply for intraLATA and interLATA. All three sets of rates will be weighted together based on the agreed minutes of use patterns to establish a single set of blended rates for all INP'ed traffic.

3.4 CLEC shall pay a transit rate, comprised of the transport and tandem rate elements, as set forth in Table 1 of this Attachment when CLEC uses a Sprint access tandem to terminate a local call to a third party LEC or another CLEC. Sprint shall pay CLEC a transit rate equal to the Sprint rate referenced above when Sprint uses a CLEC switch to terminate a local call to a third party LEC or another CLEC.

4. Unbundled Network Elements

The charges that CLEC shall pay to Sprint for Unbundled Network Elements are set forth in Table 1 of this Attachment I.

PART C - ATTACHMENT II

LOCAL RESALE

Section 1. Telecommunications Services Provided for Resale

1.1 At the request of CLEC, and pursuant to the requirements of the Act, and FCC and Commission Rules and Regulations, Sprint shall make available to CLEC for resale Telecommunications Services that Sprint currently provides or may provide hereafter at retail to subscribers who are not telecommunications carriers. Such resale may be as allowed by the FCC and Commission. The Telecommunications Services provided by Sprint to CLEC pursuant to this Attachment II are collectively referred to as "Local Resale."

1.2 To the extent that this Attachment describes services which Sprint shall make available to CLEC for resale pursuant to this Agreement, this list of services is neither all inclusive nor exclusive.

Section 2. General Terms and Conditions

2.1 **Pricing.** The prices charged to CLEC for Local Resale are set forth in Exhibit One of this Agreement.

2.2 Requirements for Specific Services

2.2.1 CENTREX Requirements

2.2.1.1 At CLEC's option, CLEC may purchase the entire set of CENTREX features or a subset of any one such feature. The CENTREX Service provided for resale will meet the requirements of this Subsection 2.2.1.1.

2.2.1.2 All features and functions of CENTREX Service, including CENTREX Management System (CMS), whether offered under tariff or otherwise, shall be available to CLEC for resale.

2.2.1.3 Sprint shall make information required for an "as is" transfer of CENTREX subscriber service, features, functionalities and CMS capabilities available to CLEC.

2.2.1.4 All service levels and features of CENTREX Service provided by Sprint for resale by CLEC shall be at Parity with the service levels and features of CENTREX Service Sprint provides its subscribers.

2.2.1.5 Consistent with Sprint's tariffs, CLEC may aggregate the CENTREX local exchange, and IntraLATA traffic usage of CLEC subscribers to qualify for volume discounts on the basis of such aggregated usage. The volume discount is applied prior to the resale discount.

2.2.1.6 CLEC may request that Sprint suppress the need for CLEC subscribers to dial "9" when placing calls outside the CENTREX System. Should CLEC request this capability for its subscriber, the subscriber will not be able to use 4 digit dialing.

2.2.1.7 CLEC may resell call forwarding in conjunction with CENTREX Service.

2.2.1.8 CLEC may purchase any CENTREX Service for resale subject to the minimum number of lines required by Sprint's tariff to qualify for CENTREX Service, but otherwise without restriction on the maximum number of lines that may be purchased for such service.

2.2.1.9 Sprint shall make available to CLEC for resale intercom calling within the same CENTREX system. To the extent that Sprint offers its own subscribers intercom calling between different CENTREX systems, Sprint shall make such capability available to CLEC for resale..

2.2.1.10 CLEC may resell Automatic Route Selection ("ARS"). CLEC may aggregate multiple CLEC subscribers on dedicated access facilities where such aggregation is allowed by law, rule or regulation.

2.2.2 Voluntary Federal and State Subscriber Financial Assistance Programs

Subsidized local Telecommunications Services are provided to low-income subscribers pursuant to requirements established by the appropriate state regulatory body, and include programs such as Voluntary Federal Subscriber Financial Assistance Program and

Link-Up America. Voluntary Federal and State Subscriber Financial Assistance Programs are not Telecommunications Services that are available for resale under this Agreement. However, when a Sprint subscriber who is eligible for such a federal program or other similar state program chooses to obtain Local Resale from CLEC and CLEC serves such subscriber via Local Resale, Sprint shall identify such subscriber's eligibility to participate in such programs to CLEC in accordance with the procedures set forth herein.

2.2.3 Grandfathered Services.

Sprint shall offer for resale at wholesale prices to CLEC all Grandfathered Services solely for the existing grandfathered base. Sprint shall make reasonable efforts to provide CLEC with advance copy of any request for the termination of service and/or grandfathering to be filed by Sprint with the Commission.

2.2.4 N11 Service

2.2.4.1 Sprint agrees not to offer any new N11 Telecommunications Services after the Approval Date of this Agreement unless Sprint makes any such service available for resale.

2.2.4.2 CLEC shall have the right to resell any N11 Telecommunications Service, including but not limited to 411 or 611 services, existing as of the Approval Date. Where technically feasible, these services shall be unbranded and routed to CLEC, as required by CLEC pursuant to Part A, Section 12.

2.2.5 Contract Service Arrangements, Special Arrangements, and Promotions.

Sprint shall offer for resale all of its Telecommunications Services available at retail to subscribers who are not Telecommunications Carriers, including but not limited to Contract Service Arrangements (or ICB), Special Arrangements (or ICB), and Promotions in excess of ninety (90) days at wholesale prices, all in accordance with FCC and Commission Rules and Regulations.

2.2.6 COCOT Lines

2.2.6.1 COCOT lines will not be resold at wholesale prices under this Agreement. Should a court of competent jurisdiction or other final authority require COCOT lines to be resold at wholesale prices, this agreement shall be revised to reflect that decision or order.

2.2.7 Voice Mail Service

Voice Mail Service is not a Telecommunications Service available for resale under this Agreement. However, where available, Sprint shall make available for Local Resale the SMDI-E (Station Message Desk Interface-Enhanced), or SMDI, Station Message Desk Interface where SMDI-E is not available, feature capability allowing for Voice Mail Services. Sprint shall make available the MWI (Message Waiting Indicator) stutter dial tone and message waiting light feature capabilities. Sprint shall make available CF-B/DA (Call Forward on Busy/Don't Answer), CF/B (Call Forward on Busy), and CF/DA (Call Forward Don't Answer) feature capabilities allowing for Voice Mail services. However, should a court of competent jurisdiction rule that voice mail is a telecommunication service available for resale, Sprint shall offer voice mail under the terms and conditions specified in that ruling.

2.2.8 Hospitality Service

Sprint shall provide all blocking, screening, and all other applicable functions available for hospitality lines under tariff.

2.2.9 LIDB Administration

Sprint shall maintain customer information for CLEC customers who subscribe to resold Sprint local service dial tone lines, in Sprint's LIDB in the same manner that it maintains information in LIDB for its own similarly situated end-user subscribers. Sprint shall update and maintain, on the same schedule that it uses for its own similarly situated end-user subscribers, the CLEC information in LIDB.

Until such time as Sprint's LIDB has the software capability to recognize a resold number as CLEC's, Sprint shall store the resold number in its LIDB at no charge and shall retain revenue for LIDB look-ups to the resold number. At such time as Sprint's LIDB has the software capability to recognize that the resold number is CLEC's then, if CLEC desires to store resold numbers on Sprint's LIDB, the parties shall negotiate a separate LIDB database storage and look-up agreement.

NETWORK ELEMENT PRICE LIST - SPRINT FLORIDA

RESALE DISCOUNTS:			
Other than Operator/DA		19.40%	
Op Assist/DA		12.10%	
USAGE FILE CHARGES:			
Message Provisioning, per message		\$0.005	
Data Transmission, per message		\$0.002	
Tape Charge, per tape		\$50.00	
RATE ELEMENT	SOURCE	RECURRING RATE	NRC
	TELRIC COST STUDY		
Service Order NRC			\$25.15
Service Order Listing Only			\$20.82
Central Office Interconnection Charge			\$10.27
Trip Charge			\$18.41
Outside Plant Interconnection (2-W)			\$59.75
Outside Plant Interconnection (4-W)			\$74.72
NID Installation Charge			\$37.36
NID Connection Charge			\$18.68
Testing			\$1.42
Loop Rework Charge (2-W)			\$37.38
Loop Rework Charge (4-W)			\$62.41
Trouble Isolation and Testing			\$66.58
NID	TELRIC COST STUDY		
1 Line		\$0.91	
2 Line		\$1.09	
SmartJack		\$12.37	
HDSL RT Unit		\$24.82	
LOOP	Commission Order		
Analog 2-wire	Band 1	\$10.78	
	Band 2	\$15.41	
	Band 3	\$20.54	
	Band 4	\$27.09	
	Band 5	\$39.66	
	Band 6	\$74.05	
Analog 4-wire	Band 1	\$18.80	
	Band 2	\$26.88	
	Band 3	\$35.85	
	Band 4	\$47.24	
	Band 5	\$69.17	
	Band 6	\$129.13	
Local Switching	Commission Order		
	Band 1	\$4.44	
	Band 2	\$4.99	
	Band 3	\$5.77	
	Band 4	\$6.59	
	Band 5	\$7.40	
	Band 6	\$8.43	
	ISDN	ICB	
	CENTREX	ICB	
	PBS	ICB	
	DS1	ICB	

NETWORK ELEMENT PRICE LIST - SPRINT FLORIDA

RATE ELEMENT	SOURCE	RECURRING RATE	NRC
	TELRIC COST STUDY		
FEATURES	TELRIC COST STUDY		
CCF Package *		\$0.23	\$3.21
CLASS Package *		\$4.74	\$5.76
CENTREX Package *		\$10.47	\$36.66
- 3 Way Conf/Consult/Hold Transfer		\$1.80	\$21.12
- Conf Calling - 6 Way Station Control		\$2.35	\$31.00
- Dial Transfer to Tandem Tie Line		\$0.12	\$141.86
- Direct Connect		\$0.03	\$24.28
- Meet Me Conference		\$17.03	\$44.86
- Multi-Hunt Service		\$0.08	\$27.05
INTERIM NUMBER PORTABILITY	TELRIC COST STUDY		
RCF Residential		\$0.00	\$0.00
RCF Business		\$0.00	\$0.00
Call Path Residential		\$0.00	\$0.00
Call Path Business		\$0.00	\$0.00
TANDEM SWITCHING	TELRIC COST STUDY		
		\$0.002085	N/A
TRANSPORT	TELRIC COST STUDY		
DS1		Rate Varies	\$222.95
DS3		Rate Varies	\$249.16
Common		\$0.000711	N/A
RECIPROCAL COMPENSATION	TELRIC COST STUDY		
End Office		\$0.003671	
Tandem Switching		\$0.002085	
Transport			
DS1		Rate Varies	\$222.95
DS3		Rate Varies	\$249.16
Common		\$0.000711	N/A
INTERCONNECTION	TELRIC COST STUDY		
CROSS CONNECTION			
DS0 Elec X-Conn		\$0.94	
DS1 Elec X-Conn		\$2.93	
DS3 Elec X-Conn		\$25.85	
Virtual DS0 Elec X-Conn		\$1.30	
DS1 Elec X-Conn		\$4.45	
DS3 Elec X-Conn		\$53.55	
COMMON CHANNEL SIGNALING INTERCONNECTION SERVICE			
STP Port		\$422.40	\$308.00
STP Switching		\$0.76	N/A
STP Transport Link 56.0 Kpbs SS7 Link per month		\$82.00	N/A
STP Transport Link 56.0 Kpbs SS7 Link per mile		\$4.80	N/A
STP Transport Link 1.544 Mbps SS7 Link per month		\$97.50	N/A
STP Transport Link 1.544 Mbps SS7 Link per mile		\$20.00	N/A
Multiplexing DS1 to DS0		\$300.00	\$142.00
Originating Point Code (OPC)			\$22.30
GlobalTitle Address Translation (GTT)			\$11.15
LINE INFORMATION DATABASE			
LIDB Administration Service (effective 5/11/98, no longer offering)	TELRIC COST STUDY	N/A	
LIDB Database Transport per query	Interstate Access Tariff	\$0.0016	
LIDB Database per query	Interstate Access Tariff	\$0.0366	

NETWORK ELEMENT PRICE LIST - SPRINT FLORIDA

RATE ELEMENT	SOURCE	RECURRING RATE	NRC
	TELRIC COST STUDY		
Toll Free Code Access Service query	Interstate Access Tariff	\$0.008822	
Toll Free Code Optional Service query	Interstate Access Tariff	\$0.001405	
DIRECTORY ASSISTANCE SERVICES			
DA Database Listing & Update	TELRIC COST STUDY	\$0.05	
DA Data Base Query Service	TELRIC COST STUDY	\$0.0100	
TOLL & LOCAL OPERATOR SERVICES	TELRIC COST STUDY		
Toll and Local Assistance Service (Live)		\$0.414	
DA OPERATOR SERVICE	TELRIC COST STUDY		
DA Operator Service (Live)		\$0.353	
STANDEM PORT	TELRIC COST STUDY		
Per DSO Equivalent Port		\$15.81	\$187.50
OPERATIONAL SUPPORT SYSTEMS			
OSS Interfaces*		ICB	
* Sprint is working on OSS and rates will be added as they are developed.			

LOCAL LOOPS - SPRINT FLORIDA

EXCHANGE	CLLI CODE	BAND	2 Wire Voice Grade Rate
Tallahassee XAH	TLHSFLXAH	BAND 1	\$15.00
Altamonte Springs	ALSPFLXAH	BAND 2	\$15.00
Apopka	APPKFLXAH	BAND 2	\$15.00
Casselberry	CSLBFLXAH	BAND 2	\$15.00
Ft Myers XAH	FTMYFLXAH	BAND 2	\$15.00
Ft Myers XCH	FTMYFLXCH	BAND 2	\$15.00
Ft Walton Beach XAH	FTWBFLXAH	BAND 2	\$15.00
Ft Walton Beach XBS	FTWBFLXBS	BAND 2	\$15.00
Goldenrod	GLRDFLXAH	BAND 2	\$15.00
Hurlburt AFB AJR	HRFDLAJR	BAND 2	\$15.00
Lake Brantley	LKBRFLXAH	BAND 2	\$15.00
Maitland LPR	MTLDFLLPR	BAND 2	\$15.00
Maitland XAS	MTLDFLXAS	BAND 2	\$15.00
Naples XBR	NPLSFLXBR	BAND 2	\$15.00
Naples XDH	NPLSFLXDH	BAND 2	\$15.00
Ocala XAH	OCALFLXAH	BAND 2	\$15.00
Ocala XCR	OCALFLXCR	BAND 2	\$15.00
Shalimar	SHLMFLXAS	BAND 2	\$15.00
Tallahassee XBS	TLHSFLXBS	BAND 2	\$15.00
Tallahassee XCS	TLHSFLXCS	BAND 2	\$15.00
Tavares	TVRSFLXAH	BAND 2	\$15.00
Windermere	WNRDFLXAR	BAND 2	\$15.00
Winter Park	WMPKFLXAH	BAND 2	\$15.00
Avon Park	AVPKFLXAH	BAND 3	\$15.00
Bellevue XAH	BLVWFLXAH	BAND 3	\$15.00
Beverly Hills	BVHLFLXAH	BAND 3	\$15.00
Boca Grande	BCGRFLXAR	BAND 3	\$15.00
Bonita Springs	BNSPFLXAS	BAND 3	\$15.00
Cape Coral XAH	CPCRFLEXAH	BAND 3	\$15.00
Cape Coral XBH	CPCRFLEXBH	BAND 3	\$15.00
Clermont	CLMTFLXAH	BAND 3	\$15.00
Clewiston	CLTNFLXAR	BAND 3	\$15.00
Crestview	CRVWFLXAS	BAND 3	\$15.00
Cypress Lake XAH	CYLKFLXAH	BAND 3	\$15.00
Dade City	DDCYFLXAH	BAND 3	\$15.00
Destin	DESTFLXAH	BAND 3	\$15.00
Eglin AFB	ELFDFLXAS	BAND 3	\$15.00
Eustis	ESTSFLXAH	BAND 3	\$15.00
Ft Meade	FTMDFLXAR	BAND 3	\$15.00
Ft Myers Beach	FTMBFLXAH	BAND 3	\$15.00
Ft Myers XBH	FTMYFLXBH	BAND 3	\$15.00
Ft Walton Beach XCR	FTWBFLXCR	BAND 3	\$15.00
Golden Gate	GLGCFLXAH	BAND 3	\$15.00
Homosassa Springs	HMSPFLEXAR	BAND 3	\$15.00
Inverness	INVRFLXAH	BAND 3	\$15.00
Iona	IONAFLXAR	BAND 3	\$15.00
Kissimmee XAH	KSSMFLXAH	BAND 3	\$15.00
Kissimmee XBH/West Kissi	KSSMFLXBH	BAND 3	\$15.00
Kissimmee XDR	KSSMFLXDR	BAND 3	\$15.00
Lady Lake	LDLKFLXAH	BAND 3	\$15.00
Leesburg	LSBGFLXAH	BAND 3	\$15.00
Lehigh Acres	LHACFLXAS	BAND 3	\$15.00

LOCAL LOOPS - SPRINT FLORIDA

EXCHANGE	CLLI CODE	BAND	2 Wire Voice Grade Rate
Marco Island	MOISFLXAH	BAND 3	\$15.00
Marianna	MRNNFLXAH	BAND 3	\$15.00
Mt Dora	MTDRFLXAH	BAND 3	\$15.00
Murdock	MRDCFLXAR	BAND 3	\$15.00
Naples BKS	NPLSFLBKS	BAND 3	\$15.00
Naples XCH	NPLSFLXCH	BAND 3	\$15.00
North Ft Myers XAH	NFMYFLXAH	BAND 3	\$15.00
North Naples	NNPLFLXAH	BAND 3	\$15.00
Ocala XBH	OCALFLXBH	BAND 3	\$15.00
Ocala XJR	OCALFLXJR	BAND 3	\$15.00
Orange City XAH	ORCYFLXAH	BAND 3	\$15.00
Orange City XCR	ORCYFLXCR	BAND 3	\$15.00
Port Charlotte	PTCTFLXAH	BAND 3	\$15.00
Punta Gorda XAS	PNGRFLXAS	BAND 3	\$15.00
San Carlos Park	SCPKFLXAR	BAND 3	\$15.00
Sanibel Island	SNISFLXAH	BAND 3	\$15.00
Sebring	SBNGFLXAH	BAND 3	\$15.00
Silver Springs	SVSPFLXAR	BAND 3	\$15.00
Silver Springs Shores	SVSSFLXAR	BAND 3	\$15.00
Tallahassee XDS	TLHSFLXDS	BAND 3	\$15.00
Tallahassee XFS	TLHSFLXFS	BAND 3	\$15.00
Tallahassee XHS	TLHSFLXHS	BAND 3	\$15.00
Valpraiso	VLPRFLXAH	BAND 3	\$15.00
Winter Garden	WNGRFLXAH	BAND 3	\$15.00
Alford	ALFRFLXAR	BAND 4	\$15.00
Alva	ALVAFLXAR	BAND 4	\$15.00
Arcadia	ARCDFLXAS	BAND 4	\$15.00
Astor	ASTRFLXAR	BAND 4	\$15.00
Baker	BAKRFLXAS	BAND 4	\$15.00
Belleview XDR	BLVWFLXDR	BAND 4	\$15.00
Bonifay	BNFYFLXAR	BAND 4	\$15.00
Bowling Green	BWLGFLXAR	BAND 4	\$15.00
Bushnell	BSHNFLXAH	BAND 4	\$15.00
Cape Haze	CPHZFLXAH	BAND 4	\$15.00
Chassahowitzka	CHSWFLXAR	BAND 4	\$15.00
Cherry Lake	CHLKFLXAR	BAND 4	\$15.00
Cottondale	CTDLFLXAR	BAND 4	\$15.00
Crawfordville	CFVLFLXAH	BAND 4	\$15.00
Crystal River	CRRVFLXAH	BAND 4	\$15.00
Cypress Lake XBR	CYLKFLXBR	BAND 4	\$15.00
Defuniak Springs	DFSPFLXAH	BAND 4	\$15.00
Everglades	EVRGFLXAR	BAND 4	\$15.00
Freeport	FRPTFLXAR	BAND 4	\$15.00
Glendale	GLDLFLXAR	BAND 4	\$15.00
Grand Ridge	GDRGFLXAS	BAND 4	\$15.00
Greenville	GNVLFLXAR	BAND 4	\$15.00
Greenwood	GNWDFLXAR	BAND 4	\$15.00
Groveland	GVLDFLXAR	BAND 4	\$15.00
Howey-in-the-Hills	HOWYFLXAR	BAND 4	\$15.00
Hurlburt AFB XAH	HRFDLXAH	BAND 4	\$15.00
Immokalee	IMKLFLXAR	BAND 4	\$15.00
Kenansville	KNVLFLXAR	BAND 4	\$15.00
Kingsley Lake	KGLKFLXAR	BAND 4	\$15.00

LOCAL LOOPS - SPRINT FLORIDA

EXCHANGE	CLLI CODE	BAND	2 Wire Voice Grade Rate
La Belle	LBLLFLXAH	BAND 4	\$15.00
Lake Helen	LKHLFLXAR	BAND 4	\$15.00
Lake Placid	LKPCFLXAR	BAND 4	\$15.00
Lawtey	LWTYFLXAR	BAND 4	\$15.00
Lee	LEE FLXAR	BAND 4	\$15.00
Madison	MDSNFLXAH	BAND 4	\$15.00
Malone	MALNFLXAR	BAND 4	\$15.00
Monteverde	MTVRFLXAR	BAND 4	\$15.00
Monticello	MNTIFLXAS	BAND 4	\$15.00
Moore Haven XAR	MRHNFLXAR	BAND 4	\$15.00
North Ft Myers XBH	NFMYFLXBH	BAND 4	\$15.00
Ocala National Forest	OCNFFLXAH	BAND 4	\$15.00
Okeechobee	OKCBFLXAH	BAND 4	\$15.00
Oklawaha	OKLWFLXAS	BAND 4	\$15.00
Panacea	PANCFLXAR	BAND 4	\$15.00
Pine Island	PNISFLXAH	BAND 4	\$15.00
Ponce de Leon	PNLNFLXAR	BAND 4	\$15.00
Punta Gorda BAS	PNGRFLBAS	BAND 4	\$15.00
Reynolds Hills	RYHLFLXAR	BAND 4	\$15.00
Salt Springs	SSPRFLXAR	BAND 4	\$15.00
San Antontio	SNANFLXAR	BAND 4	\$15.00
Santa Rosa	SNRSFLXAR	BAND 4	\$15.00
Sea Grove Beach	SGBHFLXAR	BAND 4	\$15.00
Sneads	SNDSFLXAR	BAND 4	\$15.00
Sopchoppy	SPCPFLXAS	BAND 4	\$15.00
Spring Lake Hills	SLHLFLXAR	BAND 4	\$15.00
St Cloud	STCDFLXAH	BAND 4	\$15.00
St Marks	STMKFLXAR	BAND 4	\$15.00
Starke	STRKFLXAH	BAND 4	\$15.00
Tallahassee XGS	TLHSFLXGS	BAND 4	\$15.00
Trillacoochee	TLCHFLXAR	BAND 4	\$15.00
Umatilla	UMTLFLXAR	BAND 4	\$15.00
Wauchula	WCHLFLXAH	BAND 4	\$15.00
Westville	WSTVFLXAR	BAND 4	\$15.00
Wildwood	WLWDFLXAR	BAND 4	\$15.00
Williston	WLSTFLXAR	BAND 4	\$15.00
Zolfo Springs	ZLSPFLXAR	BAND 4	\$15.00

LOCAL SWITCHING - SPRINT FLORIDA

EXCHANGE	BAND	RATE
ALTAMONTE SPRINGS, FL	1	\$7.00
BONITA SPRINGS, FL	1	\$7.00
CYPRESS LAKE, FL	1	\$7.00
FT MYERS BEACH, FL	1	\$7.00
FT. MYERS, FL	1	\$7.00
FT. WALTON BEACH, FL	1	\$7.00
GOLDENROD, FL	1	\$7.00
LAKE BRANTLEY, FL	1	\$7.00
TALLAHASSEE, FL	1	\$7.00
WINTER PARK, FL	1	\$7.00
APOPKA, FL	2	\$7.00
CASSELBERRY, FL	2	\$7.00
CHERRY LAKE, FL	2	\$7.00
EUSTIS, FL	2	\$7.00
FREEPORT, FL	2	\$7.00
KISSIMMEE, FL	2	\$7.00
LEESBURG, FL	2	\$7.00
NAPLES MOORINGS, FL	2	\$7.00
NAPLES, FL	2	\$7.00
OCALA, FL	2	\$7.00
ORANGE CITY, FL	2	\$7.00
PORT CHARLOTTE, FL	2	\$7.00
TAVARES, FL	2	\$7.00
VALPRAISO, FL	2	\$7.00
WILDWOOD, FL	2	\$7.00
ALFORD, FL	3	\$7.00
ARCADIA, FL	3	\$7.00
ASTOR, FL	3	\$7.00
AVON PARK, FL	3	\$7.00
BAKER, FL	3	\$7.00
BELLEVIEW, FL	3	\$7.00
BEVERLY HILLS, FL	3	\$7.00
BONIFAY, FL	3	\$7.00
BOWLING GREEN, FL	3	\$7.00
COTTONDALE, FL	3	\$7.00
CRESTVIEW, FL	3	\$7.00
CRYSTAL RIVER, FL	3	\$7.00
DADE CITY, FL	3	\$7.00
DESTIN, FL	3	\$7.00
EVERGLADES, FL	3	\$7.00
FOREST, FL	3	\$7.00
GLENDALE, FL	3	\$7.00
GREENVILLE, FL	3	\$7.00
GREENWOOD, FL	3	\$7.00
HOMOSASSA SPRINGS, FL	3	\$7.00
HOWEY-IN-THE-HILLS, FL	3	\$7.00
IMMOKALEE, FL	3	\$7.00

LOCAL SWITCHING - SPRINT FLORIDA

EXCHANGE	BAND	RATE
INVERNESS, FL	3	\$7.00
KENANSVILLE, FL	3	\$7.00
KINGSLEY LAKE, FL	3	\$7.00
LABELLE, FL	3	\$7.00
LADY LAKE, FL	3	\$7.00
LAWTEY, FL	3	\$7.00
LEE, FL	3	\$7.00
LEHIGH ACRES, FL	3	\$7.00
MADISON, FL	3	\$7.00
MAITLAND, FL	3	\$7.00
MALONE, FL	3	\$7.00
MARCO ISLAND, FL	3	\$7.00
MONTICELLO , FL	3	\$7.00
MONTVERDE, FL	3	\$7.00
MT. DORA, FL	3	\$7.00
NORTH NAPLES, FL	3	\$7.00
OKEECHOBEE, FL	3	\$7.00
OKLAWAHA, FL	3	\$7.00
PANACEA, FL	3	\$7.00
PONCE DE LEON, FL	3	\$7.00
REYNOLDS HILL, FL	3	\$7.00
SALT SPRINGS, FL	3	\$7.00
SANTA ROSA, FL	3	\$7.00
SEA GROVE BEACH, FL	3	\$7.00
SHADY ROAD, FL	3	\$7.00
SILVER SPRINGS SHORES, FL	3	\$7.00
SNEADS, FL	3	\$7.00
SOPCHOPPY, FL	3	\$7.00
ST. CLOUD, FL	3	\$7.00
ST. MARKS, FL	3	\$7.00
STARKE, FL	3	\$7.00
UMATILLA, FL	3	\$7.00
WEST KISSIMMEE, FL	3	\$7.00
WESTVILLE, FL	3	\$7.00
WILLISTON, FL	3	\$7.00
WINTER GARDEN, FL	3	\$7.00
BOCA GRANDE, FL	4	\$7.00
CAPE CORAL, FL	4	\$7.00
CLERMONT, FL	4	\$7.00
CLEWISTON, FL	4	\$7.00
CRAWFORDVILLE, FL	4	\$7.00
DEFUNIAK SPRINGS, FL	4	\$7.00
FORT MEADE, FL	4	\$7.00
MOORE HAVEN, FL	4	\$7.00
NORTH CAPE CORAL, FL	4	\$7.00
NORTH FT. MYERS, FL	4	\$7.00
PINE ISLAND, FL	4	\$7.00
REEDY CREEK, FL	4	\$7.00

LOCAL SWITCHING - SPRINT FLORIDA

EXCHANGE	BAND	RATE
WAUCHULA, FL	4	\$7.00
WINDERMERE, FL	4	\$7.00
ZOLFO SPRINGS, FL	4	\$7.00
BUSHNELL, FL	5	\$7.00
CAPE HAZE, FL	5	\$7.00
GROVELAND, FL	5	\$7.00
LAKE PLACID, FL	5	\$7.00
MARIANNA, FL	5	\$7.00
PUNTA GORDA, FL	5	\$7.00
SAN ANTONIO, FL	5	\$7.00
SANIBEL ISLAND, FL	5	\$7.00
SEBRING, FL	5	\$7.00
SHALIMAR, FL	5	\$7.00
SPRING LAKE, FL	5	\$7.00
TRILLACOOCHEE, FL	5	\$7.00

Reciprocal Compensation - End Office
SPRINT - FLORIDA

EXCHANGE	RATE
ALFORD, FL	\$0.003587
APOPKA, FL	\$0.003587
ARCADIA, FL	\$0.003587
ASTOR, FL	\$0.003587
AVON PARK, FL	\$0.003587
BAKER, FL	\$0.003587
BELLEVIEW, FL	\$0.003587
BEVERLY HILLS, FL	\$0.003587
BOCA GRANDE, FL	\$0.003587
BONIFAY, FL	\$0.003587
BONITA SPRINGS, FL	\$0.003587
BOWLING GREEN, FL	\$0.003587
BUSHNELL, FL	\$0.003587
CAPE CORAL, FL	\$0.003587
CAPE HAZE, FL	\$0.003587
CASSELBERRY, FL	\$0.003587
CHERRY LAKE, FL	\$0.003587
CLERMONT, FL	\$0.003587
CLEWISTON, FL	\$0.003587
COTTONDALE, FL	\$0.003587
CRAWFORDVILLE, FL	\$0.003587
CRESTVIEW, FL	\$0.003587
CRYSTAL RIVER, FL	\$0.003587
CYPRESS LAKE, FL	\$0.003587
DADE CITY, FL	\$0.003587
DEFUNIAK SPRINGS, FL	\$0.003587
DESTIN, FL	\$0.003587
EUSTIS, FL	\$0.003587
EVERGLADES, FL	\$0.003587
FOREST, FL	\$0.003587
FORT MEADE, FL	\$0.003587
FREEPORT, FL	\$0.003587
FT MYERS BEACH, FL	\$0.003587
FT. MYERS, FL	\$0.003587
FT. WALTON BEACH, FL	\$0.003587
GLENDALE, FL	\$0.003587
GOLDENROD, FL	\$0.003587
GREENVILLE, FL	\$0.003587
GREENWOOD, FL	\$0.003587
GROVELAND, FL	\$0.003587
HOMOSASSA SPRINGS, FL	\$0.003587
HOWEY-IN-THE-HILLS, FL	\$0.003587
IMMOKALEE, FL	\$0.003587
INVERNESS, FL	\$0.003587
KENANSVILLE, FL	\$0.003587
KINGSLEY LAKE, FL	\$0.003587
KISSIMMEE, FL	\$0.003587
LABELLE, FL	\$0.003587
LADY LAKE, FL	\$0.003587
LAKE BRANTLEY, FL	\$0.003587

Reciprocal Compensation - End Office
SPRINT - FLORIDA

EXCHANGE	RATE
LAKE PLACID, FL	\$0.003587
LAWTEY, FL	\$0.003587
LEE, FL	\$0.003587
LEESBURG, FL	\$0.003587
LEHIGH ACRES, FL	\$0.003587
MADISON, FL	\$0.003587
MAITLAND, FL	\$0.003587
MALONE, FL	\$0.003587
MARCO ISLAND, FL	\$0.003587
MARIANNA, FL	\$0.003587
MONTICELLO , FL	\$0.003587
MONTVERDE, FL	\$0.003587
MOORE HAVEN, FL	\$0.003587
MT. DORA, FL	\$0.003587
NAPLES MOORINGS, FL	\$0.003587
NAPLES, FL	\$0.003587
NORTH CAPE CORAL, FL	\$0.003587
NORTH FT. MYERS, FL	\$0.003587
NORTH NAPLES, FL	\$0.003587
OCALA, FL	\$0.003587
OKEECHOBEE, FL	\$0.003587
OKLAWAHA, FL	\$0.003587
ORANGE CITY, FL	\$0.003587
PANACEA, FL	\$0.003587
PINE ISLAND, FL	\$0.003587
PONCE DE LEON, FL	\$0.003587
PORT CHARLOTTE, FL	\$0.003587
PUNTA GORDA, FL	\$0.003587
REEDY CREEK, FL	\$0.003587
REYNOLDS HILL, FL	\$0.003587
SALT SPRINGS, FL	\$0.003587
SAN ANTONIO, FL	\$0.003587
SANIBEL ISLAND, FL	\$0.003587
SANTA ROSA, FL	\$0.003587
SEA GROVE BEACH, FL	\$0.003587
SEBRING, FL	\$0.003587
SHADY ROAD, FL	\$0.003587
SHALIMAR, FL	\$0.003587
SILVER SPRINGS SHORES, FL	\$0.003587
SNEADS, FL	\$0.003587
SOPCHOPPY, FL	\$0.003587
SPRING LAKE, FL	\$0.003587
ST. CLOUD, FL	\$0.003587
ST. MARKS, FL	\$0.003587
STARKE, FL	\$0.003587
TALLAHASSEE, FL	\$0.003587
TAVARES, FL	\$0.003587
TRILLACOOCHEE, FL	\$0.003587
UMATILLA, FL	\$0.003587
VALPRAISO, FL	\$0.003587

Reciprocal Compensation - End Office
SPRINT - FLORIDA

<u>EXCHANGE</u>	<u>RATE</u>
WAUCHULA, FL	\$0.003587
WEST KISSIMMEE, FL	\$0.003587
WESTVILLE, FL	\$0.003587
WILDWOOD, FL	\$0.003587
WILLISTON, FL	\$0.003587
WINDERMERE, FL	\$0.003587
WINTER GARDEN, FL	\$0.003587
WINTER PARK, FL	\$0.003587
ZOLFO SPRINGS, FL	\$0.003587

SPRINT - FLORIDA
TRANSPORT

Originating	Terminating	Dedicated DS1	Dedicated DS3	Common
Alford	Cottondale	\$ 117.53	\$ 1,364.32	\$0.001022
Alford	Marianna	\$ 195.52	\$ 2,728.64	\$0.001022
Altamonte Springs	Apopka	\$ 94.27	\$ 1,364.32	\$0.001022
Altamonte Springs	Casselberry	\$ 117.53	\$ 1,364.32	\$0.001022
Altamonte Springs	Celebration*	\$ 191.86	\$ 4,092.96	\$0.001022
Altamonte Springs	East Orange*	\$ 143.06	\$ 2,728.64	\$0.001022
Altamonte Springs	Geneva*	\$ 143.06	\$ 2,728.64	\$0.001022
Altamonte Springs	Goldenrod	\$ 117.53	\$ 1,364.32	\$0.001022
Altamonte Springs	Lake Brantley	\$ 94.27	\$ 1,364.32	\$0.001022
Altamonte Springs	Lake Buena Vista*	\$ 191.86	\$ 4,092.96	\$0.001022
Altamonte Springs	Maitland	\$ 94.27	\$ 1,364.32	\$0.001022
Altamonte Springs	Montverde	\$ 313.33	\$ 7,042.64	\$0.001022
Altamonte Springs	Orlando*	\$ 143.06	\$ 2,728.64	\$0.001022
Altamonte Springs	Oviedo*	\$ 143.06	\$ 2,728.64	\$0.001022
Altamonte Springs	Reedy Creek	\$ 218.09	\$ 4,092.96	\$0.001022
Altamonte Springs	Sanford*	\$ 143.06	\$ 2,728.64	\$0.001022
Altamonte Springs	Windermere	\$ 218.09	\$ 4,092.96	\$0.001022
Altamonte Springs	Winter Garden	\$ 143.06	\$ 2,728.64	\$0.001022
Altamonte Springs	Winter Park	\$ 117.53	\$ 1,364.32	\$0.001022
Alva	Bonita Springs	\$ 193.53	\$ 3,496.42	\$0.001022
Alva	Cape Coral	\$ 269.03	\$ 5,713.25	\$0.001022
Alva	East Fort Meyers	\$ 193.53	\$ 3,496.42	\$0.001022
Alva	Fort Meyers Regional Airport	\$ 287.80	\$ 5,678.32	\$0.001022
Alva	Fort Myers	\$ 193.53	\$ 3,496.42	\$0.001022
Alva	Fort Myers Beach	\$ 94.27	\$ 1,364.32	\$0.001022
Alva	Lehigh Acres	\$ 193.53	\$ 3,496.42	\$0.001022
Alva	North Cape Coral	\$ 269.03	\$ 5,713.25	\$0.001022
Alva	North Fort Myers	\$ 269.03	\$ 5,713.25	\$0.001022
Alva	Pine Island	\$ 94.27	\$ 1,364.32	\$0.001022
Alva	Sanibel-Captiva Islands	\$ 94.27	\$ 1,364.32	\$0.001022
Alva	South Fort Meyers	\$ 193.53	\$ 3,496.42	\$0.001022
Apopka	Casselberry	\$ 169.29	\$ 2,728.64	\$0.001022
Apopka	Celebration*	\$ 143.06	\$ 2,728.64	\$0.001022
Apopka	East Orange*	\$ 143.06	\$ 2,728.64	\$0.001022
Apopka	Goldenrod	\$ 169.29	\$ 2,728.64	\$0.001022
Apopka	Lake Brantley	\$ 94.27	\$ 1,364.32	\$0.001022
Apopka	Lake Buena Vista*	\$ 143.06	\$ 2,728.64	\$0.001022
Apopka	Maitland	\$ 94.27	\$ 1,364.32	\$0.001022
Apopka	Montverde	\$ 287.80	\$ 5,678.32	\$0.001022
Apopka	Orlando*	\$ 143.06	\$ 2,728.64	\$0.001022
Apopka	Reedy Creek	\$ 169.29	\$ 2,728.64	\$0.001022
Apopka	Windermere	\$ 169.29	\$ 2,728.64	\$0.001022
Apopka	Winter Garden	\$ 94.27	\$ 1,364.32	\$0.001022
Apopka	Winter Park	\$ 94.27	\$ 1,364.32	\$0.001022
Astor	Clermont	\$ 271.52	\$ 5,678.32	\$0.001022
Astor	Eustis	\$ 271.52	\$ 5,678.32	\$0.001022
Astor	Groveland	\$ 425.51	ICB	\$0.001022
Astor	Howey	\$ 441.79	ICB	\$0.001022
Astor	Lady Lake	\$ 425.51	ICB	\$0.001022
Astor	Leesburg	\$ 271.52	\$ 5,678.32	\$0.001022

SPRINT - FLORIDA
TRANSPORT

Originating	Terminating	Dedicated DS1	Dedicated DS3	Common
Astor	Montverde	\$ 441.79	ICB	\$0.001022
Astor	Mount Dora	\$ 271.52	\$ 5,678.32	\$0.001022
Astor	Tavares	\$ 271.52	\$ 5,678.32	\$0.001022
Astor	Umatilla	\$ 193.53	\$ 4,314.00	\$0.001022
Baker	Crestview	\$ 170.27	\$ 4,314.00	\$0.001022
Bellevue	Citra*	\$ 363.80	\$ 6,992.84	\$0.001022
Bellevue	Dunnellon*	\$ 245.29	\$ 4,860.74	\$0.001022
Bellevue	Forest	\$ 323.28	\$ 7,042.64	\$0.001022
Bellevue	Highlands	\$ 169.29	\$ 2,728.64	\$0.001022
Bellevue	Lady Lake (821)	\$ 193.53	\$ 4,314.00	\$0.001022
Bellevue	McIntosh*	\$ 363.80	\$ 6,992.84	\$0.001022
Bellevue	Ocala	\$ 193.53	\$ 3,496.42	\$0.001022
Bellevue	Ocklawaha	\$ 94.27	\$ 1,364.32	\$0.001022
Bellevue	Orange Springs *	\$ 363.80	\$ 6,992.84	\$0.001022
Bellevue	Salt Springs	\$ 578.30	ICB	\$0.001022
Bellevue	Silver Springs Shores	\$ 94.27	\$ 1,364.32	\$0.001022
Beverly Hills	Chassahowitzka	\$ 363.30	\$ 6,495.90	\$0.001022
Beverly Hills	Crystal River	\$ 269.03	\$ 4,314.00	\$0.001022
Beverly Hills	Homosassa Springs	\$ 269.03	\$ 4,314.00	\$0.001022
Beverly Hills	Inverness	\$ 269.03	\$ 4,314.00	\$0.001022
Bonify	Reynolds Hill	\$ 94.27	\$ 2,181.90	\$0.001022
Bonify	Westville	\$ 170.27	\$ 4,314.00	\$0.001022
Bonita Springs	Cypress Lake	\$ 193.53	\$ 3,496.42	\$0.001022
Bonita Springs	East Fort Myers	\$ 193.53	\$ 3,496.42	\$0.001022
Bonita Springs	Fort Myers	\$ 193.53	\$ 3,496.42	\$0.001022
Bonita Springs	Fort Myers Beach	\$ 245.29	\$ 4,860.74	\$0.001022
Bonita Springs	Golden Gate	\$ 193.53	\$ 3,496.42	\$0.001022
Bonita Springs	Naples	\$ 193.53	\$ 3,496.42	\$0.001022
Bonita Springs	Naples Moorings	\$ 193.53	\$ 3,496.42	\$0.001022
Bonita Springs	Naples Southeast	\$ 193.53	\$ 3,496.42	\$0.001022
Bonita Springs	North Naples	\$ 193.53	\$ 3,496.42	\$0.001022
Bowling Green	Wauchula	\$ 117.53	\$ 1,364.32	\$0.001022
Bowling Green	Zolfo Springs	\$ 170.27	\$ 3,496.42	\$0.001022
Buenaventura Lakes	Kisimmee	\$ 94.27	\$ 2,181.90	\$0.001022
Bushnell	Wildwood	\$ 347.52	\$ 7,810.42	\$0.001022
Cape Coral	Cypress Lake	\$ 269.03	\$ 5,713.25	\$0.001022
Cape Coral	East Fort Myers	\$ 269.03	\$ 5,713.25	\$0.001022
Cape Coral	Fort Myers	\$ 269.03	\$ 5,713.25	\$0.001022
Cape Coral	Fort Myers Beach	\$ 308.03	\$ 7,077.57	\$0.001022
Cape Coral	North Cape Coral	\$ 269.03	\$ 5,713.25	\$0.001022
Cape Coral	North Fort Myers	\$ 269.03	\$ 5,713.25	\$0.001022
Cape Coral	Pine Island	\$ 308.03	\$ 7,077.57	\$0.001022
Cape Coral	Sanibel-Captiva Islands	\$ 308.03	\$ 7,077.57	\$0.001022
Casselberry	Celebration*	\$ 218.09	\$ 4,092.96	\$0.001022
Casselberry	East Orange*	\$ 169.29	\$ 2,728.64	\$0.001022
Casselberry	Geneva*	\$ 169.29	\$ 2,728.64	\$0.001022
Casselberry	Goldenrod	\$ 117.53	\$ 1,364.32	\$0.001022
Casselberry	Lake Brantley	\$ 169.29	\$ 2,728.64	\$0.001022
Casselberry	Lake Buena Vista*	\$ 218.09	\$ 4,092.96	\$0.001022
Casselberry	Maitland	\$ 169.29	\$ 2,728.64	\$0.001022

SPRINT - FLORIDA
TRANSPORT

Originating	Terminating	Dedicated DS1	Dedicated DS3	Common
Casselberry	Montverde	\$ 339.56	\$ 7,042.64	\$0.001022
Casselberry	Orlando*	\$ 169.29	\$ 2,728.64	\$0.001022
Casselberry	Oviedo*	\$ 169.29	\$ 2,728.64	\$0.001022
Casselberry	Reedy Creek	\$ 244.32	\$ 4,092.96	\$0.001022
Casselberry	Sanford*	\$ 169.29	\$ 2,728.64	\$0.001022
Casselberry	Windermere	\$ 244.32	\$ 4,092.96	\$0.001022
Casselberry	Winter Garden	\$ 169.29	\$ 2,728.64	\$0.001022
Casselberry	Winter Park	\$ 117.53	\$ 1,364.32	\$0.001022
Chassohowitza	Crystal River	\$ 363.30	\$ 6,495.90	\$0.001022
Chassohowitza	Homosassa	\$ 94.27	\$ 2,181.90	\$0.001022
Chassohowitza	Inverness	\$ 363.30	\$ 6,495.90	\$0.001022
Cherry Lake	Greenville	\$ 425.29	ICB	\$0.001022
Cherry Lake	Lee	\$ 349.29	ICB	\$0.001022
Cherry Lake	Madison	\$ 255.02	\$ 5,894.16	\$0.001022
Clermont	Celebration*	\$ 169.29	\$ 2,728.64	\$0.001022
Clermont	Eustis	\$ 117.53	\$ 1,364.32	\$0.001022
Clermont	Groveland	\$ 193.53	\$ 3,496.42	\$0.001022
Clermont	Howey	\$ 287.80	\$ 5,678.32	\$0.001022
Clermont	Lady Lake	\$ 347.52	\$ 7,810.42	\$0.001022
Clermont	Leesburg	\$ 117.53	\$ 1,364.32	\$0.001022
Clermont	Lk. Buena Vista*	\$ 169.29	\$ 2,728.64	\$0.001022
Clermont	Montverde	\$ 287.80	\$ 5,678.32	\$0.001022
Clermont	Mt. Dora	\$ 117.53	\$ 1,364.32	\$0.001022
Clermont	Orlando*	\$ 218.09	\$ 4,092.96	\$0.001022
Clermont	Reedy Creek	\$ 117.53	\$ 1,364.32	\$0.001022
Clermont	Tavares	\$ 117.53	\$ 1,364.32	\$0.001022
Clermont	Umatilla	\$ 271.52	\$ 5,678.32	\$0.001022
Clermont	Windermere	\$ 244.32	\$ 4,092.96	\$0.001022
Clermont	Winter Garden	\$ 117.53	\$ 1,364.32	\$0.001022
Cottdondale	Marianna	\$ 117.53	\$ 1,364.32	\$0.001022
Crawfordville	Alligator Point*	\$ 665.28	ICB	\$0.001022
Crawfordville	Carrabelle*	\$ 665.28	ICB	\$0.001022
Crawfordville	Panacea	\$ 170.27	\$ 4,314.00	\$0.001022
Crawfordville	Sopchoppy	\$ 353.78	\$ 7,293.41	\$0.001022
Crawfordville	St. Marks	\$ 170.27	\$ 4,314.00	\$0.001022
Crawfordville	Tallahassee	\$ 353.78	\$ 7,293.41	\$0.001022
Crestview	Laurel Hill*	\$ 94.27	\$ 1,364.32	\$0.001022
Crystal River	Homosassa Springs	\$ 269.03	\$ 4,314.00	\$0.001022
Crystal River	Inverness	\$ 269.03	\$ 4,314.00	\$0.001022
Crystal River	Yankeetown*	\$ 308.03	\$ 5,678.32	\$0.001022
Cypress Lake	East Fort Meyers	\$ 193.53	\$ 3,496.42	\$0.001022
Cypress Lake	Fort Meyers Regional Airport	\$ 94.27	\$ 2,181.90	\$0.001022
Cypress Lake	Fort Myers	\$ 193.53	\$ 3,496.42	\$0.001022
Cypress Lake	Fort Myers Beach	\$ 94.27	\$ 1,364.32	\$0.001022
Cypress Lake	Lehigh Acres	\$ 193.53	\$ 3,496.42	\$0.001022
Cypress Lake	North Cape Coral	\$ 269.03	\$ 5,713.25	\$0.001022
Cypress Lake	North Fort Myers	\$ 94.27	\$ 1,364.32	\$0.001022
Cypress Lake	Pine Island	\$ 94.27	\$ 1,364.32	\$0.001022
Cypress Lake	Sanibel-Captiva Islands	\$ 94.27	\$ 1,364.32	\$0.001022
Cypress Lake	South Fort Meyers	\$ 193.53	\$ 3,496.42	\$0.001022

SPRINT - FLORIDA
TRANSPORT

Originating	Terminating	Dedicated DS1	Dedicated DS3	Common
Dade City	San Antonio	\$ 117.53	\$ 1,364.32	\$0.001022
Dade City	Trilacoochee	\$ 117.53	\$ 1,364.32	\$0.001022
Dade City	Zephyrhills*	\$ 94.27	\$ 1,364.32	\$0.001022
DeFuniak Springs	Freeport	\$ 193.53	\$ 3,496.42	\$0.001022
DeFuniak Springs	Glendale	\$ 170.27	\$ 4,314.00	\$0.001022
DeFuniak Springs	Paxton*	\$ 245.29	\$ 4,860.74	\$0.001022
DeFuniak Springs	Ponce de Leon	\$ 170.27	\$ 4,314.00	\$0.001022
Deltona Lakes	Lake Helen	\$ 94.27	\$ 2,181.90	\$0.001022
Deltona Lakes	Orange City	\$ 94.27	\$ 2,181.90	\$0.001022
Destin	Fort Walton Beach	\$ 193.53	\$ 3,496.42	\$0.001022
Destin	Niceville	\$ 193.53	\$ 3,496.42	\$0.001022
Destin	Santa Rosa Beach	\$ 117.53	\$ 1,364.32	\$0.001022
Destin	Shalimar	\$ 193.53	\$ 3,496.42	\$0.001022
Destin	Valparaiso	\$ 193.53	\$ 3,496.42	\$0.001022
East Fort Myers	Fort Myers Regional Airport	\$ 287.80	\$ 5,678.32	\$0.001022
East Fort Myers	Fort Myers	\$ 193.53	\$ 3,496.42	\$0.001022
East Fort Myers	Fort Myers Beach	\$ 94.27	\$ 1,364.32	\$0.001022
East Fort Myers	Lehigh Acres	\$ 193.53	\$ 3,496.42	\$0.001022
East Fort Myers	North Cape Coral	\$ 269.03	\$ 5,713.25	\$0.001022
East Fort Myers	North Fort Myers	\$ 269.03	\$ 5,713.25	\$0.001022
East Fort Myers	Pine Island	\$ 94.27	\$ 1,364.32	\$0.001022
East Fort Myers	Sanibel-Captiva Islands	\$ 94.27	\$ 1,364.32	\$0.001022
East Fort Myers	South Fort Meyers	\$ 193.53	\$ 3,496.42	\$0.001022
Eustis	Groveland	\$ 271.52	\$ 4,860.74	\$0.001022
Eustis	Howey	\$ 287.80	\$ 5,678.32	\$0.001022
Eustis	Lady Lake	\$ 271.52	\$ 5,678.32	\$0.001022
Eustis	Leesburg	\$ 117.53	\$ 1,364.32	\$0.001022
Eustis	Montverde	\$ 287.80	\$ 5,678.32	\$0.001022
Eustis	Mt. Dora	\$ 117.53	\$ 1,364.32	\$0.001022
Eustis	Tavares	\$ 117.53	\$ 1,364.32	\$0.001022
Eustis	Umatilla	\$ 117.53	\$ 1,364.32	\$0.001022
Forest	Citra*	\$ 441.79	ICB	\$0.001022
Forest	Dunnellon*	\$ 477.27	ICB	\$0.001022
Forest	Highlands	\$ 193.53	\$ 4,314.00	\$0.001022
Forest	Lady Lake (821)	\$ 474.31	ICB	\$0.001022
Forest	McIntosh	\$ 441.79	ICB	\$0.001022
Forest	Ocala	\$ 271.52	\$ 5,678.32	\$0.001022
Forest	Ocklawaha	\$ 323.28	\$ 7,042.64	\$0.001022
Forest	Orange Springs*	\$ 441.79	ICB	\$0.001022
Forest	Salt Springs	\$ 448.55	ICB	\$0.001022
Forest	Silver Springs Shores	\$ 323.28	\$ 7,042.64	\$0.001022
Fort Meade	Bartow*	\$ 94.27	\$ 1,364.32	\$0.001022
Fort Meade	Lakeland*	\$ 94.27	\$ 1,364.32	\$0.001022
Fort Meyers Regional Airport	South Fort Meyers	\$ 287.80	\$ 5,678.32	\$0.001022
Fort Myers	Fort Myers Beach	\$ 94.27	\$ 1,364.32	\$0.001022
Fort Myers	Lehigh Acres	\$ 193.53	\$ 3,496.42	\$0.001022
Fort Myers	North Cape Coral	\$ 269.03	\$ 5,713.25	\$0.001022
Fort Myers	North Fort Myers	\$ 269.03	\$ 5,713.25	\$0.001022
Fort Myers	Pine Island	\$ 94.27	\$ 1,364.32	\$0.001022
Fort Myers	Sanibel-Captiva Islands	\$ 94.27	\$ 1,364.32	\$0.001022

SPRINT - FLORIDA
TRANSPORT

Originating	Terminating	Dedicated DS1	Dedicated DS3	Common
Fort Myers Beach	Lehigh Acres	\$ 245.29	\$ 4,860.74	\$0.001022
Fort Myers Beach	North Cape Coral	\$ 308.03	\$ 7,077.57	\$0.001022
Fort Myers Beach	North Fort Myers	\$ 94.27	\$ 1,364.32	\$0.001022
Fort Myers Beach	Pine Island	\$ 94.27	\$ 1,364.32	\$0.001022
Fort Myers Beach	Sanibel-Captiva Islands	\$ 94.27	\$ 1,364.32	\$0.001022
Fort Walton Beach	Holley-Navarre*	\$ 94.27	\$ 1,364.32	\$0.001022
Fort Walton Beach	Niceville	\$ 193.53	\$ 3,496.42	\$0.001022
Fort Walton Beach	Santa Rosa Beach	\$ 271.52	\$ 4,860.74	\$0.001022
Fort Walton Beach	Shalimar	\$ 193.53	\$ 3,496.42	\$0.001022
Fort Walton Beach	Valparaiso	\$ 193.53	\$ 3,496.42	\$0.001022
Golden Gate	Marco Island	\$ 193.53	\$ 3,496.42	\$0.001022
Golden Gate	Naples	\$ 193.53	\$ 3,496.42	\$0.001022
Golden Gate	Naples Moorings	\$ 193.53	\$ 3,496.42	\$0.001022
Golden Gate	Naples Southeast	\$ 193.53	\$ 3,496.42	\$0.001022
Golden Gate	North Naples	\$ 193.53	\$ 3,496.42	\$0.001022
Goldenrod	Celebration*	\$ 218.09	\$ 4,092.96	\$0.001022
Goldenrod	East Orange*	\$ 169.29	\$ 2,728.64	\$0.001022
Goldenrod	Geneva*	\$ 169.29	\$ 2,728.64	\$0.001022
Goldenrod	Lake Brantley	\$ 169.29	\$ 2,728.64	\$0.001022
Goldenrod	Lake Buena Vista*	\$ 218.09	\$ 4,092.96	\$0.001022
Goldenrod	Maitland	\$ 169.29	\$ 2,728.64	\$0.001022
Goldenrod	Montverde	\$ 339.56	\$ 7,042.64	\$0.001022
Goldenrod	Orlando*	\$ 169.29	\$ 2,728.64	\$0.001022
Goldenrod	Oviedo*	\$ 169.29	\$ 2,728.64	\$0.001022
Goldenrod	Reedy Creek	\$ 244.32	\$ 4,092.96	\$0.001022
Goldenrod	Sanford*	\$ 169.29	\$ 2,728.64	\$0.001022
Goldenrod	Windermere	\$ 244.32	\$ 4,092.96	\$0.001022
Goldenrod	Winter Garden	\$ 169.29	\$ 2,728.64	\$0.001022
Goldenrod	Winter Park	\$ 117.53	\$ 1,364.32	\$0.001022
Grand Ridge	Marianna	\$ 117.53	\$ 1,364.32	\$0.001022
Grand Ridge	Sneads	\$ 117.53	\$ 1,364.32	\$0.001022
Greenville	Lee	\$ 264.54	\$ 6,495.90	\$0.001022
Greenville	Madison	\$ 170.27	\$ 4,314.00	\$0.001022
Greenville	Monticello	\$ 193.53	\$ 3,496.42	\$0.001022
Greenville	Tallahassee	\$ 193.53	\$ 3,496.42	\$0.001022
Greenwood	Malone	\$ 117.53	\$ 1,364.32	\$0.001022
Greenwood	Marianna	\$ 117.53	\$ 1,364.32	\$0.001022
Groveland	Howey-in-the-Hills	\$ 363.80	\$ 7,810.42	\$0.001022
Groveland	Lady Lake	\$ 347.52	\$ 7,810.42	\$0.001022
Groveland	Leesburg	\$ 193.53	\$ 3,496.42	\$0.001022
Groveland	Montverde	\$ 441.79	ICB	\$0.001022
Groveland	Mt. Dora	\$ 271.52	\$ 4,860.74	\$0.001022
Groveland	Tavares	\$ 271.52	\$ 4,860.74	\$0.001022
Groveland	Umatilla	\$ 425.51	ICB	\$0.001022
Highlands	Citra*	\$ 287.80	\$ 4,860.74	\$0.001022
Highlands	Dunnellon*	\$ 323.28	\$ 6,225.06	\$0.001022
Highlands	Lady Lake (821)	\$ 271.52	\$ 5,678.32	\$0.001022
Highlands	McIntosh*	\$ 287.80	\$ 4,860.74	\$0.001022
Highlands	Ocala	\$ 117.53	\$ 1,364.32	\$0.001022
Highlands	Ocklawaha	\$ 169.29	\$ 2,728.64	\$0.001022

SPRINT - FLORIDA
TRANSPORT

Originating	Terminating	Dedicated DS1	Dedicated DS3	Common
Highlands	Orange Springs*	\$ 287.80	\$ 4,860.74	\$0.001022
Highlands	Salt Springs	\$ 526.54	ICB	\$0.001022
Highlands	Shady Road	\$ 193.53	\$ 3,496.42	\$0.001022
Highlands	Silver Springs	\$ 94.27	\$ 2,181.90	\$0.001022
Highlands	Silver Springs Shores	\$ 169.29	\$ 2,728.64	\$0.001022
Homosassa Spgs	Inverness	\$ 269.03	\$ 4,314.00	\$0.001022
Howey-In-The-Hills	Lady Lake	\$ 363.80	ICB	\$0.001022
Howey-In-The-Hills	Leesburg	\$ 287.80	\$ 5,678.32	\$0.001022
Howey-In-The-Hills	Montverde	\$ 458.07	ICB	\$0.001022
Howey-In-The-Hills	Mt. Dora	\$ 287.80	\$ 5,678.32	\$0.001022
Howey-In-The-Hills	Tavares	\$ 287.80	\$ 5,678.32	\$0.001022
Howey-In-The-Hills	Umatilla	\$ 441.79	ICB	\$0.001022
Kenansville	Kissimmee	\$ 193.53	\$ 3,496.42	\$0.001022
Kenansville	St. Cloud	\$ 193.53	\$ 3,496.42	\$0.001022
Kenansville	West Kissimmee	\$ 245.29	\$ 4,860.74	\$0.001022
Kingsley Lake	Lawtey	\$ 255.02	\$ 5,894.16	\$0.001022
Kingsley Lake	Raiford*	\$ 349.29	\$ 7,258.48	\$0.001022
Kingsley Lake	Starke	\$ 255.02	\$ 5,894.16	\$0.001022
Kissimmee	Celebration*	\$ 143.06	\$ 2,728.64	\$0.001022
Kissimmee	Haines City * (427)	\$ 193.53	\$ 3,496.42	\$0.001022
Kissimmee	St. Cloud	\$ 193.53	\$ 3,496.42	\$0.001022
Kissimmee	West Kissimmee	\$ 94.27	\$ 1,364.32	\$0.001022
Lady Lake (753)	Leesburg	\$ 193.53	\$ 4,314.00	\$0.001022
Lady Lake (753)	Montverde	\$ 441.79	ICB	\$0.001022
Lady Lake (753)	Mt. Dora	\$ 271.52	\$ 5,678.32	\$0.001022
Lady Lake (753)	Tavares	\$ 271.52	\$ 5,678.32	\$0.001022
Lady Lake (753)	Umatilla	\$ 425.51	ICB	\$0.001022
Lady Lake (821)	Leesburg	\$ 193.53	\$ 4,314.00	\$0.001022
Lady Lake (821)	Montverde	\$ 441.79	ICB	\$0.001022
Lady Lake (821)	Mt. Dora	\$ 271.52	\$ 5,678.32	\$0.001022
Lady Lake (821)	Ocala	\$ 347.52	\$ 7,810.42	\$0.001022
Lady Lake (821)	Ocklawaha	\$ 245.29	\$ 5,678.32	\$0.001022
Lady Lake (821)	Salt Springs	\$ 729.33	ICB	\$0.001022
Lady Lake (821)	Silver Springs Shores	\$ 245.29	\$ 5,678.32	\$0.001022
Lady Lake (821)	Tavares	\$ 271.52	\$ 5,678.32	\$0.001022
Lady Lake (821)	Umatilla	\$ 425.51	ICB	\$0.001022
Lake Brantley	Celebration*	\$ 191.86	\$ 4,092.96	\$0.001022
Lake Brantley	East Orange*	\$ 143.06	\$ 2,728.64	\$0.001022
Lake Brantley	Geneva*	\$ 143.06	\$ 2,728.64	\$0.001022
Lake Brantley	Lake Buena Vista*	\$ 191.86	\$ 4,092.96	\$0.001022
Lake Brantley	Maitland	\$ 94.27	\$ 1,364.32	\$0.001022
Lake Brantley	Montverde	\$ 313.33	\$ 7,042.64	\$0.001022
Lake Brantley	Orlando*	\$ 143.06	\$ 2,728.64	\$0.001022
Lake Brantley	Oviedo*	\$ 143.06	\$ 2,728.64	\$0.001022
Lake Brantley	Reedy Creek	\$ 218.09	\$ 4,092.96	\$0.001022
Lake Brantley	Sanford*	\$ 143.06	\$ 2,728.64	\$0.001022
Lake Brantley	Windermere	\$ 218.09	\$ 4,092.96	\$0.001022
Lake Brantley	Winter Garden	\$ 143.06	\$ 2,728.64	\$0.001022
Lake Brantley	Winter Park	\$ 94.27	\$ 1,364.32	\$0.001022
Lake Helen	Orange City	\$ 94.27	\$ 2,181.90	\$0.001022

SPRINT - FLORIDA
TRANSPORT

Originating	Terminating	Dedicated DS1	Dedicated DS3	Common
Lawtey	Raiford*	\$ 349.29	\$ 7,258.48	\$0.001022
Lawtey	Starke	\$ 255.02	\$ 5,894.16	\$0.001022
Lee	Madison	\$ 94.27	\$ 2,181.90	\$0.001022
Leesburg	Montverde	\$ 287.80	\$ 5,678.32	\$0.001022
Leesburg	Mt. Dora	\$ 117.53	\$ 1,364.32	\$0.001022
Leesburg	Tavares	\$ 117.53	\$ 1,364.32	\$0.001022
Leesburg	Umatilla	\$ 271.52	\$ 5,678.32	\$0.001022
Maitland	Celebration*	\$ 191.86	\$ 4,092.96	\$0.001022
Maitland	East Orange*	\$ 143.06	\$ 2,728.64	\$0.001022
Maitland	Geneva*	\$ 143.06	\$ 2,728.64	\$0.001022
Maitland	Lake Buena Vista*	\$ 191.86	\$ 4,092.96	\$0.001022
Maitland	Montverde	\$ 313.33	\$ 7,042.64	\$0.001022
Maitland	Orlando*	\$ 143.06	\$ 2,728.64	\$0.001022
Maitland	Oviedo*	\$ 143.06	\$ 2,728.64	\$0.001022
Maitland	Reedy Creek	\$ 218.09	\$ 4,092.96	\$0.001022
Maitland	Sanford*	\$ 143.06	\$ 2,728.64	\$0.001022
Maitland	Windermere	\$ 218.09	\$ 4,092.96	\$0.001022
Maitland	Winter Garden	\$ 143.06	\$ 2,728.64	\$0.001022
Maitland	Winter Park	\$ 94.27	\$ 1,364.32	\$0.001022
Malone	Marianna	\$ 117.53	\$ 1,364.32	\$0.001022
Marco Island	Naples	\$ 193.53	\$ 3,496.42	\$0.001022
Marco Island	Naples Moorings	\$ 193.53	\$ 3,496.42	\$0.001022
Marco Island	Naples Southeast	\$ 193.53	\$ 3,496.42	\$0.001022
Marco Island	North Naples	\$ 193.53	\$ 3,496.42	\$0.001022
Marianna	Altha *	\$ 94.27	\$ 1,364.32	\$0.001022
Marianna	Sneads	\$ 117.53	\$ 1,364.32	\$0.001022
Monticello	Tallahassee	\$ 193.53	\$ 3,496.42	\$0.001022
Montverde	Celebration*	\$ 339.56	\$ 7,042.64	\$0.001022
Montverde	East Orange*	\$ 313.33	\$ 7,042.64	\$0.001022
Montverde	Lk. Buena Vista	\$ 339.56	\$ 7,042.64	\$0.001022
Montverde	Mt. Dora	\$ 287.80	\$ 5,678.32	\$0.001022
Montverde	Orlando*	\$ 313.33	\$ 7,042.64	\$0.001022
Montverde	Reedy Creek	\$ 287.80	\$ 5,678.32	\$0.001022
Montverde	Tavares	\$ 287.80	\$ 5,678.32	\$0.001022
Montverde	Umatilla	\$ 287.80	\$ 5,678.32	\$0.001022
Montverde	Windermere	\$ 287.80	\$ 5,678.32	\$0.001022
Montverde	Winter Garden	\$ 170.27	\$ 4,314.00	\$0.001022
Montverde	Winter Park	\$ 264.54	\$ 5,678.32	\$0.001022
Mt. Dora	Tavares	\$ 117.53	\$ 1,364.32	\$0.001022
Mt. Dora	Umatilla	\$ 271.52	\$ 5,678.32	\$0.001022
Naples	Naples South East	\$ 193.53	\$ 3,496.42	\$0.001022
Naples	North Naples	\$ 193.53	\$ 3,496.42	\$0.001022
Naples Mooring	Naples South East	\$ 193.53	\$ 3,496.42	\$0.001022
Naples Mooring	North Naples	\$ 193.53	\$ 3,496.42	\$0.001022
Naples Southeast	North Naples	\$ 193.53	\$ 3,496.42	\$0.001022
Niceville	Shalimar	\$ 193.53	\$ 3,496.42	\$0.001022
North Cape Coral	North Fort Myers	\$ 269.03	\$ 5,713.25	\$0.001022
North Cape Coral	Pine Island	\$ 308.03	\$ 7,077.57	\$0.001022
North Cape Coral	Sanibel-Captiva Islands	\$ 308.03	\$ 7,077.57	\$0.001022
North Fort Myers	Pine Island	\$ 94.27	\$ 1,364.32	\$0.001022

SPRINT - FLORIDA
TRANSPORT

Originating	Terminating	Dedicated DS1	Dedicated DS3	Common
North Fort Myers	Sanibel-Captiva Islands	\$ 94.27	\$ 1,364.32	\$0.001022
Ocala	Citra*	\$ 363.80	\$ 6,992.84	\$0.001022
Ocala	Dunnellon*	\$ 245.29	\$ 4,860.74	\$0.001022
Ocala	McIntosh*	\$ 363.80	\$ 6,992.84	\$0.001022
Ocala	Ocklawaha	\$ 94.27	\$ 1,364.32	\$0.001022
Ocala	Orange Springs*	\$ 363.80	\$ 6,992.84	\$0.001022
Ocala	Salt Springs	\$ 526.54	ICB	\$0.001022
Ocala	Shady Road	\$ 193.53	\$ 3,496.42	\$0.001022
Ocala	Silver Springs	\$ 211.80	\$ 3,546.22	\$0.001022
Ocala	Silver Springs Shores	\$ 94.27	\$ 1,364.32	\$0.001022
Ocklawaha	Citra*	\$ 264.54	\$ 4,860.74	\$0.001022
Ocklawaha	Dunnellon*	\$ 297.05	\$ 6,225.06	\$0.001022
Ocklawaha	McIntosh*	\$ 264.54	\$ 4,860.74	\$0.001022
Ocklawaha	Orange Springs*	\$ 264.54	\$ 4,860.74	\$0.001022
Ocklawaha	Salt Springs	\$ 578.30	ICB	\$0.001022
Ocklawaha	Silver Springs Shores	\$ 94.27	\$ 1,364.32	\$0.001022
Orange City	DeBary*	\$ 94.27	\$ 1,364.32	\$0.001022
Orange City	Deland*	\$ 94.27	\$ 1,364.32	\$0.001022
Orange City	DeLeon Springs*	\$ 94.27	\$ 1,364.32	\$0.001022
Panacea	Alligator Point	\$ 835.55	ICB	\$0.001022
Panacea	Sopchoppy	\$ 524.05	ICB	\$0.001022
Panacea	St. Marks	\$ 340.54	ICB	\$0.001022
Panacea	Tallahassee	\$ 524.05	ICB	\$0.001022
Pine Island	Sanibel-Captiva Islands	\$ 94.27	\$ 1,364.32	\$0.001022
Reedy Creek	Celebration*	\$ 169.29	\$ 2,728.64	\$0.001022
Reedy Creek	East Orange*	\$ 218.09	\$ 4,092.96	\$0.001022
Reedy Creek	Lake Buena Vista*	\$ 169.29	\$ 2,728.64	\$0.001022
Reedy Creek	Orlando*	\$ 218.09	\$ 4,092.96	\$0.001022
Reedy Creek	West Kissimmee	\$ 117.53	\$ 1,364.32	\$0.001022
Reedy Creek	Windermere	\$ 195.52	\$ 2,728.64	\$0.001022
Reedy Creek	Winter Garden	\$ 117.53	\$ 1,364.32	\$0.001022
Reedy Creek	Winter Park	\$ 169.29	\$ 2,728.64	\$0.001022
Reynolds Hill	Westville	\$ 264.54	\$ 6,495.90	\$0.001022
Salt Springs	Citra*	\$ 696.81	ICB	\$0.001022
Salt Springs	Dunnellon	\$ 732.29	ICB	\$0.001022
Salt Springs	McIntosh*	\$ 696.81	ICB	\$0.001022
Salt Springs	Orange Springs*	\$ 696.81	ICB	\$0.001022
Salt Springs	Silver Springs Shores	\$ 578.30	ICB	\$0.001022
San Antonio	Trilacoochee	\$ 195.52	\$ 2,728.64	\$0.001022
San Antonio	Zephyrhills*	\$ 169.29	\$ 2,728.64	\$0.001022
Santa Rosa Beach	Seagrove Beach	\$ 117.53	\$ 1,364.32	\$0.001022
Sebring	Spring Lake	\$ 170.27	\$ 3,496.42	\$0.001022
Shalimar	Valparaiso	\$ 193.53	\$ 3,496.42	\$0.001022
Silver Springs Shores	Citra*	\$ 264.54	\$ 4,860.74	\$0.001022
Silver Springs Shores	Dunnellon*	\$ 297.05	\$ 6,225.06	\$0.001022
Silver Springs Shores	McIntosh*	\$ 264.54	\$ 4,860.74	\$0.001022
Silver Springs Shores	Orange Springs*	\$ 264.54	\$ 4,860.74	\$0.001022
Sopchoppy	Alligator Point*	\$ 665.28	ICB	\$0.001022
Sopchoppy	Carrabelle*	\$ 665.28	ICB	\$0.001022
Sopchoppy	St. Marks	\$ 524.05	ICB	\$0.001022

SPRINT - FLORIDA
TRANSPORT

Originating	Terminating	Dedicated DS1	Dedicated DS3	Common
Sopchoppy	Tallahassee	\$ 353.78	\$ 7,293.41	\$0.001022
St. Cloud	Celebration*	\$ 143.06	\$ 2,728.64	\$0.001022
St. Cloud	West Kissimee	\$ 94.27	\$ 1,364.32	\$0.001022
St. Marks	Alligator Point*	\$ 835.55	ICB	\$0.001022
St. Marks	Tallahassee	\$ 524.05	ICB	\$0.001022
Starke	Keystone Heights*	\$ 349.29	\$ 7,258.48	\$0.001022
Starke	Raiford*	\$ 349.29	\$ 7,258.48	\$0.001022
Tallahassee-Calhoun	Alligator Point*	\$ 363.80	\$ 6,992.84	\$0.001022
Tallahassee-Calhoun	Bristol*	\$ 169.29	\$ 2,728.64	\$0.001022
Tallahassee-Calhoun	Carrabelle*	\$ 363.80	\$ 6,992.84	\$0.001022
Tallahassee-Calhoun	Chattahoochee*	\$ 363.80	\$ 6,992.84	\$0.001022
Tallahassee-Calhoun	Greensboro*	\$ 169.29	\$ 2,728.64	\$0.001022
Tallahassee-Calhoun	Gretna*	\$ 169.29	\$ 2,728.64	\$0.001022
Tallahassee-Calhoun	Havana*	\$ 169.29	\$ 2,728.64	\$0.001022
Tallahassee-Calhoun	Hosford*	\$ 169.29	\$ 2,728.64	\$0.001022
Tallahassee-Calhoun	Quincy*	\$ 169.29	\$ 2,728.64	\$0.001022
Tallahassee-Calhoun	Tallahassee-FSU	\$ 117.53	\$ 1,364.32	\$0.001022
Tallahassee-Calhoun	Tallahassee-Mabry	\$ 117.53	\$ 1,364.32	\$0.001022
Tallahassee-Calhoun	Tallahassee-Perkins	\$ 117.53	\$ 1,364.32	\$0.001022
Tallahassee-Calhoun	Tallahassee-Willis	\$ 117.53	\$ 1,364.32	\$0.001022
Tallahassee-Calhoun	Tallahassee Thomasville	\$ 195.52	\$ 2,728.64	\$0.001022
Tallahassee-FSU	Alligator Point*	\$ 441.79	ICB	\$0.001022
Tallahassee-FSU	Bristol*	\$ 169.29	\$ 2,728.64	\$0.001022
Tallahassee-FSU	Carrabelle*	\$ 441.79	ICB	\$0.001022
Tallahassee-FSU	Chattahoochee*	\$ 441.79	ICB	\$0.001022
Tallahassee-FSU	Greensboro*	\$ 169.29	\$ 2,728.64	\$0.001022
Tallahassee-FSU	Gretna*	\$ 169.29	\$ 2,728.64	\$0.001022
Tallahassee-FSU	Havana*	\$ 169.29	\$ 2,728.64	\$0.001022
Tallahassee-FSU	Hosford*	\$ 169.29	\$ 2,728.64	\$0.001022
Tallahassee-FSU	Quincy*	\$ 169.29	\$ 2,728.64	\$0.001022
Tallahassee-FSU	Tallahassee-Mabry	\$ 117.53	\$ 1,364.32	\$0.001022
Tallahassee-FSU	Tallahassee-Perkins	\$ 117.53	\$ 1,364.32	\$0.001022
Tallahassee-FSU	Tallahassee-Willis	\$ 117.53	\$ 1,364.32	\$0.001022
Tallahassee-FSU	Tallahassee Thomasville	\$ 195.52	\$ 2,728.64	\$0.001022
Tallahassee-Mabry	Alligator Point*	\$ 441.79	ICB	\$0.001022
Tallahassee-Mabry	Bristol*	\$ 169.29	\$ 2,728.64	\$0.001022
Tallahassee-Mabry	Carrabelle*	\$ 441.79	ICB	\$0.001022
Tallahassee-Mabry	Chattahoochee*	\$ 441.79	ICB	\$0.001022
Tallahassee-Mabry	Greensboro*	\$ 169.29	\$ 2,728.64	\$0.001022
Tallahassee-Mabry	Gretna*	\$ 169.29	\$ 2,728.64	\$0.001022
Tallahassee-Mabry	Havana*	\$ 169.29	\$ 2,728.64	\$0.001022
Tallahassee-Mabry	Hosford*	\$ 169.29	\$ 2,728.64	\$0.001022
Tallahassee-Mabry	Quincy*	\$ 169.29	\$ 2,728.64	\$0.001022
Tallahassee-Mabry	Tallahassee-Perkins	\$ 117.53	\$ 1,364.32	\$0.001022
Tallahassee-Mabry	Tallahassee-Willis	\$ 117.53	\$ 1,364.32	\$0.001022
Tallahassee-Mabry	Tallahassee Thomasville	\$ 195.52	\$ 2,728.64	\$0.001022
Tallahassee-Perkins	Alligator Point*	\$ 441.79	ICB	\$0.001022
Tallahassee-Perkins	Bristol*	\$ 169.29	\$ 2,728.64	\$0.001022
Tallahassee-Perkins	Carrabelle*	\$ 441.79	ICB	\$0.001022
Tallahassee-Perkins	Chattahoochee*	\$ 441.79	ICB	\$0.001022

SPRINT - FLORIDA
TRANSPORT

Originating	Terminating	Dedicated DS1	Dedicated DS3	Common
Tallahassee-Perkins	Greensboro*	\$ 169.29	\$ 2,728.64	\$0.001022
Tallahassee-Perkins	Gretna*	\$ 169.29	\$ 2,728.64	\$0.001022
Tallahassee-Perkins	Havana*	\$ 169.29	\$ 2,728.64	\$0.001022
Tallahassee-Perkins	Hosford*	\$ 169.29	\$ 2,728.64	\$0.001022
Tallahassee-Perkins	Quincy*	\$ 169.29	\$ 2,728.64	\$0.001022
Tallahassee-Perkins	Tallahassee-Willis	\$ 117.53	\$ 1,364.32	\$0.001022
Tallahassee-Perkins	Tallahassee Thomasville	\$ 195.52	\$ 2,728.64	\$0.001022
Tallahassee-Willis	Alligator Point*	\$ 441.79	ICB	\$0.001022
Tallahassee-Willis	Bristol*	\$ 94.27	\$ 1,364.32	\$0.001022
Tallahassee-Willis	Carrabelle*	\$ 441.79	ICB	\$0.001022
Tallahassee-Willis	Chattahoochee*	\$ 441.79	ICB	\$0.001022
Tallahassee-Willis	Greensboro*	\$ 94.27	\$ 1,364.32	\$0.001022
Tallahassee-Willis	Gretna*	\$ 94.27	\$ 1,364.32	\$0.001022
Tallahassee-Willis	Havana*	\$ 94.27	\$ 1,364.32	\$0.001022
Tallahassee-Willis	Hosford*	\$ 94.27	\$ 1,364.32	\$0.001022
Tallahassee-Willis	Quincy*	\$ 94.27	\$ 1,364.32	\$0.001022
Tallahassee Blairstone	Alligator Point*	\$ 441.79	ICB	\$0.001022
Tallahassee Blairstone	Bristol*	\$ 169.29	\$ 2,728.64	\$0.001022
Tallahassee Blairstone	Carrabelle*	\$ 441.79	ICB	\$0.001022
Tallahassee Blairstone	Chattahoochee*	\$ 441.79	ICB	\$0.001022
Tallahassee Blairstone	Greensboro*	\$ 169.29	\$ 2,728.64	\$0.001022
Tallahassee Blairstone	Gretna*	\$ 169.29	\$ 2,728.64	\$0.001022
Tallahassee Blairstone	Havana*	\$ 169.29	\$ 2,728.64	\$0.001022
Tallahassee Blairstone	Hosford*	\$ 169.29	\$ 2,728.64	\$0.001022
Tallahassee Blairstone	Quincy*	\$ 169.29	\$ 2,728.64	\$0.001022
Tallahassee Blairstone	Tallahassee-Calhoun	\$ 117.53	\$ 1,364.32	\$0.001022
Tallahassee Blairstone	Tallahassee-FSU	\$ 195.52	\$ 2,728.64	\$0.001022
Tallahassee Blairstone	Tallahassee-Mabry	\$ 117.53	\$ 1,364.32	\$0.001022
Tallahassee Blairstone	Tallahassee-Perkins	\$ 195.52	\$ 2,728.64	\$0.001022
Tallahassee Blairstone	Tallahassee-Willis	\$ 117.53	\$ 1,364.32	\$0.001022
Tallahassee Blairstone	Tallahassee Thomasville	\$ 195.52	\$ 2,728.64	\$0.001022
Tallahassee Thomasville	Alligator Point*	\$ 519.78	ICB	\$0.001022
Tallahassee Thomasville	Bristol*	\$ 169.29	\$ 2,728.64	\$0.001022
Tallahassee Thomasville	Carrabelle*	\$ 519.78	ICB	\$0.001022
Tallahassee Thomasville	Chattahoochee*	\$ 519.78	ICB	\$0.001022
Tallahassee Thomasville	Greensboro*	\$ 169.29	\$ 2,728.64	\$0.001022
Tallahassee Thomasville	Gretna*	\$ 169.29	\$ 2,728.64	\$0.001022
Tallahassee Thomasville	Havana*	\$ 169.29	\$ 2,728.64	\$0.001022
Tallahassee Thomasville	Hosford*	\$ 169.29	\$ 2,728.64	\$0.001022
Tallahassee Thomasville	Quincy*	\$ 169.29	\$ 2,728.64	\$0.001022
Tallahassee Thomasville	Tallahassee-Willis	\$ 117.53	\$ 1,364.32	\$0.001022
Tavares	Umatilla	\$ 271.52	\$ 5,678.32	\$0.001022
Trilacoochee	Zephyrhills*	\$ 169.29	\$ 2,728.64	\$0.001022
Wauchula	Zolfo Springs	\$ 170.27	\$ 3,496.42	\$0.001022
West Kissimmee	Celebration*	\$ 94.27	\$ 1,364.32	\$0.001022
West Kissimmee	Haines City*(427)	\$ 245.29	\$ 4,860.74	\$0.001022
Williston	Bronson*	\$ 94.27	\$ 1,364.32	\$0.001022
Windermere	Celebration*	\$ 218.09	\$ 4,092.96	\$0.001022
Windermere	East Orange*	\$ 218.09	\$ 4,092.96	\$0.001022
Windermere	Lake Buena Vista*	\$ 218.09	\$ 4,092.96	\$0.001022

SPRINT - FLORIDA
TRANSPORT

Originating	Terminating	Dedicated DS1	Dedicated DS3	Common
Windermere	Orlando*	\$ 218.09	\$ 4,092.96	\$0.001022
Windermere	Winter Garden	\$ 117.53	\$ 1,364.32	\$0.001022
Windermere	Winter Park	\$ 169.29	\$ 2,728.64	\$0.001022
Winter Garden	Celebration*	\$ 169.29	\$ 2,728.64	\$0.001022
Winter Garden	East Orange*	\$ 143.06	\$ 2,728.64	\$0.001022
Winter Garden	Lake Buena Vista*	\$ 169.29	\$ 2,728.64	\$0.001022
Winter Garden	Orlando*	\$ 143.06	\$ 2,728.64	\$0.001022
Winter Garden	Winter Park	\$ 94.27	\$ 1,364.32	\$0.001022
Winter Park	Celebration*	\$ 143.06	\$ 2,728.64	\$0.001022
Winter Park	East Orange*	\$ 94.27	\$ 1,364.32	\$0.001022
Winter Park	Geneva*	\$ 94.27	\$ 1,364.32	\$0.001022
Winter Park	Lake Buena Vista*	\$ 143.06	\$ 2,728.64	\$0.001022
Winter Park	Orlando*	\$ 94.27	\$ 1,364.32	\$0.001022
Winter Park	Oviedo*	\$ 94.27	\$ 1,364.32	\$0.001022
Winter Park	Sanford*	\$ 94.27	\$ 1,364.32	\$0.001022

PART C - ATTACHMENT III

NETWORK ELEMENTS

Section 1. General

Pursuant to the following terms, Sprint will unbundle and separately price and offer Unbundled Network Elements such that CLEC will be able to subscribe to and interconnect to whichever of these unbundled elements CLEC requires for the purpose of providing local telephone service to its end-users. It is CLEC's obligation to combine Sprint-provided elements with any facilities and services that CLEC may itself provide.

Section 2. Unbundled Network Elements

2.1 Sprint shall offer Network Elements to CLEC for the purpose of offering Telecommunication Services to CLEC subscribers. Sprint shall offer Network Elements to CLEC on an unbundled basis on rates, terms and conditions that are just, reasonable, and non-discriminatory in accordance with the terms and conditions of this Agreement. The set of Network Elements include:

- 1) Local Loop
- 2) Network Interface Device (NID)
- 3) Switching Capability
 - Local Switching
 - Tandem Switching
- 4) Interoffice Transmission Facilities
 - Dedicated
 - Common
- 5) Signaling Networks & Call Related Databases
- 6) Operations Support Systems
- 7) Operator Services & Directory Assistance
- 8) Additional UNE's are listed in Exhibit 3.

2.2 CLEC may use one or more Network Elements to provide any feature, function, capability, or service option that such Network Element(s) is technically capable of providing.

2.3 Standards for Network Elements

2.3.1 Each Network Element provided by Sprint to CLEC shall be at Parity with the quality of design, performance, features, functions, capabilities and other characteristics, including but not limited to levels and types of redundant equipment and facilities for power, diversity and security, that Sprint provides to itself, Sprint's own subscribers, to a Sprint Affiliate or to any other entity.

Section 3. Loop

3.1 Definition

3.3.1 A "Loop" is a transmission path between the main distribution frame [cross-connect], or its equivalent, in a Sprint Central Office or wire center, and up to the Network Interface Device at a customer's premises, to which CLEC is granted exclusive use. This includes, but is not limited to, two-wire and four-wire cooper analog voice-grade loops, two-wire and four-wire loops that are conditioned to transmit the digital signals needed to provide services such as ISDN and DS1-level signals. This also includes DS-3, OC-n and STS-n services (e.g., n = 1,3,12...). Sprint will also provide conditioned loops (e.g., ADSL, HDSL) for Telecommunications Services requiring loop unfettered by any intervening equipment (e.g., filters, load coils, range extenders) so that CLEC can use these loops for a variety of Telecommunications Services that can be supported by use of copper by attaching appropriate terminal equipment at the ends.

3.2 Digital Loops

3.2.1 Sprint will provide loops conditioned for ADSL and HDSL without electronic terminal equipment at the ends unless otherwise specified by CLEC. If Sprint does not have available the facilities requested by CLEC or if the service requested exceeds the spectrum compatibility of the transmission path, then CLEC will issue a Bona Fide Request to Sprint for the appropriate facilities.

3.2.2 Sprint requires CLEC to provide in writing the grade of service desired in a particular loop (e.g., ISDN-BRI, PRI, ADSL, HDSL, DS1, etc.) so that the loop may be engineered to meet the appropriate spectrum compatibility requirements. If CLEC requires a change in the grade of service of a particular loop, e.g. changing from ISDN service to ADSL, CLEC shall notify Sprint in writing of

the requested change in grade of service. If Sprint finds that it is not technically feasible to provide the new level of service to CLEC, Sprint will notify CLEC that it is unable to meet CLEC's request. If a particular grade of service is installed but CLEC uses the loop to provide a service that exceeds the engineered capacity of a medium (i.e., interferes with other services) a mutually agreed upon process will be developed to resolve the issue.

3.2.3 If Sprint uses Integrated Digital Loop Carrier or other similar remote concentration devices, Sprint will make alternative arrangements at CLEC's request, to provide an unbundled local loop. Alternative arrangements may include copper facilities, dedicated transmission equipment or the deployment of newer devices providing for multiple hosting. The cost of modifications will be recovered from the requesting CLEC.

3.2.4 Reverse ADSL Loops - all ADSL ATU-C units in Sprint's network, including those integrated into DSLAMs, should either reside within a Sprint host or remote central office. If an ADSL copper loop should start at an outside location, and looped through a host or remote, and then onto the customer, the copper plant from the outside location to the Sprint central office must be a facility dedicated to ADSL transmission only and not part of Sprint's regular feeder or distribution plant.

3.3 CLEC shall meet the power spectral density requirement given in the respective technical references listed below:

3.3.1 For Basic Rate ISDN: Bellcore TR-NWT-000393 Generic Requirements for ISDN Basic Access Digital Subscriber Lines.

3.3.2 For HDSL installations: Bellcore TA-NWT-001210 Generic Requirements for High-Bit-Rate Digital Subscriber Lines. Some fractional T1 derived products operating at 768 kbps may use the same standard.

3.3.3 For ADSL: ANSI T1.413-1995 (Issue 1) Asymmetrical Digital Subscriber Line (ADSL) Metallic Interface. Note: Issue 2 of the standard will be balloted soon. It will drop an option that was in Issue 1 called Power Boost. Sprint does not permit the Power Boost option used in its local network.

3.3.4 As an alternative to Sections 3.3.1, 3.3.2, and 3.3.3, CLEC may meet the requirements given in ANSI document T1E1.4/97-180R1, "Normative Text for Spectral Compatibility Evaluations" dated June 30, 1997.

Section 4. Local Switching

4.1 Definition:

4.1.1 Local Switching is the Network Element that provides the functionality required to connect the appropriate lines or trunks wired to the Main Distributing Frame (MDF) or Digital Cross Connect (DSX) panel to a desired line or trunk. Such functionality shall include all of the features, functions, and capabilities that the underlying Sprint switch providing such Local Switching function provides for Sprint's own services. Functionality may include, but is not limited to: line signaling and signaling software, digit reception, dialed number translations, call screening, routing, recording, call supervision, dial tone, switching, telephone number provisioning, announcements, calling features and capabilities (including call processing), Centrex, or Centrex like services, Automatic Call Distributor (ACD), CLEC pre-subscription (e.g., long distance Carrier, intraLATA toll), Carrier Identification Code (CIC) portability capabilities, testing and other operational features inherent to the switch and switch software.

4.2 Technical Requirements

4.2.1 Sprint shall provide its standard recorded announcements (as designated by CLEC) and call progress tones to alert callers of call progress and disposition. CLEC will use the BFR process for unique announcements in accordance with Section 6 of Part A of this Agreement.

4.2.2 Sprint shall change a subscriber from Sprint's Telecommunications Services to CLEC's Telecommunications Services without loss of feature functionality unless expressly agreed otherwise by CLEC.

4.2.3 Sprint shall control congestion points such as mass calling events, and network routing abnormalities, using capabilities such as Automatic Call Gapping, Automatic Congestion Control, and Network Routing Overflow. Application of such control shall be competitively neutral and not favor any user of unbundled switching or Sprint.

4.2.4 Sprint shall offer all Local Switching features that are technically feasible and provide feature offerings at Parity with those provided by Sprint to itself or any other party.

4.3 Interface Requirements:

4.3.1 Sprint shall provide the following interfaces to loops:

4.3.1.1 Standard Tip/Ring interface including loopstart or groundstart, on-hook signaling (e.g., for calling number, calling name and message waiting lamp);

4.3.1.2 Coin phone signaling;

4.3.1.3 Basic and Primary Rate Interface ISDN adhering to ANSI standards Q.931, Q.932 and appropriate Bellcore Technical Requirements;

4.3.1.4 Two-wire analog interface to PBX to include reverse battery, E&M, wink start and DID;

4.3.1.5 Four-wire analog interface to PBX to include reverse battery, E&M, wink start and DID;

4.3.1.6 Four-wire DS1 interface to PBX or subscriber provided equipment (e.g., computers and voice response systems);

4.4 Sprint shall provide access to interfaces, including but not limited to:

4.4.1 SS7 Signaling Network, Dial Plus or Multi-Frequency trunking if requested by CLEC;

4.4.2 Interface to CLEC operator services systems or Operator Services through appropriate trunk interconnections for the system; and

4.4.3 Interface to CLEC directory assistance services through the CLEC switched network or to Directory Services through the appropriate trunk interconnections for the system; and 950 access or other CLEC required access to interexchange carriers as requested through appropriate trunk interfaces.

Section 5: Directory Assistance Service

5.1 Sprint shall provide for the routing of directory assistance calls (including but not limited to 411, 555-1212, NPA-555-1212) dialed by CLEC subscribers directly to, at CLEC's option, either (a) the CLEC DA service platform to the extent Sprint's switch can perform this customized routing, or (b) Sprint's DA service platform to the extent there is a DA service platform for that serving area.

5.1.1 Sprint shall provide CLEC with the same level of support for the provisioning of Directory Assistance as Sprint provides itself. Quality of service standards shall be measured at the aggregate level in accordance with standards and performance measurements that are at Parity with the standards and/or performance measurements that Sprint uses and/or which are required by law or regulatory agency rules or orders.

5.1.2 Directory Assistance services provided by Sprint to CLEC subscribers shall be branded in accordance with Section 11 of Part A of this Agreement.

5.1.3 At CLEC's request, Sprint will (where available) provide to CLEC operators, or to a CLEC-designated operator bureau, on-line access to Sprint's Directory Assistance Service, where such access is identical to the type of access Sprint's own directory assistance operators utilize in order to provide directory assistance services to Sprint end users.

Section 6 Operator Services

6.1 Sprint shall provide for the routing of local Operator Services calls (including but not limited to 0+, 0-) dialed by CLEC subscribers directly to either the CLEC operator Service platform or Sprint Operator Service platform to the extent Sprint's switch can perform this customized routing.

6.1.1 Sprint shall provide Operator Services to CLEC as described below until, at CLEC's discretion, Sprint routes calls to the CLEC Local Operator Services platform.

6.1.1.1 Sprint agrees to provide CLEC subscribers the same Operator Services available to Sprint subscribers. Sprint shall make available its service enhancements on a non-discriminatory basis.

6.1.1.1.2 Operator Services provided to CLEC subscribers shall be branded in accordance with Section 11 of Part A of this Agreement.

6.1.2 Sprint shall exercise the same level of fraud control in providing Operator Service to CLEC that Sprint provides for its own operator service.

Section 7 Transport

7.1 Common Transport

7.1.1 Definition: Common Transport provides a local interoffice transmission path between the Sprint tandem switch and a Sprint or CLEC end office switch. Common transport is shared between multiple customers and is required to be switched at the tandem.

7.1.2 Sprint shall offer Common Transport at DS0, DS1, DS3, STS-1 or higher transmission bit rate circuits.

7.1.3 Sprint shall be responsible for the engineering, provisioning, and maintenance of the underlying equipment and facilities that are used to provide Common Transport

7.2 Dedicated Transport

7.2.1 Definition: Dedicated Transport provides a local interoffice transmission path between Sprint and/or CLEC central offices. Dedicated transport is limited to the use of a single customer and does not require switching at a tandem.

7.2.2 Technical Requirements

Where technologically feasible and available, Sprint shall offer Dedicated Transport consistent with the underlying technology as follows:

7.2.2.1 When Sprint provides Dedicated Transport as a circuit or a system, the entire designated transmission circuit or system (e.g., DS1, DS3, STS-1) shall be dedicated to CLEC designated traffic.

7.2.2.2 Where Sprint has technology available, Sprint shall offer Dedicated Transport using currently available technologies including, but not limited to, DS1 and DS3 transport systems, SONET (or SDH) Bi-directional Line Switched Rings, SONET (or SDH) Unidirectional Path Switched Rings, and SONET (or SDH) point-to-point transport systems (including linear add-drop systems), at all available transmission bit rates.

Section 8 Tandem Switching

8.1 Definition:

Tandem Switching is the function that establishes a communications path between two switching offices (connecting trunks to trunks) through a third switching office (the tandem switch) including but not limited to CLEC, Sprint, independent telephone companies, IXCs and wireless Carriers. A host/remote end office configuration is not a Tandem Switching arrangement.

8.2 Technical Requirements

8.2.1 The requirements for Tandem Switching include, but are not limited to, the following:

8.2.1.1 Interconnection to Sprint tandem(s) will provide CLEC local interconnection for local and toll access service purposes to the Sprint end offices and NXXs which interconnect with that tandem(s) either directly or through other Sprint facilities for local and toll service purposes, and to other companies which are likewise connected to that tandem(s).

8.2.1.2 Interconnection to a Sprint tandem for transit purposes will provide CLEC interexchange access to Sprint, Interexchange Carriers ("IXCs"), Carriers, ILECs, and CMRS providers which are connected to that tandem.

8.2.1.3 Where a Sprint Tandem Switch also provides End-Office Switch functions, interconnection to a Sprint tandem serving that exchange will also provide CLEC access to Sprint's end offices and access the NXXs served by that individual end-office.

8.2.2 Tandem Switching shall preserve CLASS/LASS features and Caller ID as traffic is processed.

8.2.3 To the extent technically feasible, Tandem Switching shall record billable events and send them to the area billing centers designed by CLEC.

8.2.4 Tandem Switching shall control congestion using capabilities such as Automatic Congestion Control and Network Routing Overflow. Congestion control provided or imposed on CLEC traffic shall be at Parity with controls being provided or imposed on Sprint traffic (e.g. Sprint shall not block CLEC traffic and leave its traffic unaffected or less affected.)

8.2.5 The Local Switching and Tandem Switching functions may be combined in an office. If this is done, both Local Switching and Tandem Switching shall provide all of the functionality required of each of those Network Elements in this Agreement.

8.2.6 Tandem Switching shall provide interconnection to the E911 PSAP where the underlying Tandem is acting as the E911 Tandem.

8.3 Interface Requirements

8.3.1 Tandem Switching shall interconnect, with direct trunks, to all carriers with which Sprint interconnects.

8.3.2 Sprint shall provide all signaling necessary to provide Tandem Switching with no loss of feature functionality.

Section 9 Network Interface Device

9.1 Definition:

The Network Interface Device (NID) is a single-line termination device or that portion of a multiple-line termination device required to terminate a single line or circuit. The function of the NID is to establish the network demarcation point between a carrier and its subscriber. The NID features two independent chambers or divisions which separate the service provider's network from the subscriber's inside wiring. Each chamber or division contains the appropriate connection points or posts to which the service provider, and the subscriber each make their connections. The

NID or protector provides a protective ground connection, provides protection against lightning and other high voltage surges and is capable of terminating cables such as twisted pair cable.

9.1.1 CLEC may connect its NID to Sprint's NID; may connect an unbundled loop to its NID; or may connect its own Loop to Sprint's NID.

9.1.2 With respect to multiple-line termination devices, CLEC shall specify the quantity of NIDs it requires within such device.

Figure 1 shows a schematic of a NID.

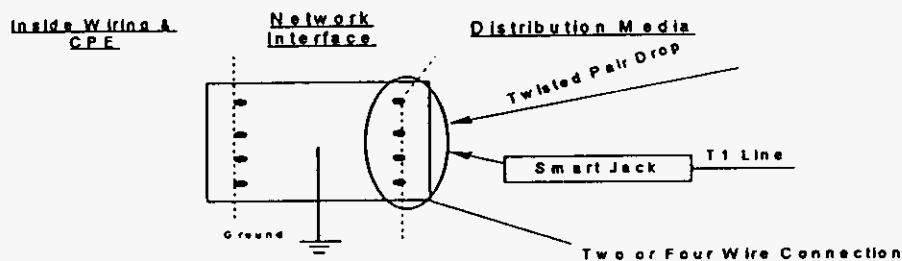

Figure 1 - Network Interface Device

9.2 Technical Requirements

9.2.1 The Sprint NID shall provide a clean, accessible point of connection for the inside wiring and for the Distribution Media and/or cross connect to CLEC's NID and shall maintain a connection to ground that meets the requirements set forth below. Each party shall ground its NID independently of the other party's NID.

9.2.2 The NID shall be the interface to subscribers' premises wiring for all loop technologies.

Section 10 Signaling Systems and Databases

10.1 Signaling Systems

10.1.1 Signaling Link Transport

10.1.1.1 Definition:

Signaling Link Transport is a set of two or four dedicated 56 Kbps transmission paths between CLEC-designated Signaling Points of Interconnection (SPOI) that provides appropriate physical diversity and a cross connect at a Sprint STP site.

10.1.1.2 Technical Requirements

10.1.1.2.1 Signaling Link Transport shall consist of full duplex mode 56 Kbps transmission paths.

10.1.1.3 Interface Requirements

10.1.1.3.1 There shall be a DS1 (1.544 Mbps) interface at the CLEC-designated SPOIs. Each 56 Kbps transmission path shall appear as a DS0 channel within the DS1 interface.

10.1.2 Signaling Transfer Points (STPs)

10.1.2.1 Definition:

Signaling Transfer Points (STPs) provide functionality that enable the exchange of SS7 messages among and between switching elements, database elements and signaling transfer points.

10.1.2.1.1 Figure 2 depicts Signaling Transfer Points.

Signaling Transfer Points.

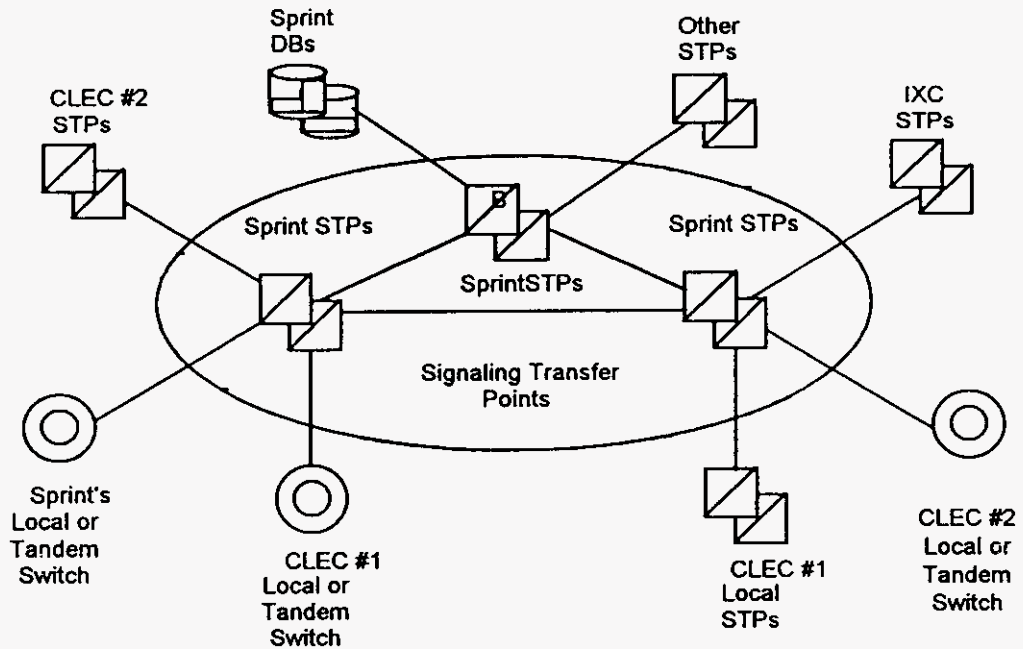

Figure 2

10.1.2.2 Technical Requirements

STPs shall provide access to and fully support the functions of all other Network Elements connected to the Sprint SS7 network. These include:

- 10.2.2.2.1 Sprint Local Switching or Tandem Switching;
- 10.2.2.2.2 Sprint Service Control Points/DataBases;
- 10.2.2.2.3 Third-party local or Tandem Switching systems; and
- 10.2.2.2.4 Third-party-provided STPs.

10.1.2.3 Interface Requirements

10.1.2.3.1 Sprint shall provide the following STPs options to connect CLEC or CLEC-designated local switching systems or STPs to the Sprint SS7 network:

10.1.2.3.1.1 An A-link interface from CLEC local switching systems; and,

10.1.2.3.1.2 B or D-link interface from CLEC STPs.

10.1.2.3.2 Each type of interface shall be provided by one or more sets (layers) of signaling links, as follows:

10.1.2.3.2.1 An A-link layer shall consist of two links, as depicted in Figure 3.

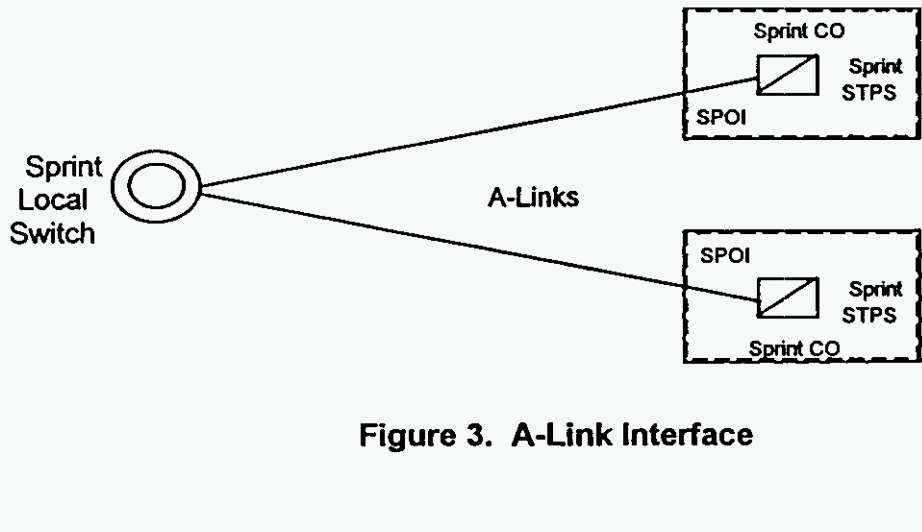

Figure 3. A-Link Interface

10.1.2.3.2.2 A B or D-link layer shall consist of four links, as depicted in Figure 4.

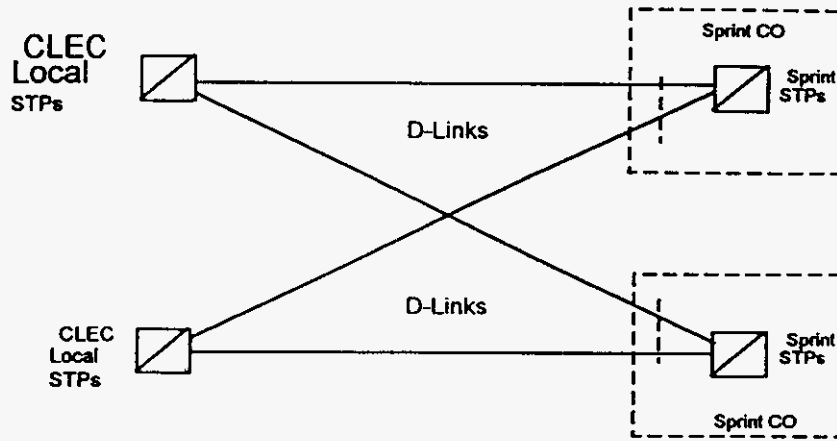

Figure 4. D-Link Interface

10.1.2.3.3 Signaling point of Interconnection (SPOI) for each link shall be located at a cross-connect element, such as a DSX-1, in the Central Office (CO) where the Sprint STPs is located. There shall be a DS1 or higher rate transport interface at each of the SPOIs. Each signaling link shall appear as a DSO channel within the DS1 or higher rate interface.

10.2 Line Information Database (LIDB)

10.2.1 The LIDB is a transaction-oriented database accessible through Common Channel Signaling (CCS) networks. It contains records associated with subscribers Line Numbers and Special Billing Numbers. LIDB accepts queries from other Network Elements, or CLEC's network, and provides appropriate responses. The query originator need not be the owner of LIDB data. LIDB queries include functions such as screening billed numbers that provides the ability to accept Collect or Third Number Billing calls and validation of Telephone Line Number based non-proprietary calling cards. The interface for the LIDB functionality is the interface between the Sprint CCS network and other CCS networks. LIDB also interfaces to administrative systems. The administrative system interface provides Work Centers with an interface to LIDB for functions such as provisioning, auditing of data, access to LIDB measurements and reports.

10.2.2 Technical Requirements

10.2.2.1 Prior to the availability of a long-term solution for Number Portability, Sprint shall enable CLEC to store in Sprint's LIDB any subscriber Line Number or Special Billing Number record, whether ported or not, for which the NPA-NXX or NXX-0/1XX Group is supported by that LIDB.

10.2.2.2 Prior to the availability of a long-term solution for Number Portability, Sprint shall enable CLEC to store in Sprint's LIDB any subscriber Line Number or Special Billing Number record, whether ported or not, and NPA-NXX and NXX-0/1XX Group Records, belonging to an NPA-NXX or NXX-0/1 XX owned by CLEC.

10.2.2.3 Subsequent to the availability of a long-term solution for Number Portability, Sprint shall enable CLEC to store in Sprint's LIDB any subscriber Line Number or Special Billing Number record, whether ported or not, regardless of the number's NPA-NXX or NXX-0/1XX.

10.2.2.4 Sprint shall perform the following LIDB functions for CLEC's subscriber records in LIDB: Billed Number Screening (provides information such as whether the Billed Number may accept Collect or Third Number Billing calls); and Calling Card Validation.

10.2.2.5 Sprint shall process CLEC's subscriber records in LIDB at Parity with Sprint subscriber records, with respect to other LIDB functions. Sprint shall indicate to CLEC what additional functions (if any) are performed by LIDB in their network.

10.2.2.6 Sprint shall perform backup and recovery of all of CLEC's data in LIDB at Parity with backup and recovery of all other records in the LIDB, including sending to LIDB all changes made since the date of the most recent backup copy.

10.3 Toll Free Number Database

10.3.1 Definition

10.3.1.1 The Toll Free Number Database provides functionality necessary for toll free (e.g., 800 and 888) number services by providing routing information and additional vertical features during call set-up in response to queries from SSPs. Sprint shall provide the Toll Free Number Database in accordance with the following:

10.3.2 Technical Requirements

10.3.2.1 Sprint shall make the Sprint Toll Free Number Database available for CLEC to query, from CLEC's designated switch including Sprint unbundled local switching with a toll-free number and originating information.

10.3.2.2 The Toll Free Number Database shall return carrier identification and, where applicable, the queried toll free number, translated numbers and instructions as it would in response to a query from a Sprint switch.

10.3.3 Interface Requirements

10.3.3.1 The signaling interface between the CLEC or other local switch and the Toll-Free Number database shall use the TCAP protocol, together with the signaling network interface.

PART C - ATTACHMENT IV

INTERCONNECTION

Section 1. Local Interconnection Trunk Arrangement

1.1 The Parties agree to initially use 2-Way trunks (1-way directionalized) for an interim period of 120 days after date of initial trunk turn-up. Either Party may extend the use of 1-way trunks for an additional 30 days, if necessary for engineering and billing purposes; provided that the Parties shall transition all 1-way trunks established under this Agreement.

1.1.1 The Parties shall initially reciprocally terminate Local Traffic and IntraLATA/InterLATA toll calls originating on each others' networks as follows:

1.1.1.1 The Parties shall make available to each other two-way trunks for the reciprocal exchange of combined Local Traffic, and non-equal access IntraLATA toll traffic.

1.1.1.2 Separate two-way trunks will be made available for the exchange of equal-access InterLATA or IntraLATA interexchange traffic that transits Sprint's network. Upon agreement between CLEC and Sprint, equal access InterLATA and/or IntraLATA traffic may be combined on the same trunk group as Local Traffic, non-equal access IntraLATA toll traffic, and local transit traffic.

1.1.1.3 Separate trunks will be utilized for connecting CLEC's switch to each 911/E911 tandem.

1.1.1.4 Separate trunk group will be utilized for connecting CLEC's Operator Service Center to Sprint's Operator Service Center to Operator- assisted busy line interrupt/verify.

1.1.1.5 Separate trunk group will be utilized for connecting CLEC's to Sprint's Directory Assistance Center in instances where CLEC is purchasing Sprint's unbundled Directory Assistance service.

1.2 Point of Interconnection

1.2.1 "Point of Interconnection" or "POI" means the physical point that establishes the technical interface, the test point, and the operational responsibility hand-off between CLEC and Sprint for the local interconnection of their networks.

1.2.2 CLEC will be responsible for engineering and maintaining its network on its side of the POI. Sprint will be responsible for engineering and maintaining its network on its side of the POI. If and when the parties choose to interconnect at a mid-span meet, CLEC and Sprint will jointly provision the facilities that connect the two networks. Sprint will be required to provide fifty (50) percent of the facilities or to its exchange boundary, whichever is less. CLEC will be required to provide fifty (50) percent of the facilities or to Sprint's exchange boundary, whichever is greater.

Section 2. Compensation Mechanisms

2.1 Point of Interconnection

2.1.1 Each party is responsible for bringing their facilities to the POI.

2.2 Compensation for Local Traffic Transport and Termination

2.2.2 The POI determines the point at which the originating carrier shall pay the terminating carrier for the completion of that traffic. The following compensation elements shall apply:

2.2.2.1 "Transport", which includes the two rate elements of transmission and any necessary Tandem Switching of Local Traffic from the interconnection point between the two carriers to the terminating carrier's end-office switch that directly serves the called end-user.

2.2.2.2 "Termination", which includes the switching of Local Traffic at the terminating carrier's end office switch.

2.3 When a CLEC subscriber places a call to Sprint's subscriber, CLEC will hand off that call to Sprint at the POI. Conversely, when Sprint hands over Local Traffic to CLEC for CLEC to transport and terminate, Sprint may use the established POI or Sprint may designate its own POI.

2.4 CLEC and Sprint may designate a POI at any technically feasible point including but not limited to any electronic or manual cross-connect points, collocations, entrance facilities, and mid-span meets. The transport and termination charges for Local Traffic flowing through a POI shall be as follows:

2.4.1 When calls from CLEC are terminating on Sprint's network through the Sprint Tandem Switch, CLEC will pay Sprint for transport charges from the POI to the Tandem for dedicated transport. CLEC shall also pay a charge for Tandem Switching, common transport to the end office, and end-office termination.

2.4.2 When Sprint terminates calls to CLEC's subscribers using CLEC's switch, Sprint shall pay CLEC for transport charges from the POI to the CLEC switching center for dedicated transport. Sprint shall also pay to CLEC a charge symmetrical to its own charges for the functionality actually provided by CLEC for call termination.

2.4.3 CLEC may choose to establish direct trunking to any given end office. If CLEC leases trunks from Sprint, it shall pay charges for dedicated transport. For calls terminating from CLEC to subscribers served by these directly-trunked end offices, CLEC shall also pay an end-office termination. For Sprint traffic terminating to CLEC over the direct end office trunking, compensation payable by Sprint shall be the same as that detailed in Section 2.4.2 above.

Section 3. Signaling

3.1 Signaling protocol. The parties will interconnect their networks using SS7 signaling where technically feasible and available as defined in FR 905 Bellcore Standards including ISDN user part ("ISUP") for trunk signaling and transaction capabilities application part ("TCAP") for CCS-based features in the interconnection of their networks. All Network Operations Forum (NOF) adopted standards shall be adhered to.

3.2 Refer to Attachment III, Section 10 for detailed terms of SS7 Network Interconnection.

3.3 Standard interconnection facilities shall be extended superframe (ESF) with B8ZS line code. Where ESF/B8ZS is not available, CLEC will agree to using other interconnection protocols on an interim basis until the standard ESF/B8ZS is available. Sprint will provide anticipated dates of availability for those areas not currently ESF/B8ZS compatible.

3.3.1 Where CLEC is unwilling to utilize an alternate interconnection protocol, CLEC will provide Sprint an initial forecast of 64 Kbps clear channel capability ("64K CCC") trunk quantities within 30 days of the Approval Date consistent with the forecasting agreements between the parties. Upon receipt of this forecast, the parties will begin joint planning for the engineering, procurement, and installation of the segregated 64K CCC Local Interconnection Trunk Groups, and the associated B8ZS extended super frame ("ESF") facilities, for the sole purpose of transmitting 64K CCC data calls between CLEC and Sprint. Where additional equipment is required, such equipment would be obtained, engineered, and installed on the same basis and with the same intervals as any similar growth job for IXC, CLEC, or Sprint internal customer demand for 64K CCC trunks. Where technically feasible, these trunks will be established as two-way.

Section 4. Network Servicing

4.1 Trunk Forecasting:

4.1.1 The Parties shall work towards the development of joint forecasting responsibilities for traffic utilization over trunk groups. Orders for trunks that exceed forecasted quantities for forecasted locations will be accommodated as facilities and or equipment are available. The Parties shall make all reasonable efforts and cooperate in good faith to develop alternative solutions to accommodate orders when facilities are not available. Intercompany forecast information must be provided by the Parties to each other twice a year. The semi-annual forecasts shall include:

4.1.1.1 Semi-annual forecasted trunk quantities (which include baseline data that reflect actual Tandem and end office Local Interconnection and meet point trunks and Tandem-subtending Local Interconnection end office equivalent trunk requirements for no more than two years (current plus one year);

4.1.1.2 The use of Common Language Location Identifier (CLLI-MSG), which are described in Bellcore documents BR 795-100-100 and BR 795-400-100;

4.1.1.3 Description of major network projects that affect the other Party will be provided in the semi-annual forecasts. Major network projects include but are not limited to trunking or network rearrangements, shifts in anticipated traffic patterns, or other activities by either party that are reflected by a significant increase or decrease in trunking demand for the following forecasting period.

4.1.2 Parties shall meet to review and reconcile their forecasts if forecasts vary significantly.

4.1.3 Each Party shall provide a specified point of contact for planning forecasting and trunk servicing purposes.

4.1.4 Trunking can be established to Tandems or end offices or a combination of both via either one-way or two-way trunks. Trunking will be at the DS-0 level, DS-1 level, DS-3/OC-3 level, or higher, as agreed upon by CLEC and Sprint. Initial trunking will be established between the CLEC switching centers and Sprint's access Tandem(s). The Parties may utilize direct end office trunking depending upon Tandem exhaust, traffic volumes, or by mutual agreement.

4.1.5 The parties agree to abide by the following:

4.1.5.1 In the event that CLEC over-forecasts its trunking requirements by 20% or more, and Sprint acts upon this forecast to its detriment, Sprint may recoup any actual and reasonable expense it occurs.

4.1.5.2 The calculation of the 20% over-forecast will be based on the number of DS-1 equivalents for the total traffic volume to Sprint.

4.1.5.3 Expenses will only be recouped for non-recoverable facilities that cannot otherwise be used at any time within twelve (12) months after the initial installation for another purpose including but not limited to: other traffic growth between the parties, internal use, or use with another party.

4.2 Grade of Service

4.2.1 A blocking standard of one percent (.01) during the average busy hour, as defined by each Party's standards, for final trunk groups between a CLEC end office and a Sprint access Tandem carrying meet point traffic shall be maintained. All other final trunk groups are to be engineered with a blocking standard of one percent (.01). Direct end office trunk groups are to be engineered with a blocking standard of one percent (.01).

4.3 Trunk Servicing

4.3.1 Orders between the Parties to establish, add, change or disconnect trunks shall be processed by use of an ASR, or another industry standard eventually adopted to replace the ASR for local service ordering.

Section 5. Network Management

5.1 Protective Protocols

5.1.1 Either Party may use protective network traffic management controls such as 7-digit and 10-digit code gaps on traffic toward each others network, when required to protect the public switched network from congestion due to facility failures, switch congestion or failure or focused overload. CLEC and Sprint will immediately notify each other of any protective control action planned or executed.

5.2 Expansive Protocols

5.2.1 Where the capability exists, originating or terminating traffic reroutes may be implemented by either party to temporarily relieve network congestion due to facility failures or abnormal calling patterns. Reroutes will not be used to circumvent normal trunk servicing. Expansive controls will only be used when mutually agreed to by the parties.

5.3 Mass Calling

5.3.1 CLEC and Sprint shall cooperate and share pre-planning information, where available, regarding cross-network call-ins expected to generate large or focused temporary increases in call volumes, to prevent or mitigate the impact of these events on the public switched network.

Section 6. Usage Measurement

6.1 Each Party shall calculate terminating interconnection minutes of use based on standard AMA recordings made within each Party's network, these recordings being necessary for each Party to generate bills to the other Party. In the event either Party cannot measure minutes terminating on its network, the other Party shall provide the measuring mechanism or the Parties shall otherwise agree on an alternate arrangement.

6.2 Measurement of minutes of use over Local Interconnection trunk groups shall be in actual conversation seconds. The total conversation seconds over each individual Local Interconnection trunk group will be totaled for the entire monthly bill period and then rounded to the next whole minute.

6.3 Prior to the commencement of billing for interconnection, each party shall provide to the other, the Percent Local Use (PLU) of the traffic terminated to each other over the Local Interconnection trunk groups.

6.3.1 Where possible, within 20 business days after the end of each quarter (commencing with the first full quarter after the effective date of this Agreement), each party will provide to the other a usage report for the purpose of updating the PLU, showing the total traffic volume described in terms of minutes and messages and by jurisdiction (local and toll) terminated to each other over the Local Interconnection trunk groups.

6.3.2 Otherwise the parties will agree on an alternate method for the development of the PLU.

Section 7. Transit Traffic

7.1 Definition

Transit Traffic means the delivery of local or intraLATA toll and switched traffic by Carrier or Sprint originated by the end user of one Party and terminated to a third party LEC, ILEC, or CMRS provider over the local/intraLATA interconnection trunks. The following traffic types will be delivered by either Party: local traffic and intraLATA toll and switched traffic originated from Carrier or Sprint and delivered to such third party LEC, ILEC or CMRS; and intraLATA 800 traffic.

7.2 Terms and Conditions

7.2.1 Each Party acknowledges that it is the originating Party's responsibility to enter into arrangements with each third party LEC, ILEC, or CMRS provider for the exchange of transit traffic to that third party.

7.2.2 Each Party acknowledges that the transiting Party does not have any responsibility to pay any third party LEC, ILEC, or CMRS provider charges for termination or any identifiable transit traffic from the originating Party. Both Parties reserve the right not to pay such charges on behalf of the originating Party.

7.3. Payment Terms and Conditions

7.3.1 In addition to the payment terms and conditions contained in other sections of this Agreement, the Parties shall compensate each other for transit service as follows:

7.3.1.1 The originating Party shall pay to the transiting Party a transit service charge as set forth in the Pricing Schedule; and

7.3.1.2 If the terminating company requests, and the transiting company does not provide, the terminating company with the originating record in order for the terminating company to bill the originating company, the terminating Party shall default bill the transiting Party for transited traffic which does not identify the originating company.

7.4 Billing Records and Exchange of Data

7.4.1 Parties will use the best efforts to convert all networks transporting transit traffic to deliver each call to the other Party's network with SS7 Common Channel Interoffice Signaling (CCIS) and other appropriate Transactional Capability Application Party (TCAP) messages in order to facilitate full interoperability and billing functions.

7.4.2 The transiting Party agrees to provide the terminating Party information on traffic originated by a third party LEC, ILEC, or CMRS provider. To the extent Sprint incurs additional cost in providing this billing information, CLEC agrees to reimburse Sprint for its direct costs of providing this information.

7.4.3 To the extent that the industry adopts a standard record format for recording originating and/or terminating transit calls, both Parties agree to comply with the industry-adopted format to exchange records.

Section 8. Responsibilities Of The Parties

8.1 Sprint and CLEC agree to treat each other fairly, nondiscriminatorily, and equally for all items included in this Agreement, or related to the support of items included in this Agreement.

8.2 Sprint and CLEC will review engineering requirements consistent with the Implementation Plan described in Part A, Section 31 and Part C, Attachment IV, Section 4 and otherwise as set forth in this Agreement.

8.3 CLEC and Sprint shall share responsibility for all Control Office functions for Local Interconnection Trunks and Trunk Groups, and both parties shall share the overall coordination, installation, and maintenance responsibilities for these trunks and trunk groups.

8.4 CLEC is responsible for all Control Office functions for the meet point trunking arrangement trunks and trunk groups, and shall be responsible for the overall coordination, installation, and maintenance responsibilities for these trunks and trunk groups.

8.5 CLEC and Sprint shall:

8.5.1 Provide trained personnel with adequate and compatible test equipment to work with each other's technicians.

8.5.2 Notify each other when there is any change affecting the service requested, including the due date.

8.5.3 Coordinate and schedule testing activities of their own personnel, and others as applicable, to ensure its interconnection trunks/trunk groups are installed per the interconnection order, meet agreed-upon acceptance test requirements, and are placed in service by the due date.

8.5.4 Perform sectionalization to determine if a trouble is located in its facility or its portion of the interconnection trunks prior to referring the trouble to each other.

8.5.5 Advise each other's Control Office if there is an equipment failure which may affect the interconnection trunks.

8.5.6 Provide each other with a trouble reporting/repair contact number that is readily accessible and available 24 hours, 7 days a week. Any changes to this contact arrangement must be immediately provided to the other party.

8.5.7 Provide to each other test-line numbers and access to test lines.

8.5.8 Cooperatively plan and implement coordinated repair procedures for the meet point and Local Interconnection trunks and facilities to ensure trouble reports are resolved in a timely and appropriate manner.

PART C - ATTACHMENT V

COLLOCATION

Section 1. Introduction

This Attachment sets forth the requirements for Collocation.

Section 2. Technical Requirements

2.1 Sprint shall provide space, as requested by CLEC, to meet CLEC's needs for placement of equipment, interconnection, or provision of service ("Collocated Space") in accordance with this Attachment V and Sprint's FCC #1 tariff and Florida tariff.

2.1.1 CLEC shall not occupy or use the Collocated Space, or permit the Collocated Space to be occupied or used, for any purpose, act or thing, whether or not otherwise permitted by this Agreement, if such purpose, act or thing (i) is in violation of any public law, ordinance or governmental regulation; (ii) may be dangerous to persons or property; (iii) may invalidate or increase the amount of premiums beyond such increase as results from the contemplated occupancy for any insurance policy carried on the building or covering its operation; or (iv) violates the terms of this Agreement.

2.2 Sprint shall provide intraoffice facilities (e.g., DS0, DS-1, DS-3,-and other available transmission speeds) as agreed to by CLEC and Sprint to meet CLEC's need for placement of equipment, interconnection, or provision of service.

2.3 Sprint agrees to allow CLEC's employees and designated agents unrestricted but escorted access to CLEC dedicated space in manned Sprint offices twenty-four (24) hours per day each day of the week. CLEC shall use reasonable efforts to provide Sprint twenty-four (24) hours prior notice of such access. Sprint may place reasonable security restrictions, including an escort requirement and charge for such escort, on access by CLEC's employees and designated agents to the Collocated Space in unmanned Sprint offices. Notwithstanding the above, in the event Sprint constructs CLEC dedicated space escorted access may not be required as mutually agreed by the Parties. Sprint agrees that such space shall be available to CLEC's employees and designated agents twenty-four (24) hours per day each day of the week upon twenty-four (24) hours prior notice. In no case should any reasonable security restrictions be more

restrictive than those Sprint places on their own personnel, except with respect to an escort requirement as set forth above.

2.4 CLEC may collocate the amount and type of equipment it deems necessary in its Collocated Space in accordance with FCC Rules and Regulations and Sprint's FCC #1 tariff and Sprint-Florida Incorporated Access Service Tariff. Such equipment shall meet Bellcore specifications and be manufactured by a Sprint approved vendor. Approved vendors will, at a minimum, be vendors Sprint currently approves for its own use. Sprint will approve additional vendors provided they meet industry standards.

2.5 Sprint shall permit a collocating telecommunications carrier to interconnect its network with that of another collocating telecommunications carrier at the Sprint premises and to connect its collocated equipment to the collocated equipment of another telecommunications carrier within the same premises. Sprint in all cases shall provide such interconnections.

2.6 Sprint shall permit CLEC or its designated subcontractor to perform the construction of physical collocation arrangements, provided, however, that any such CLEC subcontractor shall be subject to Sprint's approval, such approval shall not be unreasonably withheld. Approval by Sprint shall be based on the same criteria it uses in approving contractors for its own purposes.

2.7 CLEC shall not make substantial installations, alterations or additions in or to the Collocated Space without submitting plans and specifications to Sprint and securing the prior written consent of Sprint in each instance. Sprint's consent shall not be unreasonably withheld or unduly delayed for non-structural interior alteration to the Collocated Space that do not adversely affect the building's appearance, value, structural strength and mechanical integrity. Such work shall be done at the sole expense of CLEC.

2.7.1 All installations, alterations and additions shall be constructed in a good and workmanlike manner and only new and good grades of material shall be used, and shall comply with all insurance requirements, governmental requirements, and terms of this Agreement. Work shall be performed at such times and in such manner as to cause a minimum of interference with Sprint's transaction of business. CLEC shall permit Sprint to inspect all construction operations within the premises and to approve contractors, which approval shall not be unreasonably withheld. If alterations are made by CLEC's contractors, CLEC shall furnish to

Sprint prior to commencement thereof, building permits and certificates of insurance to be provided by CLEC's contractors and sub-contractors. Any such insurance to be provided by CLEC's contractors or sub-contractors shall provide for coverage in amounts not less than as required by Sprint of CLEC under Section 2.45 of this Attachment V. Upon completion of any installation, alteration or addition, contractor's affidavits and full and final waivers of lien covering all labor and material expended and used shall be furnished to Sprint. CLEC and its contractors and sub-contractors shall hold Sprint harmless from all claims, costs, damages, liens and expenses which may arise out of or be connected in any way with installations, alterations or additions.

2.7.2 All installations, alterations and additions which take the form of fixtures, except trade fixtures, placed in the Collocated Space by and at the expense of CLEC or others shall become the property of Sprint, and shall remain upon and be surrendered with the Collocated Space. Upon termination of a license for Collocated Space, however, Sprint shall have the right to require CLEC to remove such fixtures and installations, alterations or additions at CLEC's expense, and to surrender the Collocated Space in the same condition as it was prior to the making of any or all such improvements, reasonable wear and tear excepted.

2.7.3 All fixtures and other equipment to be used by CLEC in, about or upon the premises shall be subject to the prior written approval of Sprint, which shall not be unreasonably withheld.

2.8 Sprint shall provide basic telephone service with a connection jack as ordered by CLEC from Sprint for the Collocated Space. Upon CLEC's request, this service shall be available at the Collocated Space on the day that the space is turned over to CLEC by Sprint.

2.9 Sprint shall provide adequate lighting, ventilation, power, heat, air conditioning, and other environmental conditions for CLEC's space and equipment. These services are included in the CLEC's floor space monthly payment. These environmental conditions shall adhere to Bellcore Network Equipment Building System (NEBS) standards TR-EOP-000063 or other mutually agreed standards.

2.9.1 If CLEC locates equipment or facilities in the Collocated Space which Sprint determines affect the temperature or other environmental conditions otherwise maintained by Sprint in the building, Sprint reserves the right to provide and install supplementary air conditioning units or other environmental control

devices for the Collocated Space, and the cost of providing, installing, operating and maintaining any such supplementary air conditioning units or other environmental control devices made necessary solely by CLEC's equipment or facilities shall be paid by CLEC to Sprint upon agreement by both Parties and as mutually agreed.

2.9.2 If CLEC's equipment or facilities requires cooling capability in excess of that normally provided by Sprint for its own equipment, any required supplementary air conditioning required by CLEC shall be paid by CLEC to Sprint upon agreement by both Parties and as mutually agreed.

2.10 Where available and subject to Sprint's standard security procedures, Sprint shall provide access to eyewash stations, shower stations, bathrooms, and drinking water within the collocated facility on a twenty-four (24) hours per day, seven (7) days per week basis for CLEC personnel and its designated agents.

2.11 Sprint shall provide all ingress and egress of fiber and power cabling to Collocated Spaces. CLEC's specific diversity requirements for each site or Network Element will be provided in the collocation request.

2.12 Each party shall ensure protection of the other party's proprietary subscriber information. In conjunction with any collocation arrangement Sprint and CLEC shall adhere to the provisions of Section 12 of Part A of this Agreement.

2.13 Sprint shall participate in and adhere to negotiated and agreed to service guarantees and Performance Standards, if any.

2.14 Sprint shall provide CLEC with written notice five (5) business days prior to those instances where Sprint or its subcontractors may be performing work in the general area of the Collocated Space, or in the general area of the AC and DC power plants which support CLEC equipment. Sprint will inform CLEC by telephone of any emergency related activity that Sprint or its subcontractors may be performing in the general area of the Collocated Space, or in the general area of the AC and DC power plants which support CLEC equipment. Notification of any emergency related activity shall be made immediately prior to the start of the activity so that CLEC can take any action required to monitor or protect its service.

2.15 Sprint shall, at its sole expense, except as hereinafter provided, provide repair and maintenance of heating, cooling and lighting equipment and regularly scheduled refurbishments or decorating to the Collocated Space, building and property, in a manner consistent with Sprint's normal business practices.

2.15.1 Sprint shall, where practical, provide CLEC with 24 hours prior notice before making repairs and/or performing maintenance on the Collocated Space; provided, however, that Sprint shall have no obligation to provide such notice if Sprint determines, in the exercise of its sole discretion, that such repair or maintenance must be done sooner in order to preserve the safety of the building or the Collocated Space, or if required to do so by any court or governmental authority. Work shall be completed during normal working hours or at other times identified by Sprint; provided, however, that CLEC shall pay Sprint for overtime and for any other expenses incurred if such work is done during other than normal working hours at CLEC's request. CLEC shall have the right, at its sole expense, to be present during repair or maintenance of the Collocated Space.

2.16 CLEC shall provide Sprint with written notice five (5) business days prior to those instances where CLEC or its subcontractors may be performing work in the general area of the Collocated Space, or in the general area of the AC and DC power plants which support Sprint equipment. CLEC will inform Sprint by telephone of any emergency related activity that CLEC or its subcontractors may be performing in the general area of the Collocated Space, or in the general area of the AC and DC power plants which support Sprint equipment. Notification of any emergency related activity shall be made immediately prior to the start of the activity so that Sprint can take any action required to monitor or protect its service.

2.17 To the extent Sprint performs the construction of the physical collocation arrangement, Sprint shall construct the Collocated Space in compliance with mutually agreed collocation request. Any deviation to CLEC's order must thereafter be approved by CLEC.

2.18 CLEC and Sprint will complete an acceptance walk through of those portions of the collocation arrangement provided by Sprint. Exceptions that are noted during this acceptance walk through shall be corrected by Sprint within five (5) business days after the walk through except where circumstances reasonably warrant additional time. In such event, subject to CLEC's consent, which shall not be unreasonably

withheld, Sprint shall be given additional time. The correction of these exceptions from the original collocation request shall be at Sprint's expense.

2.19 Sprint shall provide detailed Telephone Equipment drawings depicting the exact location, type, and cable termination requirements (i.e., connector type, number and type of pairs, and naming convention) for Sprint Point of Termination Bay(s) to CLEC within ten (10) business days of acceptance of CLEC's request for Collocated Space.

2.20 Sprint shall provide detailed drawings depicting the exact path, with dimensions, for CLEC Outside Plant Fiber ingress and egress into Collocated Space within ten (10) business days of the acceptance of CLEC's request for Collocated Space.

2.21 Sprint shall provide detailed power cabling connectivity information including the sizes and number of power feeders to CLEC within ten (10) business days of the acceptance of CLEC's request for Collocated Space.

2.22 To the extent Sprint performs the construction of the physical collocation arrangement, Sprint shall provide positive confirmation to CLEC when construction of Collocated Space is 50% completed. This confirmation shall also include confirmation of the scheduled completion and turnover dates.

2.23 Sprint shall provide the following information to CLEC within ten (10) business days of receipt of a written request from CLEC:

2.23.1 Work restriction guidelines.

2.23.2 Sprint or Industry technical publication guidelines that impact the design of Sprint collocated equipment.

2.23.3 Sprint contacts (names and telephone numbers) for the following areas:

- Engineering
- Physical & Logical Security
- Provisioning
- Billing (Related to Collocation Services)
- Operations
- Site and Building Managers
- Environmental and Safety

2.23.4 Escalation process for the Sprint employees (names, telephone numbers and the escalation order) for any disputes or problems that might arise pursuant to CLEC's collocation.

2.24 Power as referenced in this document refers to any electrical power source supplied by Sprint for CLEC equipment. It includes all superstructure, infrastructure, and overhead facilities, including, but not limited to, cable, cable racks and bus bars. Sprint will supply power to support CLEC equipment at equipment specific DC and AC voltages. At a minimum, Sprint shall supply power to CLEC at Parity with that provided by Sprint to itself or to any third party. If Sprint performance, availability, or restoration falls below industry standards, Sprint shall bring itself into compliance with such industry standards as soon as technologically feasible.

2.24.1 Central office power supplied by Sprint into the CLEC equipment area, shall be supplied in the form of power feeders (cables) on cable racking into the designated CLEC equipment area. The power feeders (cables) shall efficiently and economically support the requested quantity and capacity of CLEC equipment. The termination location shall be as requested by CLEC.

2.24.2 Sprint shall provide power as requested by CLEC to meet CLEC's need for placement of equipment, interconnection, or provision of service.

2.24.3 Sprint power equipment supporting CLEC's equipment shall:

2.24.3.1 Comply with applicable industry standards (e.g., Bellcore, NEBS and IEEE) or manufacturer's equipment power requirement specifications for equipment installation, cabling practices, and physical equipment layout or at minimum, at Parity with that provided for similar Sprint equipment;

2.24.3.2 Have redundant power feeds with physical diversity and battery back-up as required by the equipment manufacturer's specifications for CLEC equipment, or, at minimum, at Parity with that provided for similar Sprint equipment;

2.24.3.3 Provide, upon CLEC's request, the capability for real time access to power performance monitoring and alarm data that impacts (or potentially may impact) CLEC traffic;

2.24.3.4 Provide central office ground, connected to a ground electrode located within the Collocated Space, at a level above the top of CLEC equipment plus or minus 2 feet to the left or right of CLEC's final request; and

2.24.3.5 Provide feeder cable capacity and quantity to support the ultimate equipment layout for CLEC equipment in accordance with CLEC's collocation request.

2.24.3.6 To the extent Sprint performs the construction of physical collocation arrangements, Sprint shall, within ten (10) business days of CLEC's request:

2.24.3.6.1 The standard prices for collocation are as set forth in Sprint's tariffs, and nonstandard charges shall be negotiated between the parties.

2.24.3.6.2 Provide an installation schedule and access that will allow Sprint and CLEC installation efforts in parallel without jeopardizing either party's personnel safety or existing services;

2.24.3.6.3 Provide information on existing power plant alarms that adhere to Bellcore Network Equipment Building System (NEBS) standards TR-EOP-000063;

2.24.3.7 Sprint shall provide cabling that adheres to Bellcore Network Equipment Building System (NEBS) standards TR-EOP-000063; 2.24.3.8 Sprint shall provide Lock Out-Tag Out and other electrical safety procedures and devices in conformance with the most stringent of OSHA or industry guidelines.

2.24.4 Sprint will provide CLEC with written notification within ten (10) business days of any scheduled AC or DC power work or related activity in the collocated facility that will or might cause an outage or any type of power disruption to CLEC equipment located in Sprint facility. Sprint shall provide CLEC immediate notification by telephone of any emergency power activity that would impact CLEC equipment.

2.24.5 CLEC will provide Sprint with written notification within ten (10) business days of any scheduled AC or DC power work or related activity in the collocated facility that will or might cause an outage or any type of power disruption to Sprint equipment located in CLEC facility. CLEC shall provide Sprint immediate notification by telephone of any emergency power activity that would impact Sprint equipment.

2.25 To the extent that space for virtual collocation is available, Sprint shall provide virtual collocation where physical collocation is not practical for technical reasons or because of space limitations. Sprint shall take collocator demand into account when renovating existing facilities and constructing or leasing new facilities.

2.26 Where collocation space and associated requirements are available, intervals for physical collocation shall be a maximum of three months from the requested date, subject to additional time for asbestos removal or extraordinary construction as mutually agreed upon by CLEC and Sprint. Virtual collocations will have a maximum interval of 2 months.

2.27 CLEC may choose to lease unbundled transport from the Sprint, or from a third carrier, rather than construct to the Sprint facility where equipment will be collocated.

2.28 Sprint will maintain, at CLEC's expense, CLEC's virtually collocated equipment in a manner equal to that with which it maintains its own equipment. Maintenance includes the change out of electronic cards provided by CLEC and per CLEC's request.

2.29 As part of the license granted in Section 4 herein, CLEC, its employees, agents and invitees shall have a non-exclusive right to use those portions of the common area of the building as are designated by Sprint from time to time, including, but not limited to, the right to use rest rooms in proximity to the Collocated Space, corridors and other access ways from the entrance to the building, the Collocated Space, and the parking areas adjacent to the building for vehicles of persons while

working for or on behalf of CLEC at the Collocated Space; provided, however, that Sprint shall have the right to reserve parking spaces for Sprint's exclusive use or by other occupants of the building. Sprint does not guarantee that there is or will be sufficient parking spaces in parking areas to meet CLEC's needs. All common areas shall remain under the exclusive control and management of Sprint, and Sprint shall have the right to change the level, location and arrangement of parking areas and other common areas as Sprint may deem necessary. Use of all common areas shall be subject to such reasonable rules and regulations as Sprint may from time to time impose, such as those set forth in Section 2.3 of this Attachment V.

2.30 Where available, Sprint shall furnish passenger elevator service as necessary to reach the Collocated Space or common areas to which CLEC has access pursuant to the terms of this Attachment V 24 hours a day, seven days a week. Where available, freight elevator service when used by CLEC's contractors, employees or agents shall be provided at times reasonably satisfactory to Sprint.

2.31 CLEC shall regularly inspect the Collocated Space to ensure that the Collocated Space is in good working condition. CLEC shall promptly notify Sprint of any damage to the Collocated Space or of the need to perform any repair or maintenance of the Collocated Space, fixtures and appurtenances (including hardware, heating, cooling, ventilating, electrical and other mechanical facilities in the Collocated Space). CLEC shall keep the Collocated Space clean and trash free.

2.31.1 The cost of all repairs and maintenance performed by or on behalf of Sprint to the Collocation Space or building which are, in Sprint's reasonable judgment, beyond normal repair and maintenance, or are made necessary as a result of misuse or neglect by CLEC or CLEC's employees, invitees, or agents, shall be paid by CLEC to Sprint within 10 days after being billed for such repairs and maintenance by Sprint.

2.32 CLEC shall, with the prior written consent of Sprint, have the right to provide additional fire protection systems within the Collocated Space; provided, however, that CLEC may not install or use sprinklers or carbon dioxide fire suppression systems within the building or the Collocated Space. If any governmental bureau, department or organization or Sprint's insurance carrier requires that changes, modifications, or alterations be made to the fire protection system, or that additional stand alone fire extinguishing, detection or protection devices be supplied within the Collocated Space, such changes, modifications or additions shall be made by CLEC at it's expense, following review and approval by Sprint

prior to any work being done. If any governmental bureau, department or organization or Sprint's insurance carrier requires that changes or modifications be made to the fire protection system or that additional stand alone fire extinguishing, detection or protection devices be supplied within that portion of the building in which the Collocated Space of CLEC's in general are located, such changes, modifications, or additions shall be made by Sprint and CLEC shall reimburse Sprint for the cost thereof in the same proportion as the square footage of the Collocated Space as compared to the total square footage of the affected portion of the building.

2.33 CLEC, its employees, agents, contractors, and business invitees shall (i) comply with all rules and regulations which Sprint may from time to time adopt for the safety, environmental protection, care, cleanliness and/or preservation of the good order of the building, the property and the Collocated Space and its tenants and occupants, and (ii) comply, at its own expense, with all ordinances which are applicable to the Collocated Space and with all lawful orders and requirements of any regulatory or law enforcement agency requiring the correction, prevention and abatement of nuisances in or upon the Collocated Space during the term of this Agreement or any extension hereof.

2.34 CLEC shall not cut or drill into, drive nails or screws into, install conduit or wires, or in any way deface any part of the Collocated Space or the building, outside or inside, without the prior written consent of Sprint. If CLEC desires signal, communications, alarm or other utility or service connections installed or changed, the same shall be made by and at the expense of CLEC. Sprint shall have the right of prior approval of such utility or service connections, and shall direct where and how all connections and wiring for such service shall be introduced and run. In all cases, in order to maintain the integrity of the halon space for proper halon concentration, and to ensure compliance with Sprint's fireproofing policy, any penetrations by CLEC, whether in the Collocated Space, the building or otherwise, shall be sealed as quickly as possible by CLEC with Sprint-approved fire barrier sealants, or by Sprint at CLEC's cost.

2.35 CLEC shall not exceed the uniformly distributed live load capacity.

2.36 CLEC equipment within the Collocated Space shall be connected to Sprint's grounding system.

2.37 CLEC shall post in a prominent location visible from the common building area, the telephone numbers of emergency contact personnel for 24 hour emergency use by Sprint. CLEC will promptly update this information as changes occur.

2.38 CLEC shall not paint, display, inscribe or affix any sign, trademark, picture, advertising, notice, lettering or direction on any part of the outside or inside of the Sprint location, or on the Collocated Space, without the prior written consent of Sprint.

2.39 CLEC shall not use the name of the Sprint building or Sprint for any purpose other than that of the business address of CLEC, or use any picture or likeness of the Sprint building on any letterhead, envelope, circular, notice or advertisement, without the prior written consent of Sprint.

2.40 CLEC shall not exhibit, sell or offer for sale, rent or exchange in the Collocated Space or on the Sprint property any article, thing or service except those ordinarily embraced within the use of the Collocated Space specified in this Attachment V, without the prior written consent of Sprint.

2.41 CLEC shall not place anything or allow anything to be placed near the glass of any door, partition or window which Sprint determines is unsightly from outside the Collocated Space; take or permit to be taken in or out of other entrances of the Sprint building, or take or permit to be taken on any passenger elevators, any item normally taken through service entrances or elevators; or whether temporarily, or accidentally, or otherwise, allow anything to remain in, place, or store anything in, or obstruct in any way, any passageway, exit, stairway, elevator, or shipping platform. CLEC shall lend its full cooperation to keep such areas free from all obstruction and in a clean and sightly condition, move all supplies, furniture and equipment directly to the Collocated Space as soon as received, and move all such items and waste, other than waste customarily removed by employees of the building.

2.42 CLEC shall not do or permit anything to be done upon the premises, or bring or keep anything thereon which is in violation of any federal, state or local laws or regulations (including environmental laws or regulations not previously described), or any rules, regulations or requirements of the local fire department, Fire Insurance Rating Organization, or any other similar authority having jurisdiction over the building. CLEC shall not do or permit anything to be done upon the premises which may in any way create a nuisance, disturb, endanger, or otherwise interfere with the Telecommunications Services of Sprint, any other occupant of the building, their patrons or customers, or the occupants of neighboring property, or injure the reputation of the property.

2.42.1 CLEC shall not, without the prior written consent of Sprint:
(i) install or operate any lead-acid batteries, refrigerating, heating or air conditioning apparatus or carry on any mechanical business

in the premises; (ii) use the premises for housing, lodging, or sleeping purposes; (iii) permit preparation or warming of food, presence of cooking or vending equipment, sale of food or smoking in the premises; or (iv) permit the use of any fermented, intoxicating or alcoholic liquors or substances in the premises or permit the presence of any animals except those used by the visually impaired. Sprint may, in its sole discretion, withhold such consent, or impose any condition in granting it, and revoke its consent at will.

2.43 Sprint reserves the right to stop any service when Sprint deems such stoppage necessary by reason of accident or emergency, or for repairs improvements or otherwise; however, Sprint agrees to use its best efforts not to interfere with CLEC's use of the Collocation Space. Sprint does not warrant that any service will be free from interruptions caused by labor controversies, accidents, inability to obtain fuel, water or supplies, governmental regulations, or other causes beyond the reasonable control of Sprint.

2.43.1 No such interruption of service shall be deemed an eviction or disturbance of CLEC's use of the Collocation Space or any part thereof, or render Sprint liable to CLEC for damages, by abatement of collocation charges, except as set forth in the tariff, or relieve CLEC from performance of its obligations under this Agreement. CLEC hereby waives and releases all other claims against Sprint for damages for interruption or stoppage of service.

2.43.2 Sprint shall have the right to reduce heat, light, water and power as required by any mandatory or voluntary conservation programs.

2.44 Sprint shall have the following rights, and others not specifically excluded in this Agreement, exercisable without notice and without liability to CLEC for damage or injury to property, person or business (all claims for damage being hereby released), and without effecting an eviction or disturbance of CLEC's use or possession or giving rise to any claim for offsets, or abatement of rent:

2.44.1 To change the name or street address of the building;

2.44.2 To install and maintain signs on the exterior and interior of the building or anywhere on the property;

2.44.3 To designate all sources furnishing sign painting and lettering, ice, mineral or drinking water, beverages, foods, towels, vending machines or toilet supplies used or consumed on the premises;

2.44.4 To use any means Sprint may deem proper to open Collocation Space doors in an emergency. Entry into the Collocation Space obtained by Sprint by any such means shall not be deemed to be forcible or unlawful entry into or a detainment of or an eviction of CLEC from the Collocation Space or any portion thereof;

2.44.5 To utilize the space within the building in such a manner as will best enable it to fulfill its own service requirements;

2.44.6 At any time, to decorate and to make, at its own expense, repairs, alterations, additions, and improvements, structural or otherwise, in or to the premises, the property, or any part thereof (including, without limitation, the permanent or temporary relocation of any existing facilities such as parking lots or spaces), and to perform any acts related to the safety, protection or preservation thereof, and during such operations to take into and through the premises or any part of the property all material and equipment required, and to close or suspend temporarily operation of entrances, doors, corridors, elevators or other facilities, provided that Sprint shall limit inconvenience or annoyance to CLEC as reasonably possible under the circumstances;

2.44.7 To do or permit to be done any work in or about the Collocation Space or the property or any adjacent or nearby building, land, street or alley;

2.44.8 To grant to anyone the exclusive right to conduct any business or render any service on the property, provided such exclusive right shall not operate to exclude CLEC from the use expressly permitted by this Agreement;

2.44.9 If it becomes necessary in Sprint's reasonable judgment, and there are no other reasonable alternatives, to require CLEC to move to equivalent Collocation Space in the building upon receipt of ninety (90) days written notice from Sprint, in which event, Sprint shall pay all moving costs, and the charges for collocation provided for herein shall remain the same; and

2.44.10 To designate all spaces occupied by CLEC's facilities under this Agreement.

2.45 CLEC shall carry insurance, at CLEC's expense, insuring CLEC and, except for worker's compensation, and showing Sprint as additional insured and/or loss payee, as its interest may appear. Such insurance shall contain such terms and conditions and provide such coverages and exclusions as are standard in the industry and be written by companies having an AM Best Rating of not less than A - .

2.45.1 As of the date that CLEC begins construction of any portion of a physical collocation arrangement or as of the date that CLEC begins to occupy any physical collocation arrangement under this Agreement, whichever is earlier, CLEC shall maintain the following coverages in the following amounts; provided, however, that material changes to the CLEC's collocation arrangements will allow Sprint to ask for reasonably proportional changes in insurance.

2.45.1.1 Commercial general liability, occurrence form, in limits of not less than \$1,000,000 combined single limit for bodily injury, personal injury and property damage liability insurance to include coverage for products/completed operations and explosion, collapse and underground liability;

2.45.1.2 "All Risk" property insurance on a full replacement cost basis, insuring CLEC's real and personal property situated on or within the property. CLEC may elect to insure business interruption and contingent business interruption, as it is agreed that Sprint has no liability for loss of profit or revenues should an interruption of service occur;

2.45.1.3 Business auto insurance, including all owned, non-owned and hired automobiles, in an amount of not less than \$1,000,000 combined single limit for bodily injury and property damage liability;

2.45.1.4 Worker's compensation insurance in accordance with statutory requirements, and employer's liability with a minimum amount of \$500,000 per accident; and

2.45.1.5 Umbrella or excess liability in an amount not less than \$5,000,000 per occurrence and aggregate to provide excess limits over all primary liability coverages.

2.45.2 The limits of the insurance policies obtained by CLEC as required above shall in no way limit CLEC's liability to Sprint should CLEC be liable to Sprint under the terms of this Agreement or otherwise.

2.45.3 CLEC shall furnish to Sprint a certificate or certificates of insurance, satisfactory in form and content to Sprint, evidencing that the above coverage is in force and has been endorsed and to guarantee that the coverage will not be canceled or materially altered without first giving at least 30 days prior written notice to Sprint.

2.45.4 All policies of insurance shall be written as primary policies and not contributing with or in excess of the coverage, if any, that Sprint may carry. Any other provisions contained in this Section, this Attachment or this Agreement notwithstanding, the amounts of all insurance required to be obtained by CLEC shall not be less than an amount sufficient to prevent Sprint from becoming a co-insurer.

2.46 If the premise or a portion thereof sufficient to make the premises substantially unusable shall be destroyed or rendered unoccupiable by fire or other casualty, Sprint may, at its option, restore the premises to its previous condition. A license granted under this Attachment shall not terminate unless, within 90 days after the occurrence of such casualty, Sprint notifies CLEC of its election to terminate said license. If Sprint does not elect to terminate said license, Sprint shall repair the damage to the premises caused by such casualty.

2.46.1 Notwithstanding any other contrary provision of this Agreement, if any casualty is the result of any act, omission or negligence of CLEC, its agents, employees, contractors, licensees, customers or Sprint business invitees, unless Sprint otherwise elects, a license for Collocation Space shall not terminate, and, if Sprint elects to make such repairs, CLEC shall reimburse Sprint for the cost of such repairs, or CLEC shall repair such damage, including damage to the building and the area surrounding it. The charges to be paid to Sprint by CLEC shall not abate.

2.46.2 Notwithstanding any other contrary provision of this Agreement, if any casualty is the result of any act, omission or negligence of Sprint, its agents, employees, contractors, licensees, customers or CLEC business invitees, unless CLEC otherwise elects, a license for Collocation Space shall not terminate, and, if CLEC elects to make such repairs, Sprint shall reimburse CLEC for the cost of such repairs, or Sprint shall repair such damage, including damage to the building and the area surrounding it

2.46.3 If the building shall be damaged by fire or other casualty to the extent that portions are rendered unoccupiable, notwithstanding that the Collocation Space may be directly unaffected, Sprint may, at its election within 90 days of such casualty, terminate a license for Collocation Space by giving written notice of its intent to terminate said license. The termination as provided in this paragraph shall be effective 30 days after the date of the notice.

2.46.4 Notwithstanding any other provision of this Agreement, Sprint shall not be liable for any repair or restoration until, and then only to the extent that, insurance proceeds are received.

2.47 If the property, or any portion thereof which includes a substantial part of the Collocation Space, shall be taken or condemned by any competent authority for any public use or purpose, the term of a Collocation Space license shall end upon, and not before, the date when the possession of the part so taken shall be required for such use or purpose. If any condemnation proceeding shall be instituted in which it is sought to take or damage any part of the property, or if the grade of any street or alley adjacent to the property is changed by any competent authority and such change of grade makes it necessary or desirable to remodel the property to conform to the changed grade, Sprint shall have the right to terminate a Collocation Space license upon not less than 30 days notice prior to the date of cancellation designated in the notice. No money or other consideration shall be payable by Sprint to CLEC for such cancellation, and CLEC shall have no right to share in the condemnation award or in any judgment for damages caused by such eminent domain proceedings.

2.48 At the termination of a Collocation Space license by lapse of time or otherwise:

2.48.1 CLEC shall surrender all keys, access cards and Sprint-provided photo identification cards to the Collocation Space and the building to Sprint, and shall make known to Sprint the combination of all combination locks remaining on the Collocation Space.

2.48.2 CLEC shall remove its equipment from the Collocation Space within thirty (30) days.

2.48.3 CLEC shall return to Sprint the Collocation Space and all equipment and fixtures of Sprint in as good a condition and state of repair as when CLEC originally took possession, normal wear and tear or damage by fire or other casualty excepted. CLEC shall be responsible to Sprint for the cost of any repairs that shall be made necessary by the acts or omissions of CLEC or of its agents, employees, contractors or business invitees. Sprint reserves the right to oversee CLEC's withdrawal from the Collocation Space and CLEC agrees to comply with all directives of Sprint regarding the removal of equipment and restoration of the Collocation Space, including, without limitation, Sprint's directive to return the Collocation Space in other than its original condition on the date of occupancy; provided, however, that CLEC shall not be responsible for putting the Collocation Space in other than its original condition if to do so would put CLEC to additional expense above and beyond that which would be necessary to return the Collocation Space in its original condition,

2.48.4 All installations, additions, hardware, non-trade fixtures and improvements, temporary or permanent, except movable furniture and equipment belonging to CLEC, in or upon the Collocation Space, whether placed there by CLEC or Sprint, shall be Sprint's property and shall remain upon or in the Collocation Space, all without compensation, allowance or credit to CLEC; provided, however, that if prior to such termination or within ten (10) days thereafter, Sprint so directs, CLEC shall promptly remove the installations, additions, hardware, non-trade fixtures and improvements, placed in or upon the Collocation Space by CLEC, failing which Sprint may remove the same, and CLEC shall, upon demand, pay to Sprint the cost of such removal and of any necessary restoration of the Collocation Space. No cable shall be removed from inner duct or outside cable duct except as directed by Sprint.

2.48.5 All fixtures, installations, and personal property belonging to CLEC not removed from the Collocation Space upon termination of a Collocation Space license and not required by Sprint to have been removed as provided in this Attachment V, shall be conclusively presumed to have been abandoned by CLEC and title thereto shall pass to Sprint under this Attachment V as if by a bill of sale.

2.48.6 If the Collocation Space is not surrendered at the termination of the Collocation Space license, CLEC shall indemnify Sprint against loss or liability resulting from delay by CLEC in so surrendering the Collocation Space, including, without limitation, any claims made by any succeeding tenant founded on such delay.

2.49 If the owner of the building or Sprint sells, transfers or assigns any interest in the building, or there is any material change in the lease to which the building is subject, and such sale, transfer, assignment or material change in the lease gives rise to an obligation which is inconsistent with a Collocation Space license granted under this Attachment V, Sprint's performance under this Attachment V shall be excused to the extent of the inconsistency. Sprint hereby agrees that it will use its reasonable efforts to avoid any such inconsistency; provided, however, that this obligation shall in no way obligate Sprint to incur any out of pocket expenses in its efforts to avoid such inconsistencies.

2.50 A Collocation Space license granted under this Attachment V shall at all times be subject and subordinate to the lien of any mortgage (which term shall include all security instruments) that may be placed on the premises, building or any portion thereof and CLEC agrees, upon demand, to execute any instrument as may be required to effectuate such subordination.

Section 3. Physical Security

3.1 Each party shall exercise the same degree of care [but not less than reasonable] to prevent harm or damage to the other party or its employees, agents or subscribers, or their property. Sprint and its employees, agents or representatives shall take reasonable and prudent steps to ensure the adequate protection of CLEC property, equipment and services including, but not limited to:

3.1.1 Restricting access to CLEC equipment, support equipment, systems, tools, or spaces which contain or house CLEC equipment enclosures to CLEC employees and other authorized non-CLEC personnel to the extent necessary to perform their specific job function.

3.1.2 CLEC shall provide a written logbook for Sprint's employees to sign when entering CLEC's physical Collocation Space which houses or contains CLEC equipment or equipment enclosures.

3.1.3 Prior to Sprint's employees enter CLEC's physical Collocation Space, Sprint agrees to contact the designated CLEC representative twenty-four (24) hours in advance (with the exception of an emergency). Sprint's employees shall comply at all times with CLEC security and safety procedures and requirements, including but not limited to sign-in, identification, and escort requirements while in CLEC's physical Collocation Spaces which house or contain CLEC equipment or equipment enclosures. In the event any issues or problems arise under this Section 3.1 the parties agree to negotiate a reasonable resolution to such issue or problem.

3.1.4 Ensuring that the physical collocation area which houses CLEC's equipment is adequately secured and monitored to prevent unauthorized entry to the same extent and at the same level Sprint provides itself.

3.1.5 Subject to Section 2.3 of this Attachment V, allowing CLEC to inspect or observe spaces which house or contain CLEC equipment or equipment enclosures at any time and to furnish CLEC with all keys, entry codes, lock combinations, or other materials or information which may be needed to gain entry into any secured CLEC space.

3.1.6 Limiting the keys used in its keying systems for CLEC's physical Collocation Spaces which contains or houses CLEC equipment or equipment enclosures to Sprint employees and representatives to emergency access only. CLEC shall further have the right to change locks where deemed necessary for the protection and security of such spaces.

3.1.7 Upon CLEC's request, installing security studs in the hinge plates of doors having exposed hinges with removable pins if such leads to CLEC's physical Collocation Space which contains or houses CLEC equipment or equipment enclosures.

3.1.8 Controlling unauthorized access from passenger and freight elevators by continuous surveillance or by personnel security escort, installing security partitions, security grills, locked gates or doors between elevator lobbies and spaces which contain or house CLEC equipment or equipment enclosures.

3.1.9 Providing real time notification to designated CLEC personnel to indicate an actual or attempted security breach.

3.1.10 Subject to the provisions of Sections 2.9, 2.9.1 and 2.9.2 above, ensuring that areas designated to house CLEC equipment are environmentally appropriate for the CLEC equipment installation, and adequate to maintain proper operating conditions for the CLEC equipment.

3.2 Sprint, at CLEC's expense, may issue non-employee photo identification cards for each CLEC employee or vendor. Temporary identification cards may otherwise be provided by Sprint for employees or agents, contractors and invitees of CLEC who may require occasional access to the Collocated Space.

3.3 Sprint may issue access cards, codes, or keys to CLEC's listed employees or vendors where such systems are available and their use by CLEC will not otherwise compromise building security.

3.4 Sprint reserves the right to close and keep locked all entrance and exit doors of the building during hours Sprint may deem advisable for the adequate protection of the building.

3.5 CLEC agrees to abide by all of Sprint's security practices for non-Sprint employees with access to the building, including, without limitation:

3.5.1 CLEC will supply to Sprint, and update as changes occur, a list of its employees or approved vendors who require access to the building. The list will include the social security numbers of all such individuals.

3.5.2 CLEC is responsible for returning identification and access cards, codes, or keys of its terminated employees or its employees who no longer require access to the Collocated Space. All cards, codes, or keys must be returned upon termination of this Agreement. Unreturned or replacement cards, codes, or keys may be subject to a reasonable fee at the discretion of Sprint.

3.5.3 CLEC's employees, agents, invitees and vendors must display identification cards at all times.

3.5.4 CLEC will assist Sprint in validation and verification of identification of its employees, agents, invitees and vendors by providing a telephone contact available 24 hours a day, seven days a week to verify identification.

3.5.5 Before leaving the Collocated Space unattended, CLEC shall close and securely lock all doors and windows and shut off unnecessary equipment in the Collocated Space. Any damage resulting from CLEC's failure to do so shall be the responsibility of CLEC.

3.6 CLEC will allow Sprint to access its Collocated Space at all times, via pass key or otherwise, to allow Sprint to react to emergencies, to maintain the space (not including CLEC equipment), and to monitor compliance with the rules and regulations of the Occupational Health and Safety Administration or Sprint, or other regulations and standards including but not limited to those related to fire, safety, health, and environmental safeguards. Except in emergencies or unless CLEC has waived such notice elsewhere in this Attachment V, and if conditions permit, Sprint will provide CLEC with notice of its intent to access the Collocated Space, thereby providing CLEC the option to be present at the time of access. CLEC shall not attach, or permit to be attached, additional locks or similar devices to any door or window, nor change existing locks or the mechanism thereof.

Section 4. License

Sprint hereby grants CLEC a license to occupy any premises or rack space which contain collocated equipment, including without limit all necessary ingress, egress and reasonable use of Sprint's property, for the Term of the Agreement.

Section 5. Technical References

Sprint shall provide collocation in accordance with the following standards:

5.1 National Electrical Code (NEC) use latest issue.

5.2 TA-NPL-000286, NEBS Generic Engineering Requirements for System Assembly and Cable Distribution, Issue 2, (Bellcore, January 1989).

- 5.3 TR-EOP-000063 Network Equipment Building System (NEBS) Generic Equipment Requirements, Issue 3, March 1988.
- 5.4 TR-EOP-000151, Generic Requirements for 24-, 48-, 130-, and 140- Volt Central Office Power Plant Rectifiers, Issue 1, (Bellcore, May 1985).
- 5.5 TR-EOP-000232, Generic Requirements for Lead-Acid Storage Batteries, Issue 1 (Bellcore, June 1985).
- 5.6 TR-NWT-000154, Generic Requirements for 24-, 48-, 130, and 140- Volt Central Office Power Plant Control and Distribution Equipment, Issue 2, (Bellcore, January 1992).
- 5.7 TR-NWT-000295, Isolated Ground Planes: Definition and Application to Telephone Central Offices, Issue 2, (Bellcore, July 1992).
- 5.8 TR-NWT-000840, Supplier Support Generic Requirements (SSGR), (A Module of LSSGR, FR-NWT-000064), Issue 1, (Bellcore, December 1991).
- 5.9 TR-NWT-001275 Central Office Environment Installations/Removal Generic Requirements, Issue 1, January 1993.

PART C - ATTACHMENT VI

RIGHTS OF WAY (ROW), CONDUITS, POLE ATTACHMENTS

Section 1. Introduction

This attachment sets forth the requirements for Rights of Way, Conduits and Pole Attachments.

Section 2. Definitions

2.1 An "anchor" refers to a device, structure, or assembly which stabilizes a Pole and holds it in place. An anchor assembly may consist of a rod and fixed object or plate, typically embedded in the ground, which is attached to a guy strand or guy wire, which, in turn, is attached to the Pole. The term "anchor" does not include the guy strand which connects the anchor to the Pole.

2.2 An "Attachment" is any placement of CLEC's facilities in or on Sprint's Poles, ducts, conduits, or Right of Way.

2.3 A "conduit" is a tube or protected trough that may be used to house communication cables. Conduit may be underground or above ground (for example, inside buildings) and may contain one or more inner ducts.

2.4 A "conduit system" is any combination of ducts, conduits, manholes and handholes joined to form an integrated whole. Conduit systems may pass through or originate in or terminate in other facilities which may be physically connected to the conduit system.

2.5 A "duct" is a single enclosed path to house facilities to provide Telecommunications Services.

2.6 The terms "facility" and "facilities" refers to any property, equipment, or items owned or controlled by any person or entity. The terms "facility" and "facilities" include, but are not limited to, Poles, anchors, Pole hardware, wires, cables, strands, apparatus enclosures, or any other items attached to a Pole or attached to hardware affixed to or associated with a Pole; conduit and conduit systems and wires, cables, optical conductors, associated hardware, or other equipment located within a Conduit System. The terms "facility" and "facilities" may also include property, equipment, and items which do not occupy a conduit system or which are not attached to a Pole or attached to hardware affixed to or associated with a Pole.

2.7 An "inner duct" is one of the single enclosed pathways located within a duct, or buried separately without the benefit of a conduit.

2.8 The term "Make Ready Work" refers to all work performed or to be performed to prepare Sprint's Poles, Ducts, Conduits or other Right of Way for the requested occupancy or attachment of CLEC's facilities. "Make ready work" includes, but is not limited to, clearing obstructions, the rearrangement, transfer, replacement, and removal of existing facilities on a Pole or in a conduit system where such work is required solely to accommodate CLEC's facilities. "Make ready work" may include the repair, or modification of Sprint's facilities (including, but not limited to, conduits, ducts, or manholes) or the performance of other work required to make a Pole, conduit or duct usable for the placement of CLEC's facilities.

2.9 A "manhole" is a subsurface enclosure that personnel may enter and use for the purpose of installing, operating, maintaining, and repairing communications facilities.

2.10 A "handhole" is a subsurface enclosure that is too small for personnel to enter and is used for the purpose of installing, operating, maintaining, and repairing communications facilities.

2.11 A "Pole" refers to Sprint Poles and anchors and does not include poles or anchors with respect to which Sprint has no legal authority to permit attachments by other persons or entities.

2.12 A "Pole attachment" is the connection of a facility to a Pole. Some examples of such facilities are mechanical hardware, grounding and transmission cable, and equipment boxes.

2.13 A "Right of Way" ("ROW") is the right to use the land or other property of another party to place poles, conduits, cables, or other structures and equipment, or to provide passage to access such structures and equipment for the purpose of providing Telecommunications Services. A ROW may run under, on, or above public or private property (including air space above public or private property) and may include the right to use discrete space in buildings, building complexes, or other locations.

Section 3. Requirements

3.1 General

3.1.1 Sprint shall make Poles, ducts, conduits, conduit systems, and other ROW available to CLEC for Attachments under the terms and conditions set forth in this Section 3.

3.1.2 Sprint shall provide CLEC equal and non-discriminatory access to Poles, ducts, conduits, and other ROW, it owns or controls. Such access shall be provided on terms and conditions equal to that provided by Sprint to itself or to any other party consistent with Section 224 of the Act. Further, Sprint shall not preclude or delay allocation of these facilities to CLEC because of the potential needs of itself or of other parties, except for work in progress, which may be retained for Sprint facilities deployment within three hundred sixty-five (365) calendar days of the date of the formal CLEC request.

3.1.3 Each of the parties shall designate to the other, on the basis of specific operating regions, single points of contact for negotiating all issues relating to implementation of this Section 3. The single points of contact shall also be the contacts for all notices and demands, offers and acceptances under this Section 3, unless otherwise agreed in writing by the parties.

3.1.4 Excepting work in progress as described above, and maintenance and emergency ducts as provided below, all usable but unassigned space on Poles, or in ducts, conduits, or other ROW owned or controlled by Sprint shall be available for the attachments of CLEC, Sprint or other providers of Telecommunications Services or cable television systems. Sprint may reserve for emergency and maintenance purposes one duct in each conduit section of its facility routes. Such duct shall be equally accessible and available by any party with facilities in such conduit section to use to maintain its facilities or to restore them in an emergency.

3.1.5 All CLEC facilities placed in or upon Sprint ROW shall be clearly tagged or labeled with CLEC ownership identification so that it may be readily identified by Sprint or its contractors as CLEC facilities.

3.1.6 Access to Sprint Poles, ducts, conduits or other ROW by CLEC or its designated personnel or contractors shall be provided on an escorted basis and upon a reasonable request for access to such Poles, ducts, conduits or other ROW. CLEC shall pay for one access escort based on an hourly rate of the appropriate level of escorting personnel as determined by Sprint, unless Sprint and CLEC have reached agreement that no escort is necessary, which may be negotiated on a case by case basis. Such escort service shall be available on a reasonable basis 24 hours per day.

3.2 Pre-Ordering Disclosure Requirements

3.2.1 CLEC may request information regarding the availability and conditions of Poles, ducts, conduits and other ROW prior to the submission of Attachment Requests (as defined below). Sprint shall provide information regarding the availability and condition of Sprint's Poles, ducts, conduits or other ROW for Attachments within fifteen (15) business days of a request. If it is unable to inform CLEC about availability and conditions within such fifteen-day interval, Sprint shall advise CLEC within ten (10) business days after receipt of CLEC's information request and will seek a mutually satisfactory time period for Sprint's response, which in no event shall exceed thirty (30) calendar days. If Sprint's response requires a field-based survey, CLEC shall have the option to be present at the field-based survey and Sprint shall provide CLEC at least two (2) calendar days notice prior to the start of such field survey. During and after the field based survey, Sprint shall allow CLEC personnel (with Sprint escort) to enter manholes and view Pole structures to inspect such structures in order to confirm usability or assess the condition of the structure.

3.2.2 Sprint shall make existing route maps of Poles, ducts, conduits or other Right of Way available to CLEC, at a city level, at Sprint's facilities within two (2) business days and if such maps need to be generated, within ten (10) business days of CLEC's request. Preparation of such maps requested by CLEC shall be accommodated by Sprint on a reasonable basis and at CLEC's expense, plus a reasonable administrative fee. In making these maps and drawings available, Sprint makes no express or implied warranty as to the accuracy of these maps and drawings, except that they reflect the equivalent accuracy and timeliness of information used by Sprint in its operations.

3.2.3 Sprint shall invoice CLEC an administrative fee equal to one hundred percent (100%) of the direct cost of providing maps and drawings, in addition to the direct cost of copying any requested maps or drawings.

3.3 Attachment Requests

3.3.1 Sprint agrees to permit CLEC to place CLEC's facilities on or in Sprint's Poles, ducts, conduits, and other ROW pursuant to Attachment requests from CLEC approved in accordance with this Section 3.3, on the terms and conditions set forth herein and in the "Attachment Request".

3.3.2 At any time after the Approval Date, CLEC may submit a written Attachment Request, in a form to be designated by Sprint, to Sprint. An Attachment Request shall be deemed properly submitted if it identifies with specificity the Sprint Poles, ducts, conduits, or other ROW for which CLEC seeks Attachment. Sprint shall approve any properly submitted Attachment Request within ten (10) business days, if the space has previously been determined to be available under the procedures set forth in Section 3.2.1 of this Attachment VI above. No Attachments shall be placed on any Sprint Pole identified in an Attachment Request until the Attachment Request has been approved by Sprint. CLEC may submit subsequent Attachment Requests as needed. CLEC shall have fourteen (14) calendar days after Sprint's return of the approved Attachment Request to CLEC to execute the Attachment Request and return the same to Sprint. If CLEC does not return the Attachment Request within the fourteen (14) calendar day interval specified above, then such request shall be null and void and such ROW shall become immediately available to other parties. The approved Attachment Request shall serve as the binding attachment contract between the parties.

3.3.3 Together with Sprint's notice of approval of an Attachment Request submitted by CLEC, Sprint shall also provide an estimate of the Make Ready Work costs associated with making the space available for CLEC's Attachment. Sprint shall complete any Make Ready Work required to enable CLEC to install its facilities at both a reasonable cost and within a reasonable time, both of which shall be agreed upon by Sprint and CLEC. If such agreement does not occur within ten (10) calendar days of Sprint's provision of a quote for such work or CLEC determines the quote is too high, CLEC may complete Make Ready Work on its own or hire outside contractors to do the work at CLEC's expense. Any contractors

hired by CLEC pursuant to this Section 3 shall meet Sprint's reasonable standards, which shall not exceed the equivalent personnel qualifications of Sprint personnel performing the same task. Sprint shall provide a security escort for CLEC and CLEC contractor and CLEC shall pay for such escort based on an hourly rate. Where CLEC submits an Attachment Request and subsequently fails to return an executed Attachment Request within fourteen calendar (14) days of Sprint's notice of approval, CLEC shall reimburse Sprint for its reasonable cost to provide pre-ordering information and any site survey work and the Attachment Request shall become null and void. Upon acceptance of an approved Attachment Request by CLEC and its return to Sprint, Sprint shall bill CLEC for any Make Ready Work non-recurring charges, if Sprint is to perform the Make Ready Work. Upon completion of any required Make Ready Work by Sprint or upon receipt of the approved Application Request by Sprint, whichever is later, written notice shall be provided to CLEC granting access to the ROW and advising CLEC of the date that monthly billing for such ROW shall commence. CLEC shall have one hundred eighty (180) calendar days to begin attachment and/or installation of its facilities after receipt of such notice. Any such construction shall be completed by the end of three hundred sixty-five (365) calendar days after receipt of such notice, unless CLEC notifies Sprint differently and Sprint agrees to such delay. CLEC notification to Sprint shall be provided at least sixty (60) calendar days prior to the expiration of the three hundred sixty-five (365) calendar day period. If CLEC does not begin construction within this time frame, Sprint will cease monthly billing to CLEC and the access to the ROW and the Attachment Request shall be deemed null and void.

3.3.4 Sprint shall make space available to CLEC as soon as any Make Ready Work to be provided by Sprint, as described in Section 3.3.3, is completed. At that time, CLEC shall have the right, subject to the terms and conditions of this Agreement, to place and maintain the facilities described in the Attachment Request in the space designated on or in Sprint's Poles, ducts, conduits, and other ROW identified therein. CLEC may, at its option, use CLEC or CLEC-designated personnel, which CLEC shall identify to Sprint prior to beginning construction, to attach its equipment to Sprint structures, subject to Sprint's agreement with the proposed construction methods proposed by CLEC to perform such work. Sprint shall provide a security escort to accompany CLEC or its contractors and CLEC shall pay for same based on an hourly rate. Any such approval shall not be unreasonably withheld,

delayed or denied. Sprint may require dismissal of the CLEC or CLEC-designated personnel in the event Sprint reasonably believes such personnel are not properly performing construction hereunder.

3.3.5 If Sprint performs the Make Ready Work specified by Section 3.3.3, CLEC agrees to pay Sprint the Make Ready Work costs within sixty (60) business days of receiving Sprint's invoice.

3.3.6 Sprint will provide CLEC with answers to an environmental, health and safety questionnaire for each Sprint facility in or on which CLEC seeks an Attachment. CLEC may provide this questionnaire with its Attachment Request and Sprint shall return it to CLEC with the approval of CLEC's Attachment Request.

3.4 Authority to Place Attachments

3.4.1 Before CLEC places any Attachment pursuant to an approved Attachment Request, CLEC shall submit evidence of its authority to erect and maintain the facilities to be placed on Sprint's facilities within the public streets, highways and other thoroughfares or on private property, where such additional authority is required by law. CLEC shall be solely responsible for obtaining all necessary licenses, authorizations, permits, and consents from federal, state and municipal authorities that may be required to place Attachments on Sprint's facilities.

3.4.2 Sprint shall not unreasonably intervene against or attempt to delay the granting of any necessary licenses, authorizations, permits or consents from federal, state and municipal authorities or private property owners that may be required for CLEC to place its Attachments on or in any Poles, ducts, conduits, or other ROW that Sprint owns or controls.

3.4.3 If any license, authorization, permit or consent obtained by CLEC is subsequently revoked or denied for any reason, permission to attach to Sprint's facilities shall terminate immediately and CLEC shall remove its Attachments (if any) within one hundred twenty (120) calendar days. CLEC may, at its option, litigate or appeal any such revocation or denial and if CLEC is diligently pursuing such litigation or appeal, CLEC may continue to maintain its Attachment. In doing so, CLEC agrees to indemnify Sprint from and against any and all costs resulting from Sprint's continuation of the Attachment which is the subject of such litigation or appeal.

3.5 Capacity

3.5.1 When there is insufficient space on a Pole or in a Sprint conduit to accommodate an CLEC-requested Attachment or occupancy, Sprint shall, at CLEC's option: (1) replace the Pole or conduit with one of greater height or capacity; (2) permit CLEC to replace the Pole or conduit with a Sprint-furnished Pole or conduit of greater height or capacity; or (3) place additional Poles or conduits in the ROW. CLEC shall be obligated to reimburse Sprint for its proportionate share of the actual costs incurred.

3.5.2 Sprint shall permit CLEC to break out of Sprint conduit and to maintain facilities within conduit space used by CLEC. Where required by Sprint, shall provide CLEC designated personnel with one escort and CLEC shall pay for such escort based on an hourly rate as specified in Sprint-Florida, Incorporated's Access Service Tariff. Such escort service shall be available twenty-four (24) hours per day each day of the week.

3.5.3 Sprint shall permit manhole interconnections and breaking out of Sprint manholes and shall provide CLEC with sufficient space in manholes for the racking and storage of cable and other materials as requested by CLEC. Sprint reserves the right to deny nonstandard requests to break out of manholes where the location in which CLEC wants to break out is blocked by a cable rack.

3.5.4 Sprint shall take all reasonable measures to allow access and/or egress to all conduit systems. This shall include but not be limited to Sprint's removal, upon CLEC's request, of any retired cable for conduit systems to allow for the efficient use of conduit space within a reasonable period of time. If the parties are unable to agree on what is reasonable (in terms of measures or time intervals), the matter may be submitted in accordance with the Dispute Resolution Procedures, described in Part A of this Agreement, by either party.

3.5.5 Where a spare inner duct does not exist, Sprint shall allow installation of an inner duct in a spare Sprint conduit. The procedure set forth in Section 3.3.3 shall govern such installation.

3.5.6 Neither party shall attach, or permit other entities to attach facilities on existing facilities of the other without the other party's prior written consent. Such consent will not be unreasonably

withheld if the requested use is to facilitate use of the ROW by Sprint or any other party on a temporary basis until such reasonable time as the ROW can be expanded.

3.5.7 CLEC acknowledges that, from time to time, it may be necessary or desirable for Sprint to change out Poles, relocate, reconstruct, or modify portions of its conduit system or rearrange facilities contained therein or connected thereto and that such changes may be necessitated by Sprint's business needs or by factors outside of Sprint's control, such as the decision by a municipality to widen streets or authorized application of another entity seeking access to Sprint's Poles or conduit systems. CLEC agrees that CLEC will, upon Sprint's request and at Sprint's expense, but at no cost to CLEC so long as no additional cost is incurred by Sprint as a result of CLEC being attached, participate with Sprint (and other licensees) in the relocation, reconstruction, or modification of Sprint's conduit system or facilities rearrangement.

3.6 Sharing of Right of Way

3.6.1 Sprint shall offer the use of such ROW it has obtained from a third party to CLEC, to the extent that Sprint's agreement with the third party explicitly permits Sprint to grant such rights to CLEC. If said third party agreement does not explicitly permit Sprint to grant such rights to CLEC, Sprint will, upon CLEC's request, grant said rights to CLEC provided that CLEC agrees, in writing, to indemnify, defend and hold Sprint harmless from and against any loss, cost, claim, liability, damage and expense (including reasonable attorney fees) to third parties relating to or arising out of the grant of such right of use to CLEC. In the event of a third party claim for loss, cost, claim, liability, damage or expense, Sprint agrees to use its best efforts to secure rights for CLEC in connection with the resolution of said claim. Sprint agrees to cooperate with CLEC in connection with the resolution of a claim hereunder.

3.7 Emergency Situations

3.7.1 Within fifteen (15) business days after the Approval Date, Sprint and CLEC shall mutually agree on a non-discriminatory priority method to access Sprint manholes and conduits in emergency situations.

3.8 Attachment Fees

3.8.1 CLEC shall pay Sprint an Attachment fee consistent with the Act, the FCC's implementing rules and regulations promulgated thereunder, and/or any relevant state commission order, for each Sprint facility upon which CLEC obtains authorization to place an Attachment. The parties agree that any new FCC rules and regulations setting forth a new methodology for determining the Attachment fee shall govern the establishment of the pricing of Attachments.

3.8.2 Sprint shall maintain an inventory of the Sprint facilities occupied by CLEC based upon the cumulative facilities specified in all Attachment Requests approved in accordance with Section 3.3. CLEC shall provide Sprint with "as built" drawing after each Attachment is completed. CLEC shall have the right to remove any Attachment at any time, and it shall be CLEC's sole responsibility to notify Sprint of any and all removals by CLEC of its Attachments from Sprint's facilities. Such notice shall be provided to Sprint at least thirty (30) calendar days prior to the removal of the Attachment and shall take the form of a notice of removal. CLEC shall remain liable for an Attachment fee for each Sprint facility included in all approved Attachment Requests until a notice of removal has been received by Sprint or CLEC cancels an Attachment pursuant to Section 3.13. Sprint may, at its option, conduct a physical inventory of the Attachments for purposes of determining the Attachment fees to be paid by CLEC under this Section 3.

3.9 Additions and Modifications to Existing Attachments

3.9.1 CLEC shall not modify, add to or replace facilities on any pre-existing Attachment without first notifying Sprint in writing of the intended modification, addition or replacement at least thirty (30) calendar days prior to the date the activity is scheduled to begin. The required notification shall include: (1) identification of the impacted Attachment, (2) the date the activity is scheduled to begin, (3) a description of the planned modification, addition or replacement, (4) a representation that the modification, addition or replacement will not require any space other than the space previously designated for CLEC's Attachments, and (5) a representation the modification, addition or replacement will not impair the structural integrity of the facilities involved.

3.9.2 If the modification, addition or replacement specified by CLEC in its notice will require more space than that currently allocated to CLEC or will require the reinforcement of replacement of or an addition of support equipment to the facilities involved in order to accommodate CLEC's modification, addition or replacement, CLEC will submit an Attachment Request in compliance with Section 3.3 in order to obtain authorization for the modification, addition or replacement of its facilities.

3.10 Noncompliance

3.10.1 If, at any time, Sprint determines that CLEC's facilities or any part thereof have not been placed or maintained or are not being used in accordance with the requirements of this Section 3, Sprint may send written notice to CLEC specifying the alleged noncompliance. If CLEC does not dispute Sprint's assertion in writing within thirty (30) calendar days of receipt thereof, CLEC will, within sixty (60) calendar days of receipt of the notice of noncompliance, provide Sprint with a schedule for bringing CLEC's facilities into compliance (which schedule shall be subject to Sprint's agreement, which agreement shall not be unreasonably withheld) and shall bring such facilities into compliance within the time periods specified in such schedule.

3.10.2 If CLEC disputes Sprint's assertion of noncompliance, CLEC shall notify Sprint of the basis of CLEC's belief that CLEC's facilities are compliant. If the parties are unable to agree on whether a noncompliance exists within thirty (30) calendar days of receipt of the noncompliance notice by CLEC, then the issue shall be resolved pursuant to the Dispute Resolution Procedures set forth in Part A of this Agreement.

3.11 Surveys and Inspections of Attachments

3.11.1 The exact location of Attachments on or in Sprint's facilities may be determined through a survey (at Sprint's expense) to be made not more than once per calendar year by Sprint. If so requested, CLEC and/or any other entity owning or jointly owning the facilities with Sprint may participate in the survey.

3.11.2 Apart from surveys conducted in accordance with Section 3.11.1 above, Sprint shall have the right to inspect (at Sprint's expense) any Attachment on or in Sprint's facilities as conditions may warrant upon written notice to CLEC. No joint survey or inspection by Sprint shall operate to relieve CLEC of any responsibility, obligation or liability assumed under this Agreement.

3.12 Notice of Modification or Alteration of Poles, Ducts, Conduits, or Other ROW by Sprint

3.12.1 If Sprint plans to modify or alter any Sprint facilities upon which CLEC has Attachments, Sprint shall provide CLEC notice of the proposed modification or alteration at least sixty (60) calendar days prior to the time the proposed modification or alteration is scheduled to take place. If CLEC decides not to modify or add to its existing Attachment, CLEC shall participate at no cost in such modification and rearrangement. If CLEC adds to or modifies its facilities CLEC shall be charged its proportionate share of the reasonable costs incurred by Sprint for such modification or rearrangement. CLEC shall make all rearrangements of its facilities within such period of time, which shall not be less than sixty (60) calendar days, as is jointly determined to be reasonable by the parties based on the amount of rearrangements necessary and a desire to minimize chances for service interruption or facility-based service denial to an CLEC customer.

3.13 Termination of Section 3 or An Individual Attachment by CLEC

3.13.1 This Section 3 may be terminated by CLEC any time prior to the expiration of its term by providing written notice to Sprint of its intent to terminate not less than ninety (90) calendar days prior to the date such termination is to become effective. Upon removal of such attachment, all fees for such attachment shall cease. Within one hundred twenty (120) calendar days after the date this Section 3 is terminated, CLEC shall cause all of its Attachments to be removed from all of Sprint's Poles. In the event CLEC fails to remove its Attachments as required by this Section 3, Sprint shall have the option to remove all such Attachments and store them in a public warehouse or elsewhere at the expense of and for the account of CLEC without Sprint being deemed guilty of trespass or conversion, and without Sprint becoming liable for any loss or damages to CLEC occasioned thereby.

3.13.2 Sprint may terminate, at any time, an Attachment under this Agreement upon thirty (30) calendar days in connection with any taking or condemnation of property on which such Attachment is located by a competent authority for any public use or purpose.

3.14 Abandonment

3.14.1 Nothing in this Agreement shall prevent or be construed to prevent Sprint from abandoning, selling, assigning or otherwise disposing of any Poles, conduit systems, or other Sprint property used for Attachments, provided, however, that Sprint shall condition any such sale, assignment or other disposition subject to the rights granted to CLEC pursuant to this Agreement. Sprint shall promptly notify CLEC of any proposed sale, assignment or other disposition of any facilities or other Sprint property used for CLEC's Attachments.

3.15 Dispute Resolution Procedures

3.15.1 If either party has declared the other in default of any provisions of this Attachment VI , or has otherwise notified the other party that it is not in compliance with the terms of this Section 3, either party may invoke the Dispute Resolution Procedures, described in Part A of this Agreement, or the procedures described in the Act, the *FCC's First Interconnection Order*, §1217-1231 and the FCC's Rules at 47 CFR § 1.1401-1.1416. In the event either party invokes the Dispute Resolution Procedures as provided herein, Sprint will continue to process Attachment Requests pursuant to this Section 3.

3.15.2 Sprint will not be relieved of its obligations to process Attachment Requests by CLEC if CLEC is alleged to be in default of this Section 3 for nonpayment of fees and charges due Sprint under this Section 3, so long as such default is (1) the subject of Dispute Resolution Procedures as set forth in Part A of this Agreement; or (2) being adjudicated before the FCC or any other court, regulatory body, agency, or tribunal having jurisdiction over such dispute.

PART C - ATTACHMENT VII

INTERIM NUMBER PORTABILITY

Section 1. Sprint Provision of Interim Number Portability

Sprint shall provide interim number portability in accordance with requirements of the Act and FCC Rules and Regulations. INP shall be provided with minimum impairment of functionality, quality, reliability and convenience to subscribers of CLEC services.

Section 2. Interim Number Portability (INP)

INP shall be provided to the extent technical capabilities allow, by Remote Call Forwarding ("RCF") or Direct Inward Dialing (DID).

2.1 Remote Call Forwarding: Remote Call Forwarding (RCF) is an INP method to provide subscribers with service-provider portability by redirecting calls within the telephone network. When RCF is used to provide interim number portability, calls to the ported number will first route to the Sprint switch to which the ported number was previously assigned. The Sprint switch will then forward the call to a number associated with the CLEC designated switch to which the number is ported. CLEC may order any additional paths to handle multiple simultaneous calls to the same ported telephone number.

2.2 DID is an INP method that makes use of direct inward dialing trunks. Each DID trunk group used for INP is dedicated to carrying FLEX-DID INP traffic between the Sprint end office and the CLEC switch. Traffic on these trunks cannot overflow to other trunks, so the number of trunks shall be conservatively engineered by Sprint. Also, inter-switch signaling is usually limited to multi-frequency (MF). This precludes passing CLID to the CLEC switch.

2.3. The trunking requirements will be agreed upon by Sprint and CLEC resultant from application of sound engineering principles. These trunking options may include SS7 signaling, inband signaling, and may be one way or two way. The trunks used may be the same as those used for exchange of other Local Traffic and toll traffic between Sprint and CLEC.

2.4 LERG Reassignment

2.4.1 Portability for an entire NXX shall be provided by utilizing reassignment of the block to CLEC through the Local Exchange Routing Guide (LERG). Updates to translations in the Sprint switching office from which the telephone number is ported will be made by Sprint prior to the date on which LERG changes become effective, in order to redirect calls to the CLEC switch via route indexing.

2.5 Other Currently Available Number Portability Provisions

2.5.1 Where SS7 is available, Sprint shall exchange with CLEC, SS7 TCAP messages as required for the implementation of Custom Local Area Signaling Services (CLASS) or other features available in the Sprint network, if technically feasible.

2.5.2 Upon notification that CLEC will be initiating INP, Sprint shall disclose to CLEC any technical or capacity limitations that would prevent use of the requested INP in the affected switching office. Sprint and CLEC shall cooperate in the process of porting numbers to minimize subscriber out-of-service time, including updating switch translations where necessary within five (5) minutes after notification that physical cut-over has been completed (or initiated), as CLEC may designate.

2.5.3 For INP, CLEC shall have the right to use the existing Sprint 911 infrastructure for all 911 capabilities. When RCF is used for CLEC subscribers, both the ported numbers and shadow numbers shall be stored in ALI databases. CLEC shall have the right to verify the accuracy of the information in the ALI databases.

2.5.4 When any INP method is used to port a subscriber, the donor provider must maintain the Line Information Database (LIDB) record for that number to reflect appropriate conditions as reported to it by the porting service provider. The donor must outclear call records to CLEC for billing and collection from the subscriber. Until such time as Sprint's LIDB has the software capability to recognize a ported number as CLEC's, Sprint shall store the ported number in its LIDB at no charge and shall retain revenue for LIDB look-ups to the ported number. At such time as Sprint's LIDB has the software capability to recognize that the ported number is CLEC's then, if CLEC desires to store numbers on Sprint's LIDB, the parties shall negotiate a separate LIDB database storage and look-up agreement.

2.5.5 Sprint should send a CARE transaction 2231 to notify IXC that access is now provided by a new CLEC for that number.

Section 3. Requirements for INP

3.1 Cut-Over Process

3.1.1 Sprint and CLEC shall cooperate in the process of porting numbers from one carrier to another so as to limit service outage for the ported subscriber.

3.1.1.1 For a Coordinated Cutover Environment, Sprint shall verbally coordinate with CLEC the disconnect and switch translations as close to the requested time as possible. The coordination shall be pre-specified by CLEC and agreed to by both parties and in no case shall begin more than 30 minutes after the agreed upon time.

3.1.1.2 For a Non-Coordinated Cutover Environment, Sprint shall schedule a mechanized update of disconnect and switch translations at the CLEC requested cutover time. Such updates will be available to CLEC at Parity with Sprint's own availability for such activity. Sprint shall provide an operations contact whom CLEC can reach in the event manual intervention is needed to complete the cutover. In the event of manual intervention, and if Sprint is unable to resolve the issue within sixty (60) minutes, Sprint shall notify CLEC of the issue and CLEC and Sprint shall determine the plan to resolve it.

3.2 Testing

Sprint and CLEC shall cooperate in conducting CLEC's testing to ensure interconnectivity between systems. Sprint shall inform CLEC of any system updates that may affect the CLEC network and Sprint shall, at CLEC's request, perform tests to validate the operation of the network. Additional testing requirements may apply as specified by this Agreement.

3.3 Installation Timeframes

3.3.1 Installation Time Frames for RCF ILNP where no other work is required, will be as follows:

3.3.1.1 Business Lines and Trunks:

3.3.1.1.1 After the FOC date has been established:
Orders of 1-20 lines in three (3) business days;
Orders of 21-40 lines in seven (7) business days;
Orders of 41-60 lines in twelve (12) business days;
Orders with 61 lines and greater will have an installation timeframe mutually agreed upon by Sprint and CLEC.

3.3.1.2 Residential Lines:

3.3.1.2.1 Within two (2) business days of Service Order Receipt by Sprint.

3.3.2 If a subscriber elects to move its Telephone Exchange Service back to Sprint while on an INP arrangement, Sprint shall notify CLEC of the Subscriber's termination of service with CLEC and the Subscriber's instructions regarding its telephone number(s) within two (2) business days of receiving notification from the Subscriber.

3.4 Call Referral Announcements

3.4.1 Sprint shall allow CLEC to order all referral announcements, and specify the particular announcement from Sprint's standard set of call referral announcement options, on a per telephone number basis, for telephone numbers which CLEC has ported from Sprint to CLEC and for which INP measures have, at CLEC's direction, been terminated.

3.5 Engineering and Maintenance

Sprint and CLEC will cooperate to ensure that performance of trunking and signaling capacity is engineered and managed at levels which are at Parity with that provided by Sprint to its subscribers and to ensure effective maintenance testing through activities such as routine testing practices, network trouble isolation processes and review of operational elements for translations, routing and network fault isolation.

3.6 Operator Services and Directory Assistance

With respect to operator services and directory assistance associated with INP for CLEC subscribers, Sprint shall provide the following:

3.6.1 While INP is deployed :

3.6.1.1 Sprint shall allow CLEC to order provisioning of Telephone Line Number (TLN) calling cards and Billed Number Screening (BNS), in its LIDB, for ported numbers, as specified by CLEC. Sprint shall continue to allow CLEC access to its LIDB. Other LIDB provisions are specified in this Agreement.

3.6.1.2 Where Sprint has control of directory listings for NXX codes containing ported numbers, Sprint shall maintain entries for ported numbers as specified by CLEC.

3.6.2 Sprint shall provide a 10-Digit Global Title Translation (GTT) Node for routing queries for TCAP-based operator services (e.g., LIDB).

3.6.3 Sprint OSS shall meet all requirements specified in "Generic Operator Services Switching Requirements for Number Portability," Issue 1.00, Final Draft, April 12, 1996. Editor - Nortel.

3.7 Number Reservation

3.7.1 When a subscriber ports to another service provider and has previously secured, via a tariffed offering, a reservation of line numbers from the donor provider for possible activation at some future point, these reserved but inactive numbers shall "port" along with the active numbers being ported by the subscriber in order to ensure that the end user subscriber will be permitted to expand its service using the same number range it could use if it remained with the donor provider.

PART C - ATTACHMENT VIII

GENERAL BUSINESS REQUIREMENTS

Section 1. General Business Requirements

1.1 Procedures

1.1.1 Contact with Subscribers

1.1.1.1 Each Party at all times shall be the primary contact and account control for all interactions with its subscribers, except as specified by that Party. Subscribers include active subscribers as well as those for whom service orders are pending.

1.1.1.2 Each Party shall ensure that any of its personnel who may receive inquiries from the other Party's subscriber regarding the other service provided by the other Party to said subscriber or who may otherwise have opportunity for contact with the other Party's subscriber shall: (i) provide appropriate referrals to and telephone numbers of the other Party to the subscriber making such inquiries; (ii) do not in any way disparage or discriminate against the other Party, or its product or services; and (iii) do not provide information about such Party's own products or services during that same inquiry or subscriber contact.

1.1.1.3 Sprint shall not use CLEC's request for subscriber information, order submission, or any other aspect of CLEC's processes or services to aid Sprint's marketing or sales efforts.

1.1.2 Expedite, Escalation, and Disaster Procedures

1.1.2.1 No later than thirty (30) days after the Effective Date of this Agreement, Sprint and CLEC shall develop mutually acceptable escalation and expedite procedures which may be invoked at any point in the Service Ordering, Provisioning, Maintenance, and Subscriber Usage Data transfer processes to facilitate rapid and timely resolution of disputes. In addition, Sprint and CLEC will establish intercompany contacts lists for purposes of handling

subscriber and other matters which require attention/resolution outside of normal business procedures within thirty (30) days after the Effective Date of this Agreement. Each party shall notify the other party of any changes to its escalation contact list at least one (1) week before such changes are effective.

1.1.2.2 No later than thirty (30) days after the Effective Date of this Agreement, Sprint shall provide CLEC with contingency plans for those cases in which normal Service Ordering, Provisioning, Maintenance, Billing, and other procedures for Sprint's unbundled Network Elements, features, functions, and resale services are inoperable.

1.1.3 Subscriber of Record

1.1.3.1 Sprint shall recognize CLEC as the Subscriber of Record for all Network Elements or services for resale ordered by CLEC and shall send all notices, invoices, and information which pertain to such ordered services directly to CLEC. CLEC will provide Sprint with addresses to which Sprint shall send all such notices, invoices, and information.

1.2 Service Offerings

1.2.1 Sprint shall provide CLEC with access to new services, features and functions concurrent with Sprint's notice to CLEC of such changes, if such service, feature or function is installed and available in the network or as soon thereafter as it is installed and available in the network, so that CLEC may conduct market testing.

1.2.2 Essential Services

1.2.2.1 For purposes of service restoral, Sprint shall designate a CLEC access line as an Essential Service Line (ESL) at Parity with Sprint's treatment of its own subscribers and applicable state law or regulation, if any.

1.2.3 TTY/TDD

1.2.3.1 Sprint shall cooperate with CLEC to provide Telecommunications Services at Parity to serve TTY/TDD subscribers.

1.2.4 Blocking Services

Upon request from CLEC, Sprint shall provide blocking of 700, 900, and 976 services, or other services of similar type as may now exist or be developed in the future, and shall provide Billed Number Screening (BNS), including required LIDB updates, or equivalent service for blocking completion of bill-to-third party and collect calls, on a line, PBX, or individual service basis. Blocking shall be provided the extent (a) it is an available option for the Telecommunications Service resold by CLEC, or (b) it is technically feasible when requested by CLEC as a function of unbundled Network Elements.

1.2.5 Training Support

1.2.5.1 Sprint shall provide training, on a non-discriminatory basis, for all Sprint employees who may communicate, either by telephone or face-to-face, with CLEC subscribers. Such training shall include compliance with the branding requirements of this Agreement including without limitation provisions of forms, business cards and "Not at Home" notices.

1.2.5.2 Sprint shall train CLEC employees at a Sprint location on any Sprint-owned or Sprint-developed systems and processes non-industry standard and which need to be used by CLEC's employees or agent to carry out this Agreement and shall provide the same information available to Sprint employees. Sprint shall provide training to up to two (2) CLEC employees, including all necessary updates to such training, at no charge. CLEC will bear any and all expenses incurred by or on behalf of such employees in connection with attendance at such training sessions.

1.2.6 Carrier Identification Codes

Sprint shall provide to CLEC the active Codes (CIC) for both Dial 1 and 800 services for each of its access Tandems and shall provide updates promptly as those codes change from time to time.

Section 2. Ordering and Provisioning

2.1 General Business Requirements

2.1.1 Ordering and Provisioning Parity

2.1.1.1 Sprint shall provide necessary ordering and provisioning business process support as well as those technical and systems interfaces as may be required to enable CLEC to provide the same level and quality of service for all resale services, functions, features, capabilities and unbundled Network Elements at Parity.

2.1.2 Local Carrier Service Center (LCSC)/Single Point of Contact (SPOC)

2.1.2.1 Sprint shall provide a Local Carrier Service Center or equivalent which shall serve as CLEC's Single Point of Contact (SPOC) for all activities involved in the ordering and provisioning of Sprint's unbundled Network Elements, features, functions, and resale services. CLEC shall have the ability to submit orders twenty-four (24) hours a day seven (7) days a week.

2.1.2.2 The SPOC shall provide to CLEC a nationwide telephone number (available from 6:00 a.m. to 8:00 p.m. Eastern Standard Time, Monday through Friday, and 8:00 am through 5:00 P.M. Eastern Standard Time on Saturday) answered by competent, knowledgeable personnel and trained to answer questions and resolve problems in connection with the ordering and provisioning of unbundled Network Elements (except those associated with local trunking interconnection), features, functions, capabilities, and resale services.

2.1.2.3 Sprint shall provide, as requested by CLEC, through the SPOC, provisioning and premises visit installation support in the form of coordinated scheduling, status, and dispatch capabilities during Sprint's standard business hours and at other times as agreed upon by the parties to meet subscriber demand.

2.1.2.4 SPOC shall fax a form, "Notification to CLEC of Change in End User", to the CLEC, within (24) hours from SPOC's receipt of disconnection notice of CLEC's customer.

2.1.3 Street Address Guide (SAG)

2.1.3.1 Within thirty (30) days after the Effective Date of this Agreement or as otherwise mutually agreed, Sprint shall provide to CLEC the SAG data, or its equivalent, in an electronic format mutually agreeable to the parties. All changes and updates to the SAG shall be provided to in a mutually agreed format and timeframe.

2.1.4 CLASS and Custom Features

2.1.4.1 CLEC may order the entire set of CLASS, CENTREX and Custom features and functions, or a subset of any one of such features.

2.1.5 Number Administration/Number Reservation

2.1.5.1 Sprint shall provide testing and loading of CLEC's NXX on the same basis as Sprint provides itself or its affiliates. Further, Sprint shall provide CLEC with access to abbreviated dialing codes, access arrangements for 555 line numbers, and the ability to obtain telephone numbers, including vanity numbers, while a subscriber is on the phone with CLEC. Sprint shall provide the same range of number choices to CLEC, including choice of exchange number, as Sprint provides its own subscribers. Reservation and aging of numbers shall remain Sprint's responsibility.

2.1.5.2 Where mutually agreed, which agreement shall not be unreasonably withheld, the Parties will implement LERG reassignment for particular NXX Codes.

2.1.5.3 In conjunction with an order for service, Sprint shall accept CLEC orders for vanity numbers and blocks of numbers for use with complex services including, but not limited to, DID, CENTREX, and Hunting arrangements, as requested by CLEC.

2.1.5.4 For simple services number reservations and aging of Sprint's numbers, Sprint shall provide real-time confirmation of the number reservation. For number reservations associated with complex services, Sprint shall provide confirmation of the number reservation within twenty-four (24) hours of CLEC's request. Consistent with the manner in which Sprint provides numbers to its own

subscribers, no telephone number assignment is guaranteed until service has been installed.

2.2 Service Order Process Requirements

2.2.1 Service Migrations and New Subscriber Additions

2.2.1.1 For resale services, Sprint shall not disconnect any subscriber service or existing features at any time during the migration of that subscriber to CLEC service without prior CLEC agreement.

2.2.1.2 For services provided through unbundled Network Elements, Sprint shall recognize CLEC as an agent, in accordance with OBF developed processes, for the subscriber in coordinating the disconnection of services provided by another CLEC or Sprint. In addition, Sprint and CLEC will work cooperatively to ensure that a subscriber is not disconnected from service during these conversions.

2.2.1.3 Unless otherwise directed by CLEC and when technically capable, when CLEC orders resale services or Network Elements all trunk or telephone numbers currently associated with existing services shall be retained without loss of feature capability and without loss of associated ancillary services including, but not limited to, Directory Assistance and 911/E911 capability.

2.2.1.4 For subscriber conversions requiring coordinated cut-over activities, on a per order basis, Sprint and CLEC will agree on a scheduled conversion time, which will be a designated two (2) hour time period within a designated date.

2.2.1.4.1 Any request made by CLEC to coordinate conversions after normal working hours, or on Saturday or Sunday or legal holidays shall be performed at CLEC's expense.

2.2.1.5 End user service interruptions shall be held to a minimum, and in any event shall not exceed the time Sprint experiences when performing such work for its own subscribers.

6.1.2.3.8.3 Upon CLEC's request, call completion to the requested number for local and intraLATA toll calls shall be sent to the network specified by CLEC where such call completion routing is technically feasible. If fulfillment of such routing request is not technically feasible, Sprint shall promptly notify CLEC if and when such routing becomes technically feasible. Rating and billing responsibility shall be agreed to by CLEC and Sprint.

6.1.2.3.8.4 Populate the Directory Assistance database in the same manner and in the same time frame as for Sprint subscribers.

6.1.2.3.8.5 Any information provided by a Directory Assistance Automatic Response Unit (ARU) shall be repeated the same number of times for CLEC subscribers as for Sprint's subscribers.

6.1.2.4 Sprint shall provide CLEC call detail records in a mutually agreed format and manner.

6.1.3 Operator Services

6.1.3.1 Sprint shall provide for the routing of local operator services calls (including but not limited to 0+, 0-) dialed by CLEC subscribers directly to either the CLEC operator service platform or Sprint operator service platform to the extent Sprint's switch can perform this customized routing, as specified by CLEC.

6.1.3.2 CLEC subscribers shall be provided the capability by Sprint to dial the same telephone numbers to access CLEC operator service that Sprint subscribers dial to access Sprint operator service.

6.1.3.3 Sprint shall provide Operator Services to as described below until, at CLEC's discretion, Sprint routes calls to the CLEC Local Operator Services platform.

2.2.1.6 A general Letter of Agency ("LOA") initiated by CLEC or Sprint will be required to process a PLC or PIC change order. Providing the LOA, or a copy of the LOA, signed by the end user will not be required to process a PLC or PIC change ordered by CLEC or Sprint. CLEC and Sprint agree that PLC and PIC change orders will be supported with appropriate documentation and verification as required by FCC and Commission rules. In the event of a subscriber complaint of an unauthorized PLC record change where the Party that ordered such change is unable to produce appropriate documentation and verification as required by FCC and Commission rules (or, if there are no rules applicable to PLC record changes, then such rules as are applicable to changes in long distance carriers of record), such Party shall be liable to pay and shall pay all nonrecurring charges associated with reestablishing the subscriber's local service with the original local carrier. Should Sprint fail to change a subscriber to CLEC pursuant to the terms of this Agreement, and upon notice by CLEC to Sprint that such a failure occurred, then Sprint shall immediately change the subscriber to CLEC and shall waive all non-recurring charges normally associated with such a change. Should CLEC fail to change a subscriber to Sprint pursuant to the terms of this Agreement, and upon notice by Sprint to CLEC that such failure occurred, then CLEC shall immediately change the subscriber to Sprint and shall waive all non-recurring charges normally associated with such a change. Sprint will notify CLEC when conversion is complete.

2.2.2 Intercept Treatment and Transfer Service Announcements

2.2.2.1 Sprint shall provide unbranded intercept treatment and transfer of service announcements to CLEC's subscribers. Sprint shall provide such treatment and transfer of service announcement in accordance with local tariffs and as provided to similarly situated Sprint subscribers for all service disconnects, suspensions, or transfers.

2.2.3 Due Date

2.2.3.1 Sprint shall supply CLEC with due date intervals to be used by CLEC personnel to determine service installation dates.

2.2.3.2 Sprint shall use best efforts to complete orders by the CLEC requested DDD within agreed upon intervals and performance measures.

2.2.3.3 CLEC shall specify on each order the Desired Due Date ("DDD"). Sprint shall not complete the order prior to the DDD, unless authorized by CLEC.

2.2.3.4 If the DDD falls after the agreed upon standard order completion interval, Sprint shall use the DDD as the order due date.

2.2.3.5 Subsequent to an initial order submission, CLEC may request a new/revised due date that is earlier than the minimum defined interval.

2.2.3.6 Any special or preferred scheduling options available, internally or externally to Sprint, for ordering and provisioning services shall also be available to CLEC.

2.2.4 Subscriber Premises Inspections and Installations

2.2.4.1 CLEC shall perform or contract for all CLEC's needs assessments, including equipment and installation requirements, at the subscriber premises.

2.2.4.2 Sprint shall provide CLEC with the ability to schedule subscriber premises installations. The parties shall mutually agree on an interim process to provide this functionality during the implementation planning process.

2.2.5 Firm Order Confirmation (FOC)

2.2.5.1 Sprint shall provide to CLEC, a Firm Order Confirmation (FOC) for each CLEC order. The FOC shall contain the appropriate data elements as defined by the OBF standards.

2.2.5.2 For a revised FOC, Sprint shall provide standard detail as defined by the OBF standards.

2.2.5.3 Sprint shall provide to CLEC the date that service is scheduled to be installed.

2.2.6 Order Rejections

2.2.6.1 Sprint shall reject and return to CLEC any order that Sprint cannot provision, due to technical reasons, missing information, or jeopardy conditions. When an order is rejected, Sprint shall, in its reject notification, specifically describe all of the reasons for which the order was rejected. Sprint shall not reject any orders on account of the Desired Due Date.

2.2.6.2 Sprint agrees to accept from Carrier verbal administrative errors. Sprint shall immediately inform Carrier by telephone of any minor issues which can be handled over the phone.

2.2.6.3 If any portion of a service order, as submitted by Carrier, is not correct, Sprint shall make all reasonable attempts to complete any portion of the work that can be completed, while awaiting correction of error conditions by Carrier.

2.2.7 Service Order Changes

2.2.7.1 If an installation or other CLEC ordered work requires a change from the original CLEC service order in any manner, Sprint shall call CLEC in advance of performing the installation or other work to obtain authorization. Sprint shall then provide CLEC an estimate of additional labor hours and/or materials. After all installation or other work is completed, Sprint shall promptly notify CLEC of costs.

2.2.7.1.1 If additional work is completed on a service order, as approved by CLEC, the cost of the additional work must be reported promptly to CLEC.

2.2.7.1.2 If a service order is partially completed, notification must identify the work that was done and work remaining to be completed.

2.2.7.2 If a CLEC subscriber requests a service change at the time of installation or other work being performed by Sprint on behalf of CLEC, Sprint, while at the subscriber premises, shall direct the CLEC subscriber to contact CLEC.

2.2.7.3 Sprint shall provide to CLEC notification of any jeopardy situations prior to the committed due date, missed appointments and any other delay or problem in completing work specified on CLEC's service order as detailed on the FOC, in accordance with agreed upon performance measurements.

2.2.8 Cooperative Testing

2.2.8.1 Testing

2.2.8.1.1 Sprint shall perform all its standard pre-service testing prior to the completion of the order.

2.2.8.1.2 Within 24 hours of CLEC's request for scheduled cooperative maintenance testing, Sprint shall perform said testing with CLEC (including trouble shooting to isolate any problems) to test Network Elements purchased by CLEC in order to identify any problems.

2.2.8.1.3 Sprint shall cooperate with CLEC upon request to ensure that all operational interfaces and processes are in place and *functioning properly and efficiently*, as mutually agreed by the Parties. Testing shall simulate actual operational procedures and systems interfaces to the greatest extent possible. Further, the testing shall not be limited by either geography or time frame, unless

otherwise mutually agreed by the Parties. CLEC may request cooperative testing to ensure service performance, reliability, and subscriber serviceability.

2.2.9 Service Suspensions/Restorations

2.2.9.1 Upon CLEC's request through an Industry Standard (OBF) Suspend/Restore Order, or mutually agreed upon interim procedure, Sprint shall suspend or restore the functionality of any Network Element, feature, function, or resale service to which suspend/restore is applicable. Sprint shall provide restoration priority on a per network element basis in a manner that conforms with any applicable regulatory Rules and Regulations or government requirements.

2.2.10 Order Completion Notification

2.2.10.1 Upon completion of the requests submitted by CLEC, Sprint shall provide to CLEC a completion notification in an industry standard (i.e. OBF) or in a mutually agreed format. The completion notification shall include detail of the work performed, to the extent this is defined within OBF guidelines, and in an interim method until such standards are defined.

2.2.11 Specific Unbundling Requirements

2.2.11.1 CLEC may order and Sprint shall provision unbundled Network Elements. However, it is CLEC's responsibility to combine the individual network elements should it desire to do so.

2.3 Systems Interfaces and Information Exchanges

2.3.1 General Requirements

2.3.1.1 Sprint shall provide to CLEC Electronic Interface(s) for transferring and receiving information and executing transactions for all business functions directly or indirectly related to Service Ordering and Provisioning of Network Elements, features, functions and Telecommunications

Service, as specified in this Section 2.3. The Interface(s) shall be developed/designed for the transmission of data from CLEC to Sprint, and from Sprint to CLEC.

2.3.1.2 Interim interfaces or processes may be modified, if so agreed by CLEC and Sprint, during the interim period.

2.3.1.3 Until the real-time, Electronic Interface is available, Sprint agrees that the Local Carrier Service Center (LCSC) or similar function will accept CLEC orders. Orders will be transmitted to the LCSC via an interface or method agreed upon by CLEC and Sprint.

2.3.2 For any CLEC subscriber Sprint shall provide, subject to applicable rules, orders, and decisions, CLEC with access to Customer Proprietary Network Information (CPNI) without requiring CLEC to produce a signed Letter of Agency (LOA), based on CLEC's blanket representation that subscriber has authorized CLEC to obtain such CPNI.

2.3.2.1 The preordering Electronic Interface includes the provisioning of Customer Proprietary Network Information (CPNI) information from Sprint to CLEC. The Parties agree to execute a Letter of Authorization (LOA) agreement prior to requesting CPNI for a Sprint end user, and to request end user CPNI only when the end user has specifically given permission to receive CPNI. The Parties agree that they will conform to FCC and/or state regulations regarding the provisioning of CPNI between the parties, and regarding the use of that information by the requesting party.

2.3.2.2 The requesting Party will document end user permission obtained to receive CPNI, whether or not the end user has agreed to change local service providers. For end users changing service from one party to the other, specific end user LOAs may be requested by the Party receiving CPNI requests to investigate possible slamming incidents, and for other reasons agreed to by the Parties. The receiving Party may also request documentation of an LOA if CPNI is requested and a subsequent service order for the change of local service is not received.

2.3.2.3 The Disclosing Party may perform a comparison of requests for CPNI to service orders received for the change of Local Service to the Requesting Party. The Disclosing Party will produce a report of unmatched requests for CPNI, and may require an LOA from the Requesting Party for each unmatched request. The Requesting Party agrees to provide evidence of end user permission for receipt of CPNI for all end users as requested by the Disclosing Party within three (3) business days of receipt of a request. Should the Disclosing Party determine that there has been a substantial percentage of unmatched LOA requests, the Disclosing Party reserves the right to immediately disconnect the preordering Electronic Interface.

2.3.2.4 If the Requesting Party is not able to provide the LOA for 95% assuming a minimum of fifty (50) applicable CPNI requests pursuant to 2.3.2.3. above of the end users requested by the Disclosing Party, or if the Disclosing Party determines that the LOA is inadequate, the Requesting Party will be considered in breach of the agreement. The Requesting Party can cure the breach by submitting to the Disclosing Party evidence of an LOA within ten (10) business days of notification of the breach.

2.3.2.5 Should the Requesting Party not be able to cure the breach in the timeframe noted above, the Disclosing Party will provide written notice to the Requesting Party that the Disclosing Party will disconnect the preordering Electronic Interface between the Parties. The Disclosing Party will provide its manual interim systems and procedures for the Requesting Party's use, which will not provide Parity of service to the Requesting Party. The Disclosing Party will suspend the calculation of the preordering service quality measures agreed to in Attachment 9 until, in the Disclosing Party's determination, the Requesting Party has corrected the problem that caused the breach.

2.3.2.6 Sprint will reconnect the preordering Electronic Interface upon Sprint's timely review and acceptance of evidence provided by CLEC to correct the problem that caused the breach.

2.3.2.7 Should Sprint disconnect the preordering Electronic Interface to CLEC three times in any twenty four (24) month period for breach of these preordering procedures, Sprint may permanently disconnect the preordering Electronic Interface, and/or may terminate the Interconnection Agreement in accordance with Part A herein.

2.3.2.8 If the Parties disagree as to the adequacy of evidence of and user permission supplied by one Party to the other, the Parties may immediately request dispute resolution in accordance with Section 22 of Part A. Sprint will not disconnect the preordering Electronic Interface during the Alternate Dispute Resolution process.

2.3.2.9 When available per Electronic Interface Implementation Plan, Sprint shall provide to CLEC Electronic Interface to Sprint information systems to allow CLEC to assign telephone number(s) (if the subscriber does not already have a telephone number or requests a change of telephone number) at Parity.

2.3.2.10 Upon Carrier's request, Sprint shall provide to Carrier, as soon as practicable, a list of all current service offerings by Switch location, which are Technically Feasible and available.

2.3.2.11 When available per Electronic Interface Implementation Plan, Sprint shall provide to CLEC a real-time, Electronic Interface to schedule dispatch and installation appointments at Parity.

2.3.2.12 When available per Electronic Interface Implementation Plan, Sprint shall provide to CLEC a real-time, Electronic Interface to Sprint subscriber information systems which will allow CLEC to determine if a service call is needed to install the line or service at Parity.

2.3.2.13 When available per Electronic Interface Implementation Plan, Sprint shall provide to CLEC a real-time, Electronic Interface to Sprint information systems which will allow CLEC to provide service availability dates at Parity.

2.3.2.14 When available per Electronic Interface Implementation Plan, Sprint shall provide to CLEC a real-

time, Electronic Interface which transmits status information on service orders at Parity. Until real-time Electronic Interface is available, Sprint agrees that Sprint will provide proactive status on service orders at the following critical intervals: acknowledgment, firm order confirmation, and completion according to interim procedures to be mutually developed.

2.4 Standards

2.4.1 General Requirements

2.4.1.1 CLEC and Sprint shall agree upon the appropriate ordering and provisioning codes to be used for Network Elements. These codes shall apply to all aspects of the unbundling of that element and shall be known as data elements as defined by the Telecommunications Industry Forum Electronic Data Interchange Service Order Subcommittee (TCIF-EDI-SOSC).

2.4.1.2 Sprint shall provide to Carrier as soon as practicable a listing of all technically available functionalities for Network Elements.

2.4.1.3 Sprint shall provide to Carrier upon request all engineering design and layout information for Network Elements where applicable.

2.4.1.4 When available per the electronic interface implementation plan, Sprint shall provide to Carrier a real-time, electronic interface which will allow Carrier to determine service due date intervals, schedule appointments, and adjust pending order due dates at Parity with that provided to similarly-situated Sprint subscribers.

2.4.1.5 To the extent Sprint has such information, Sprint shall provide to Carrier upon request advance information of the details and requirements for planning and implementation of NPA splits at least six (6) months prior to implementation of the split.

2.4.1.6 Sprint shall provide to Carrier information on charges associated with special construction. Until real-time, electronic interface is available, Sprint agrees that Sprint will promptly notify Carrier of any charges associated with necessary construction.

2.4.1.7 Sprint shall provide Carrier with results from routine mechanized loop tests for those instances when Sprint provides Local Switching and Carrier provides the Loop. Results of any non-routine testing requested by Carrier shall be provided at Carrier's expense.

2.4.2 Performance Measurements and Reporting

2.4.2.1 Cycle Time Measurements

2.4.2.1.1 Excepting expedited due date requests, the following order intervals shall constitute the basis for measuring Sprint service order performance under this Agreement. Carrier and Sprint may agree to modify such measurements from time to time.

2.4.2.1.2 Sprint will provide and acknowledge each and every Carrier service order within eight (8) working hours of receipt by Sprint.

2.4.2.1.3 Sprint shall process Carrier service orders and provide either Firm Order Confirmation ("FOC") of a correct service order or notification of a rejected order and the detail of the errors contained within any data element(s) fields contained in such order, within eight (8) working hours of receipt of Local Service Request ("LSR") from Carrier.

2.4.2.1.4 Sprint shall complete any Suspend/Restore order as required by Commission regulation or no more than eight (8) working hours after receipt by Sprint.

2.4.2.1.5 When Carrier specifies a DDD that is greater than the standard intervals defined in this Agreement, Sprint shall complete ordering and provisioning activities no earlier than that date.

2.4.2.1.6 For expedited due date requests, Sprint shall confirm to Carrier within eight (8) business hours after Sprint receipt of such request from Carrier whether Sprint can complete an initially submitted order within the expedited interval requested by Carrier. Confirmation may be provided by Sprint via a telephone call with follow-up confirmation to be provided by Sprint according to normal procedures and measurement intervals.

2.4.2.1.7 Subsequent to an order which has been initially submitted by Carrier, Carrier may require a new/revised due date that is earlier than the minimum defined interval.

2.4.2.1.8 For such requests, Sprint shall confirm to Carrier within eight (8) business hours after Sprint receipt of the revised due date request from Carrier whether Sprint can complete the order within the expedited interval requested by Carrier. Confirmation may be provided by Sprint via a telephone call with follow-up confirmation to be provided by Sprint according to normal procedures and measurement intervals.

2.4.2.1.9 Cycle time intervals for ordering and provisioning of all unbundled Network Elements, where facilities are available, shall be provided by Sprint to Carrier as part of the implementation Plan in Part A Section 31. In the event an order is rejected for any reason agreed upon by Sprint and Carrier, the associated interval will restart when Carrier resubmits a correct order to Sprint.

Section 3. Billing

3.1 Procedures

3.1.1 Sprint shall comply with various industry, OBF, and other standards referred to throughout this Agreement. Sprint and CLEC will review any changes to industry standards, and Sprint's interpretation of these standards before they are implemented by Sprint. Until industry standards are adopted and implemented, Sprint shall utilize an interim process as determined by Sprint and reviewed by CLEC as part of the Implementation Plan.

3.1.2 Sprint shall bill CLEC for each service supplied by Sprint to CLEC pursuant to this Agreement at the rates set forth in this Agreement.

3.1.3 Sprint shall provide to CLEC a single point of contact for interconnection and Network Elements at Sprint's National Access Service Center (NASC), and for resale at Sprint's IPOC to handle any Connectivity Billing questions or problems that may arise during the implementation and performance of the terms and conditions of this Agreement.

3.1.4 Sprint shall provide a single point of contact at each Sprint data center for handling of any data exchange questions or problems that may arise during the implementation and performance of the terms and conditions of this Agreement.

3.1.5 Subject to the terms of this Agreement, including without limitation Sections 3.1.6 of this Attachment VIII, CLEC shall pay Sprint within thirty (30) days from the Bill Date. If the payment due date is a Saturday, Sunday or a has been designated a bank holiday payment shall be made the next business day.

3.1.6 Billed amounts which are being investigated, queried, or for which claims have or may be filed shall be handled in accordance with the procedures set forth in Part A Section 22 of this Agreement.

3.1.7 Sprint will assess late payment charges to CLEC in accordance with the applicable tariff or, if there is no tariff Sprint will assess a late payment charge equal to the lesser of one and one-half percent (1 1/2%) or the maximum rate allowed by law per month of the balance due, until the amount due, including late payment charges, is paid in full.

3.1.8 Sprint shall credit CLEC for incorrect Connectivity Billing charges including without limitation: overcharges, services ordered or requested but not delivered, interrupted services, services of poor quality and installation problems if caused by Sprint. Such reimbursements shall be set forth in the appropriate section of the Connectivity Bill pursuant to CABS, or SECAB

3.1.9 The parties agree to record call information for interconnection in accordance with this Subsection 3.1. To the extent technically feasible, each party shall record all call detail information associated with every call originated or terminated to the other party's local exchange subscriber. Sprint shall record for CLEC the messages that Sprint records for its end users. These records shall be provided at a party's request and shall be formatted pursuant to Bellcore's EMR standards and the terms and conditions of this Agreement. These records shall be transmitted to the other party on non-holiday business days in EMR format via CDN. Sprint and CLEC agree that they shall retain, at each party's sole expense, copies of all EMR records transmitted to the other party for at least forty five (45) calendar days after transmission to the other party.

3.1.10 Sprint shall be responsible for billing and collecting charges from IXCs for access related to interexchange calls generated by resale subscribers.

3.1.11 Sprint shall establish a switched access meet point billing arrangement with CLEC. This arrangement will include Tandem routed IXC calls and IXC calls.

3.1.11.1 CLEC will bill for CLEC common line, local switching, RIC, and its portion of the transport charges for Tandem routed IXC calls.

3.1.11.2 SPRINT and CLEC will provide all necessary switched access records to each other for access billing.

3.2 Revenue Protection

3.2.1 Sprint shall make available to CLEC, at Parity with what Sprint provides to itself, its Affiliates and other local telecommunications CLECs, all present and future fraud prevention or revenue protection features, including prevention, detection, or control functionality embedded within any of the Network Elements. These features include, but are not limited to screening codes, information digits assigned such as information digits '29' and '70'

which indicate prison and COCOT pay phone originating line types respectively, call blocking of domestic, international, 800, 888, 900, NPA-976, 700, 500 and specific line numbers, and the capability to require end-user entry of an authorization code for dial tone. Sprint shall, when technically capable and consistent with the implementation schedule for OSS, additionally provide partitioned access to fraud prevention, detection and control functionality within pertinent Operations Support Systems ("OSS").

Section 4. Provision Of Subscriber Usage Data

This Section 4 sets forth the terms and conditions for Sprint's provision of Recorded Usage Data (as defined in this Attachment VIII) to CLEC and for information exchange regarding long distance billing.

4.1 Procedures

4.1.1 General

4.1.1.1 Sprint shall comply with various industry and OBF standards referred to throughout this Agreement.

4.1.1.2 Sprint shall comply with OBF standards when recording and transmitting Usage Data.

4.1.1.3 Sprint shall record all usage originating from CLEC subscribers using service ordered by CLEC, where Sprint records those same services for Sprint subscribers. Recorded Usage Data includes, but is not limited to, the following categories of information:

- Use of CLASS/LASS/Custom Features that Sprint records and bills for its subscribers on a per usage basis
- Calls To Information Providers Reached Via Sprint Facilities will be provided in accordance with Section 4.1.1.7
- Calls To Directory Assistance Where Sprint Provides Such Service To An CLEC Subscriber
- Calls Completed Via Sprint-Provided Operator Services Where Sprint Provides Such Service To CLEC's Local Service Subscriber and where Sprint records such usage

for its subscribers using Industry Standard Bellcore EMR billing records.

- For Sprint-Provided Centrex Service, Station Level Detail

4.1.1.4 Retention of Records: Sprint shall maintain a machine readable back-up copy of the message detail provided to CLEC for a minimum of forty-five (45) calendar days. During the 45 day period, Sprint shall provide any data back-up to CLEC upon the request of CLEC. If the 45 day has expired, Sprint may provide the data back-up at CLEC's expense.

4.1.1.5 Sprint shall provide to CLEC Recorded Usage Data for CLEC subscribers. Sprint shall not submit other CLEC local usage data as part of the CLEC Recorded Usage Data.

4.1.1.6 Sprint shall not bill directly to CLEC subscribers any recurring or non-recurring charges for CLEC's services to the subscriber except where explicitly permitted to do so within a written agreement between Sprint and CLEC.

4.1.1.7 Sprint will record 976/N11 calls and transmit them to the Information Service Provider ("ISP") for billing. Sprint will not bill these calls to either the CLEC or the CLEC's end user.

4.1.1.8 Sprint shall provide Recorded Usage Data to CLEC billing locations as agreed to by the Parties.

4.1.1.9 Sprint shall establish a Local Carrier Service Center (LCSC) or similar function to serve as CLEC's single point of contact to respond to CLEC call usage, data error, and record transmission inquiries.

4.1.1.10 Sprint shall provide CLEC with a single point of contact and remote identifiers (IDs) for each sending location.

4.1.1.11 CLEC shall provide a single point of contact responsible for receiving usage transmitted by Sprint and

receiving usage tapes from a courier service in the event of a facility outage.

4.1.1.12 Sprint shall bill and CLEC shall pay the charges for Recorded Usage Data. Billing and payment shall be in accordance with the applicable terms and conditions set forth in the Connectivity Billing and Recording Section of this Attachment VIII.

4.1.2 Charges

4.1.2.1 Sprint shall bill for message provisioning, data transmission and for data tape charges.

4.1.3 Central Clearinghouse & Settlement

4.1.3.1 Sprint and CLEC shall agree upon Clearinghouse and Incollect/Outcollect procedures.

4.1.3.2 Sprint shall settle with CLEC for both intra-region and inter-region billing exchanges of calling card, bill-to-third party, and collect calls under separately negotiated settlement arrangements.

4.1.4 Lost Data

4.1.4.1 Loss of Recorded Usage Data - CLEC Recorded Usage Data determined to have been lost, damaged or destroyed as a result of an error or omission by Sprint in its performance of the recording function shall be recovered by Sprint at no charge to CLEC. In the event the data cannot be recovered by Sprint, Sprint shall estimate the messages and associated revenue, with assistance from CLEC, based upon the method described below. This method shall be applied on a consistent basis, subject to modifications agreed to by Sprint and CLEC. This estimate shall be used to adjust amounts CLEC owes Sprint for services Sprint provides in conjunction with the provision of Recorded Usage Data.

4.1.4.2 Partial Loss - Sprint shall review its daily controls to determine if data has been lost. When there has been a partial loss, actual message and minute volumes shall be reported, if possible through recovery as discussed in 4.1.4.1 above. Where actual data are not available, a full

day shall be estimated for the recording entity, as outlined in the following paragraphs. The amount of the partial loss is then determined by subtracting the data actually recorded for such day from the estimated total for such day.

4.1.4.3 Complete Loss - When Sprint is unable to recover data as discussed in 4.1.4.1 above estimated message and minute volumes for each loss consisting of an entire AMA tape or entire data volume due to its loss prior to or during processing, lost after receipt, degaussed before processing, receipt of a blank or unreadable tape, or lost for other causes, shall be reported.

4.1.4.4 Estimated Volumes - From message and minute volume reports for the entity experiencing the loss, Sprint shall secure message/minute counts for the four (4) corresponding days of the weeks preceding that in which the loss occurred and compute an average of these volumes. Sprint shall apply the appropriate average revenue per message ("arpm") agreed to by CLEC and Sprint to the estimated message volume for messages for which usage charges apply to the subscriber to arrive at the estimated lost revenue.

4.1.4.5 If the day of loss is not a holiday but one (1) (or more) of the preceding corresponding days is a holiday, use additional preceding weeks in order to procure volumes for two (2) non-holidays in the previous two (2) weeks that correspond to the day of the week that is the day of the loss.

4.1.4.6 If the loss occurs on a weekday that is a holiday (except Christmas and Mother's day), Sprint shall use volumes from the two (2) preceding Sundays.

4.1.4.7 If the loss occurs on Mother's day or Christmas day, Sprint shall use volumes from that day in the preceding year multiplied by a growth factor derived from an average of CLEC's most recent three (3) month message volume growth. If a previous year's message volumes are not available, a settlement shall be negotiated.

4.1.5 Testing, Changes and Controls

4.1.5.1 The Recorded Usage Data, EMR format, content, and transmission process shall be tested as agreed upon by CLEC and Sprint.

4.1.5.2 Periodic Review: Control procedures for all usage transferred between Sprint and CLEC shall require periodic review. This review may be included as part of an Audit of Sprint by CLEC or as part of the normal production interface management function. Breakdowns which impact the flow of usage between Sprint and CLEC must be identified and jointly resolved as they occur. The resolution may include changes to control procedures, so similar problems would be avoided in the future. Any changes to control procedures would need to be mutually agreed upon by CLEC and Sprint.

4.1.5.3 Sprint Software Changes

4.1.5.3.1 When Sprint plans to introduce any software changes which impact the format or content structure of the usage data feed to CLEC, designated Sprint personnel shall notify CLEC no less than ninety (90) calendar days before such changes are implemented.

4.1.5.3.2 Sprint shall communicate the projected changes to CLEC's single point of contact so that potential impacts on CLEC processing can be determined.

4.1.5.3.3 CLEC personnel shall review the impact of the change on the entire control structure. CLEC shall negotiate any perceived problems with Sprint and shall arrange to have the data tested utilizing the modified software if required.

4.1.5.3.4 If it is necessary for Sprint to request changes in the schedule, content or format of usage data transmitted to CLEC, Sprint shall notify CLEC.

4.1.5.4 CLEC Requested Changes

4.1.5.4.1 CLEC may submit a purchase order to negotiate and pay for changes in the content and format of the usage data transmitted by Sprint.

4.1.5.4.2 When the negotiated changes are to be implemented, CLEC and/or Sprint shall arrange for testing of the modified data.

4.2 Information Exchange and Interfaces

4.2.1 Product/Service Specific

4.2.1.1 Sprint shall provide a Bellcore standard 42-50-01 miscellaneous charge record to support the Special Features Star Services if these features are part of Sprint's offering and are provided for Sprint's subscribers on a per usage basis.

4.2.2 Rejected Recorded Usage Data

4.2.2.1 Upon agreement between CLEC and Sprint messages that cannot be rated and/or billed by CLEC may be returned to Sprint via CDN. Returned messages shall be sent directly to Sprint in their original EMR format. Standard EMR return codes shall be utilized.

4.2.2.2 Sprint may correct and resubmit to CLEC any messages returned to Sprint. Sprint will not be liable for any records determined by Sprint to be billable to a CLEC end user. CLEC will not return a message that has been corrected and resubmitted by Sprint. Sprint will only assume liability for errors and unguideables caused by Sprint.

Section 5. General Network Requirements

5.1 Sprint shall provide repair, maintenance and testing for all Telecommunications Services and unbundled Network Elements in accordance with the terms and conditions of this Agreement.

5.1.1 During the term of this Agreement, Sprint shall provide necessary maintenance business process support as well as those

technical and systems interfaces at Parity. Sprint shall provide CLEC with maintenance support at Parity.

5.1.2 Sprint shall provide, initially on a regional basis, and subsequently on a national basis, a SPOC (Single Point of Contact) for CLEC to report via telephone maintenance issues and trouble reports twenty four (24) hours a day and seven (7) days a week.

5.1.3 Sprint shall provide CLEC maintenance dispatch personnel on the same schedule that it provides its own subscribers.

5.1.4 Sprint shall cooperate with CLEC to meet maintenance standards for all Telecommunications Services and unbundled network elements ordered under this Agreement. Such maintenance standards shall include, without limitation, standards for testing, network management, call gapping, and notification of upgrades as they become available.

5.1.5 All Sprint employees or contractors who perform repair service for CLEC subscribers shall follow Sprint standard procedures in all their communications with CLEC subscribers. These procedures and protocols shall ensure that: (1) Sprint employees or contractors shall perform repair service that is equal in quality to that provided to Sprint subscribers; (2) trouble calls from CLEC subscribers shall receive response time priority that is equal to that of Sprint subscribers and shall be handled on a "first come first served" basis regardless of whether the subscriber is a CLEC subscriber or an Sprint subscriber.

5.1.6 Sprint shall provide CLEC with scheduled maintenance, including, without limitation, required and recommended maintenance intervals and procedures, for all Telecommunications Services and network elements provided to CLEC under this Agreement equal in quality to that currently provided by Sprint in the maintenance of its own network.

5.1.7 Sprint shall give maximum advanced notice to CLEC of all non-scheduled maintenance or other planned network activities to be performed by Sprint on any network element, including, without limitation, any hardware, equipment, software, or system, providing service functionality which may potentially impact CLEC subscribers.

5.1.8 For purposes of this subsection 5.1 an emergency network outage is defined as an outage affecting more than 25% of subscriber facilities in a single exchange.

5.1.9 On all misdirected calls from CLEC subscribers requesting repair, Sprint shall provide such CLEC subscriber with the correct CLEC repair telephone number as such number is provided to Sprint by CLEC.

5.1.10 Upon establishment of an Electronic Interface, Sprint shall notify CLEC via such electronic interface upon completion of trouble report. The report shall not be considered closed until such notification is made. CLEC will contact its subscriber to determine if repairs were completed and confirm the trouble no longer exists.

5.1.11 Sprint and CLEC may mutually agree to performance reporting as business needs demand.

5.1.12 Once the electronic gateway is established between Sprint and CLEC, Sprint agrees that CLEC may report troubles directly to a single Sprint repair/maintenance center for both residential and business subscribers, unless otherwise agreed to by CLEC.

5.1.13 Sprint shall perform all testing for resold Telecommunications Services.

5.1.14 Sprint shall provide test results to CLEC, if appropriate, for trouble clearance. In all instances, Sprint shall provide CLEC with the disposition of the trouble.

5.1.15 If Sprint initiates trouble handling procedures, it will bear all costs associated with that activity. If CLEC requests the trouble dispatch, then CLEC's subscriber will bear the cost.

5.1.16 Sprint shall make reasonable efforts to inform CLEC of repair completion and trouble reason as soon as practicable. Notification should be provided via telephone until an electronic interface is available.

5.1.8 For purposes of this subsection 5.1 an emergency network outage is defined as an outage affecting more than 25% of subscriber facilities in a single exchange.

5.1.9 On all misdirected calls from CLEC subscribers requesting repair, Sprint shall provide such CLEC subscriber with the correct CLEC repair telephone number as such number is provided to Sprint by CLEC.

5.1.10 Upon establishment of an Electronic Interface, Sprint shall notify CLEC via such electronic interface upon completion of trouble report. The report shall not be considered closed until such notification is made. CLEC will contact its subscriber to determine if repairs were completed and confirm the trouble no longer exists.

5.1.11 Sprint and CLEC may mutually agree to performance reporting as business needs demand.

5.1.12 Once the electronic gateway is established between Sprint and CLEC, Sprint agrees that CLEC may report troubles directly to a single Sprint repair/maintenance center for both residential and business subscribers, unless otherwise agreed to by CLEC.

5.1.13 Sprint shall perform all testing for resold Telecommunications Services.

5.1.14 Sprint shall provide test results to CLEC, if appropriate, for trouble clearance. In all instances, Sprint shall provide CLEC with the disposition of the trouble.

5.1.15 If Sprint initiates trouble handling procedures, it will bear all costs associated with that activity. If CLEC requests the trouble dispatch, then CLEC's subscriber will bear the cost.

5.1.16 Sprint shall make reasonable efforts to inform CLEC of repair completion and trouble reason as soon as practicable. Notification should be provided via telephone until an electronic interface is available.

5.1.17 Sprint and CLEC shall mutually develop escalation procedures to be followed if, in CLEC's judgment, any performance standard defined in this Agreement is not met for any individual trouble report. The escalation procedures will be provided in the implementation plan and shall include titles and telephone numbers of Sprint management personnel who are responsible for maintenance issues and who will be contacted when a trouble condition is escalated.

5.1.18 Sprint will track repeat trouble reports from the same subscriber in the same manner it tracks repeat trouble reports from its own customers. In the event this report indicates repeat trouble from the same subscriber, other reports or information disclose multiple trouble reports of a similar nature from a different subscribers, or Sprint's service fails to meet specified performance and service quality standards, CLEC may request that Sprint perform a root cause analysis to determine the root cause of the repeat trouble reports, multiple trouble reports or failure to meet standards. If requested by Sprint, CLEC shall provide input or participate in the root cause analysis. Sprint shall report the results of the root cause analysis to CLEC and implement corrections to the root cause(s) revealed by the analysis. CLEC agrees to implement corrections in its processes or procedures revealed by the root cause analysis.

5.1.19 CLEC can report trouble to Sprint twenty-four hours a day, seven days a week using the methods described in the Implementation Plan. Dispatching of Sprint technicians to CLEC subscriber premises shall be accomplished by Sprint pursuant to a request received from CLEC in the manner described in the Sprint/CLEC Trouble Report Clearing Schedule found in the Implementation Plan. For repeat trouble reports, CLEC shall have the ability to escalate repair service requests. This is the same methodology used by Sprint to process troubles from its customers.

5.1.20 Sprint shall flag a trouble report as a repeat trouble if a prior trouble report was closed without repairs being performed to the subscriber's satisfaction. For repeat trouble reports, CLEC shall have the ability to escalate repair service requests.

5.1.21 If systems interfaces are temporarily out of service or not yet in place, Sprint shall provide to CLEC the ability to obtain the status on open maintenance trouble reports via telephone or by another interface as mutually agreed by the Parties.

5.2 Sprint agrees to provide a repair commit time on all residences and business trouble reports.

5.2.1 In the event the "estimated time to restore" has been missed; Sprint shall use reasonable efforts to notify CLEC promptly.

5.2.2 Line outages shall consist of the following categories:

ESL = Essential Line Service (Out-of-Service)

BUS = Business Line (Out-of-Service)

RES = Residence Line (Out-of-Service)

NOOS = All Other Line (Not-Out-of-Service)

Restoration of service shall be provided in accordance with the intervals listed in the Sprint/CLEC Trouble Report Clearing Schedule found in the Implementation Plan.

As intervals change, Sprint will notify CLEC via Facsimile with an update to the Sprint/CLEC Trouble Report Clearing Schedule.

Section 6. Miscellaneous Services and Functions

6.0 General

6.0.1 To the extent that Sprint does not provide the services described in this Section 6 to itself, Sprint will use reasonable efforts to facilitate the acquisition of such services for or by CLEC through the existing service provider. CLEC must contract directly with the service provider for such services.

6.1 General Requirements

6.1.1 Basic 911 and E911 General Requirements

6.1.1.1 Basic 911 and E911 provides a caller access to the appropriate emergency service bureau by dialing a 3-digit universal telephone number (911). Basic 911 and E911 access from Local Switching shall be provided to CLEC in accordance with the following:

6.1.1.2 E911 shall provide additional routing flexibility for 911 calls. E911 shall use subscriber data, contained in the Automatic Location Identification/ Data Management System (ALI/DMS), to determine to which Public Safety Answering Point (PSAP) to route the call.

6.1.1.3 If available, Sprint shall offer a third type of 911 service, S911. All requirements for E911 also apply to S911 with the exception of the type of signaling used on the interconnection trunks from the local switch to the S911 Tandem.

6.1.1.4 Basic 911 and E911 functions provided to CLEC shall be at Parity with the support and services that Sprint provides to its subscribers for such similar functionality.

6.1.1.5 Basic 911 and E911 access when CLEC purchases Local Switching shall be provided to CLEC in accordance with the following:

6.1.1.5.1 Sprint shall conform to all state regulations concerning emergency services.

6.1.1.5.2 For E911, Sprint shall use its service order process to update and maintain subscriber information in the ALI/DMS database. Through this process, Sprint shall provide and validate CLEC subscriber information resident or entered into the ALI/DMS database.

6.1.1.6 Sprint shall provide for overflow 911 traffic to be routed to Sprint Operator Services or, at CLEC's discretion, directly to CLEC operator services.

6.1.1.7 Basic 911 and E911 access from the CLEC local switch shall be provided to CLEC in accordance with the following:

6.1.1.7.1 If required by CLEC, Sprint shall interconnect direct trunks from the CLEC network to the E911 PSAP, or the E911 Tandems as designated by CLEC. Such trunks may alternatively be provided by CLEC.

6.1.1.7.2 In government jurisdictions where Sprint has obligations under existing agreements as the primary provider of the 911 System to the county ("Host SPRINT"), CLEC shall participate in the provision of the 911 System as follows:

6.1.1.7.2.1 Each party shall be responsible for those portions of the 911 System, for which it has control, including any necessary maintenance to each party's portion of the 911 System.

6.1.1.7.2.2 Host SPRINT shall be responsible for maintaining the E-911 database. Sprint shall be responsible for maintaining the E-911 routing database.

6.1.1.7.3 If a third party, is the primary service provider to a government agency, CLEC shall negotiate separately with such third party with regard to the provision of 911 service to the agency. All relations between such third party and CLEC are totally separate from this Agreement and Sprint makes no representations on behalf of the third party.

6.1.1.7.4 If CLEC or its Affiliate is the primary service provider to a government agency, CLEC and Sprint shall negotiate the specific provisions necessary for providing 911 service to the agency and shall include such provisions in an amendment to this Agreement.

6.1.1.7.5 Interconnection and database access shall be priced as specified in Table 1 or at any rate charged to other interconnected CLECs, whichever is lower.

6.1.1.7.6 Sprint shall comply with established, competitively neutral intervals for installation of facilities, including any collocation facilities, diversity requirements, etc.

6.1.1.7.7 In a resale situation, where it may be appropriate for Sprint to update the ALI database, Sprint shall update such database with CLEC data in an interval at Parity with that experienced by Sprint subscribers, or other CLECs, whichever is faster, at no additional cost.

6.1.1.8 Sprint shall transmit to CLEC daily all changes, alterations, modifications, and updates to the emergency public agency telephone numbers linked to all NPA NXX's. This transmission shall be electronic and be a separate feed from the subscriber listing feed.

6.1.1.9 Sprint shall provide to CLEC the necessary Network Elements in order for CLEC to provide E911/911 services to government agencies. If such elements are not available from Sprint, Sprint shall offer E911/911 service for resale by CLEC to government agencies.

6.1.1.10 The following are Basic 911 and E911 Database Requirements:

6.1.1.10.1 The ALI database shall be managed by Sprint, but is the property of Sprint and any participating telephone company and SPRINT for those records provided by the company.

6.1.1.10.2 To the extent allowed by the governmental agency, and where available, copies of the MSAG shall be provided within three business days from the time requested and provided on diskette, magnetic tape, or in a format suitable for use with desktop computers.

6.1.1.10.3 CLEC shall be solely responsible for providing CLEC database records to Sprint for inclusion in Sprint's ALI database on a timely basis.

6.1.1.10.4 Sprint and CLEC shall arrange for the automated input and periodic updating of the E911 database information related to CLEC end users. Sprint shall work cooperatively with CLEC to ensure the accuracy of the data transfer by verifying it against the Master Street Address Guide (MSAG). Sprint shall accept electronically transmitted files or magnetic tape that conform to National Emergency Number Association (NENA) Version #2 format.

6.1.1.10.5 CLEC shall assign an E911 database coordinator charged with the responsibility of forwarding CLEC end user ALI record information to Sprint or via a third-party entity, charged with the responsibility of ALI record transfer. CLEC assumes all responsibility for the accuracy of the data that CLEC provides to Sprint.

6.1.1.10.6 CLEC shall provide information on new subscribers to Sprint within one (1) business day of the order completion. Sprint shall update the database within two (2) business days of receiving the data from CLEC. If Sprint detects an error in the CLEC provided data, the data shall be returned to CLEC within two (2) business days from when it was provided to Sprint. CLEC shall respond to requests from Sprint to make corrections to database record errors by uploading corrected records within two (2) business days. Manual entry shall be allowed only in the event that the system is not functioning properly.

6.1.1.10.7 Sprint agrees to treat all data on CLEC subscribers provided under this Agreement as strictly confidential and to use data on CLEC subscribers only for the purpose of providing E911 services.

6.1.1.10.8 Sprint shall adopt use of a CLEC Code (NENA standard five-character field) on all ALI records received from CLEC. The CLEC Code will be used to identify the CLEC of record in INP configurations. The NENA CLEC Code for CLEC is "CLEC".

6.1.1.10.9 Sprint shall identify which ALI databases cover which states, counties or parts thereof, and identify and communicate a Point of Contact for each.

6.1.1.11 The following are basic 911 and E911 Network Requirements:

6.1.1.11.1 Sprint, at CLEC's option, shall provide a minimum of two (2) E911 trunks per Numbering Plan Area (NPA) code, or that quantity which will maintain P.01 transmission grade of service, whichever is the higher grade of service. These trunks will be dedicated to routing 911 calls from CLEC's switch to a Sprint selective router.

6.1.1.11.2 Sprint shall provide the selective routing of E911 calls received from CLEC's switching office. This includes the ability to receive the ANI of CLEC's subscriber, selectively route the call to the appropriate PSAP, and forward the subscriber's ANI to the PSAP. Sprint shall provide CLEC with the appropriate CLLI codes and specifications regarding the Tandem serving area associated addresses and meet-points in the network.

6.1.1.11.3 Copies of Selective Routing Boundary Maps shall be available to CLEC. Each map shows the boundary around the outside of the set of exchange areas served by that selective router. The map provides CLEC the information necessary to set up its network to route E911 callers to the correct selective router.

6.1.1.11.4 CLEC shall ensure that its switch provides an eight-digit ANI consisting of an information digit and the seven-digit exchange code. CLEC shall also ensure that its switch provides the line number of the calling station. Where applicable, CLEC shall send a ten-digit ANI to Sprint.

6.1.1.11.5 Each ALI discrepancy report shall be jointly researched by Sprint and CLEC. Corrective action shall be taken immediately by the responsible party.

6.1.1.11.6 Where Sprint controls the 911 network, Sprint should provide CLEC with a detailed written description of, but not limited to, the following information:

6.1.1.11.6.1 Geographic boundaries of the government entities, PSAPs, and exchanges as necessary.

6.1.1.11.6.2 LECs rate centers/exchanges, where "Rate Center" is defined as a geographically specified area used for determining mileage dependent rates in the Public Switched Telephone Network.

6.1.1.11.6.3 Technical specifications for network interface, Technical specifications for database loading and maintenance.

6.1.1.11.7 Sprint shall identify special routing arrangements to complete overflow.

6.1.1.11.8 Sprint shall begin restoration of E911 and/or E911 trunking facilities immediately upon notification of failure or outage. Sprint must provide priority restoration of trunks or networks outages on the same terms/conditions it provides itself and without the imposition of Telecommunications Service Priority (TSP).

6.1.1.11.9 Sprint shall identify any special operator-assisted calling requirements to support 911.

6.1.1.11.10 Trunking shall be arranged to minimize the likelihood of central office isolation due to cable cuts or other equipment failures. There will be an alternate means of transmitting a 911 call to a PSAP in the event of failures.

6.1.1.11.11 Circuits shall have interoffice, loop and CLEC system diversity when such diversity can be achieved using existing facilities. Circuits will be divided as equally as possible across available CLEC systems. Diversity will be maintained or upgraded to utilize the highest level of diversity available in the network.

6.1.1.11.12 Repair service shall begin immediately upon receipt of a report of a malfunction. Repair service includes testing and diagnostic service from a remote location, dispatch of or in-person visit(s) of personnel. Technicians will be dispatched without delay.

6.1.1.11.13 All 911 trunks must be capable of transmitting and receiving Baudot code or ASCII necessary to support the use of Telecommunications Devices for the Deaf (TTY/TDDs).

6.1.1.12 Basic 911 and E911 Additional Requirements

6.1.1.12.1 All CLEC lines that have been ported via INP shall reach the correct PSAP when 911 is dialed. Sprint shall send both the ported number and the CLEC number (if both are received from CLEC). The PSAP attendant shall see both numbers where the PSAP is using a standard ALI display screen and the PSAP extracts both numbers from the data that is sent.

6.1.1.12.2 Sprint shall work with the appropriate government agency to provide CLEC the ten-digit POTS number of each PSAP, which sub-tends each Sprint selective router/911 Tandem to which CLEC is interconnected.

6.1.1.12.3 Sprint shall notify CLEC 48 hours in advance of any scheduled testing or maintenance affecting CLEC 911 service, and provide notification as soon as possible of any unscheduled outage affecting CLEC 911 service.

6.1.1.12.4 CLEC shall be responsible for reporting all errors, defects and malfunctions to Sprint. Sprint shall provide CLEC with the point of contact for reporting errors, defects, and malfunctions in the service and shall also provide escalation contacts.

6.1.1.12.5 CLEC may enter into subcontracts with third parties, including CLEC Affiliates, for the performance of any of CLEC's duties and obligations stated herein.

6.1.1.12.6 Sprint shall provide sufficient planning information regarding anticipated moves to SS7 signaling, for 911 services, for the next 12 months.

6.1.1.12.7 Sprint shall provide notification of any impacts to the 911 services provided by Sprint to CLEC resulting from of any pending Tandem moves, NPA splits, or scheduled maintenance outages, with enough time to react.

6.1.1.12.8 Sprint shall identify process for handling of "reverse ALI" inquiries by public safety entities.

6.1.1.12.9 Sprint shall establish a process for the management of NPA splits by populating the ALI database with the appropriate new NPA codes.

6.1.1.12.10 Sprint must provide the ability for CLEC to update 911 databases with end user information for lines that have been ported via INP or NP.

6.1.2 Directory Assistance Service

6.1.2.1 Sprint shall provide for the routing of directory assistance calls (including but not limited to 411, 555-1212, NPA-555-1212) dialed by CLEC subscribers directly to, at CLEC's option, either (a) the CLEC DA service platform to the extent Sprint's switch can perform this customized routing, or (b) Sprint DA service platform to the extent there is a DA service platform for that serving area.

6.1.2.2 CLEC subscribers shall be provided the capability by Sprint to dial the same telephone numbers for access to CLEC Directory Assistance that Sprint subscribers dial to access Sprint Directory Assistance.

6.1.2.3 Sprint shall provide Directory Assistance functions and services to CLEC for its subscribers as described below until Sprint routes calls to the CLEC Directory Assistance Services platform.

6.1.2.3.1 Sprint agrees to provide CLEC subscribers with the same Directory Assistance

6.1.2.3.2 Sprint shall notify CLEC in advance of any changes or enhancements to its DA service, and shall make available such service enhancements on a non-discriminatory basis to CLEC.

6.1.2.3.3 Sprint shall provide Directory Assistance to CLEC subscribers in accordance with Sprint's internal local operator procedures and standards.

6.1.2.3.4 Sprint shall provide CLEC with the same level of support for the provisioning of Directory Assistance as Sprint provides itself. Quality of service standards shall be measured at the aggregate level in accordance with standards and performance measurements that are at Parity with the standards and/or performance measurements that Sprint uses and/or which are required by law, regulatory agency, or by Sprint's own internal procedures, whichever are the most rigorous.

6.1.2.3.5 Service levels shall comply, at a minimum, with State Regulatory Commission requirements for number of rings to answer, average work time, and disaster recovery options.

6.1.2.3.6 CLEC or its designated representatives may inspect any Sprint owned or sub-contracted office, which provides DA services, upon five- (5) business day's notice to Sprint.

6.1.2.3.7 Directory Assistance services provided by Sprint to CLEC subscribers shall be branded in accordance with Section 11 of Part A of this Agreement.

6.1.2.3.8 Sprint shall provide the following minimum Directory Assistance capabilities to CLEC's subscribers:

6.1.2.3.8.1 A maximum of two subscriber listings and/or addresses or Sprint Parity per CLEC subscriber request.

6.1.2.3.8.2 Telephone number and address to CLEC subscribers upon request, except for non-published/unlisted numbers, in the same states where such information is provided to Sprint subscribers.

6.1.2.3.8.3 Upon CLEC's request, call completion to the requested number for local and intraLATA toll calls shall be sent to the network specified by CLEC where such call completion routing is technically feasible. If fulfillment of such routing request is not technically feasible, Sprint shall promptly notify CLEC if and when such routing becomes technically feasible. Rating and billing responsibility shall be agreed to by CLEC and Sprint.

6.1.2.3.8.4 Populate the Directory Assistance database in the same manner and in the same time frame as for Sprint subscribers.

6.1.2.3.8.5 Any information provided by a Directory Assistance Automatic Response Unit (ARU) shall be repeated the same number of times for CLEC subscribers as for Sprint's subscribers.

6.1.2.4 Sprint shall provide CLEC call detail records in a mutually agreed format and manner.

6.1.3 Operator Services

6.1.3.1 Sprint shall provide for the routing of local operator services calls (including but not limited to 0+, 0-) dialed by CLEC subscribers directly to either the CLEC operator service platform or Sprint operator service platform to the extent Sprint's switch can perform this customized routing, as specified by CLEC.

6.1.3.2 CLEC subscribers shall be provided the capability by Sprint to dial the same telephone numbers to access CLEC operator service that Sprint subscribers dial to access Sprint operator service.

6.1.3.3 Sprint shall provide Operator Services to as described below until, at CLEC's discretion, Sprint routes calls to the CLEC Local Operator Services platform.

6.1.3.3.1 Sprint agrees to provide CLEC subscribers the same Operator Services available to Sprint subscribers. Sprint shall make available its service enhancements on a non-discriminatory basis.

6.1.3.3.2 Operator Services provided to CLEC subscribers shall be branded in accordance with Section 11 of Part A of this Agreement.

6.1.3.3.3 Sprint shall provide the following minimum Operator Service capabilities to CLEC subscribers:

6.1.3.3.3.1 Sprint shall complete 0+ and 0-dialed local calls.

6.1.3.3.3.2 Sprint shall complete 0+ intraLATA toll calls.

6.1.3.3.3.3 Sprint shall complete calls that are billed to a 0+-access calling card.

6.1.3.3.3.4 Sprint shall complete person-to-person calls.

6.1.3.3.3.5 Sprint shall complete collect calls.

6.1.3.3.3.6 Sprint shall provide the capability for callers to bill to a third party and complete such calls.

6.1.3.3.3.7 Sprint shall complete station-to-station calls.

6.1.3.3.3.8 Sprint shall process emergency calls.

6.1.3.3.3.9 Sprint shall process Busy Line Verify and Busy Line Verify and Interrupt requests.

6.1.3.3.3.10 To the extent not prohibited by law or regulation, Sprint shall process emergency call trace.

6.1.3.3.3.11 Sprint shall process operator-assisted directory assistance calls.

6.1.3.3.3.12 Sprint shall provide basic rate quotes, subject to Sprint's operator systems being capable to perform unique rating for CLEC, or Sprint shall route requests to a CLEC designated platform.

6.1.3.3.3.13 Sprint shall process time-and-charges requests, at Parity with Sprint's own service offerings.

6.1.3.3.3.14 Sprint shall route 0- traffic directly to a "live" operator team.

6.1.3.3.3.15 When requested by CLEC, Sprint shall provide instant credit on operator services calls as provided to Sprint subscribers or shall inform CLEC subscribers to call an 800 number for CLEC subscriber service to request a credit. Sprint shall provide one 800 number for business subscribers and another for residential subscribers.

6.1.3.3.3.16 Caller assistance for the disabled shall be provided in the same manner as provided to Sprint subscribers.

6.1.3.3.3.17 When available, Sprint shall provide operator-assisted conference calling.

6.1.3.4 Operator Service shall provide CLEC's local usage rates when providing rate quote and time-and-charges services, and subject to Section 6.1.3.3.3.13 above.

6.1.3.5 Operators Service shall adhere to equal access requirements.

6.1.3.6 Sprint shall exercise the same level of fraud control in providing Operator Service to CLEC that Sprint provides for its own operator service.

6.1.3.7 Sprint shall query for Billed Number Screening restrictions when handling Collect, Third Party, and Calling Card Calls, both for station to station and person to person call types.

6.1.3.8 Sprint shall provide at an aggregate level for the operator service center, service measurements and accounting reports to CLEC at Parity with the service measurements and accounting reports Sprint provides itself or as otherwise mutually agreed by the parties.

6.1.3.9 CLEC or its designated representatives may inspect any Sprint owned or sub-contracted office, which provides Operator Services, upon five (5) business day's notice to Sprint.

6.1.3.10 Sprint shall direct CLEC subscriber account and other similar inquiries to the subscriber service center designated by CLEC.

6.1.3.11 Sprint shall provide call records in accordance with Section 4 of this Attachment VIII.

6.1.3.12 Sprint shall accept and process overflow 911 traffic routed from CLEC to the underlying platform used to provide Operator Service where such overflow is performed by Sprint for its subscribers.

6.1.3.13 Busy Line Verification and Busy Line Verify and Interrupt:

6.1.3.13.1 Sprint shall permit CLEC to connect its Local Operator Service to Sprint's Busy Line Verification and Busy Line Verify and Interrupt ("BLV/BLVI").

6.1.3.13.2 Sprint shall engineer its BLV/BLVI facilities to accommodate the anticipated volume of BLV/BLVI requests during the Busy Hour. CLEC may, from time to

time, provide its anticipated volume of BLV/BLVI requests to Sprint. In those instances when the BLV/BLVI systems and databases become unavailable, Sprint shall promptly inform CLEC.

6.1.3.13.3 Where INP is deployed and when a BLV/BLI request for a ported number is directed to a Sprint operator and the query is not successful (i.e., the request yields an abnormal result), the operator, where possible shall confirm whether the number has been ported and shall direct the request to the appropriate operator.

6.1.4 Directory Assistance and Listings Service Requests

6.1.4.1 These requirements pertain to Sprints DA and Listings Service Request process that enables CLEC to (a) submit CLEC subscriber information for inclusion in Sprint Directory Assistance and Directory Listings databases; (b) submit CLEC subscriber information for inclusion in published directories; and (c) provide CLEC subscriber delivery address information to enable Sprint to fulfill directory distribution obligations.

6.1.4.1.1 Sprint shall accept orders on a real-time basis via electronic interface in accordance with OBF Directory Service Request standards within 3 months of the effective date of this Agreement. In the interim, Sprint shall create a standard format and order process by which CLEC can place an order with a single point of contact within Sprint.

6.1.4.1.2 Sprint will provide to CLEC the following Directory Listing Migration Options, valid under all access methods, including but not limited to, Resale, Unbundled Network Elements and Facilities-Based:

6.1.4.1.2.1 Migrate with no Changes: Retain all white page listings for the subscriber in both DA and DL. Transfer ownership and billing for white page listings to CLEC.

6.1.4.1.2.2 Migrate with Additions: Retain all white page listings for the subscriber in both DA and DL. Incorporate the specified additional listing order. Transfer ownership and billing for the white page listings to CLEC.

6.1.4.1.2.3 Migrate with Deletions: Retain all white page listings for the subscriber in both DA and DL. Delete the specified listings from the listing order. Transfer ownership and billing for the white page listings to CLEC.

6.1.4.1.2.4 To ensure accurate order processing, Sprint or its directory publisher shall provide to CLEC the following information, with updates promptly upon changes:

6.1.4.1.2.4.1 A matrix of NXX to central office

6.1.4.1.2.4.2 Geographical maps if available of Sprint service area

6.1.4.1.2.4.3 A description of calling areas covered by each directory, including but not limited to maps of calling areas and matrices depicting calling privileges within and between calling areas.

6.1.4.1.2.4.4 Listing format rules

6.1.4.1.2.4.5 Listing alphabetizing rules

6.1.4.1.2.4.6 Standard abbreviations acceptable for use in listings and addresses

6.1.4.1.2.4.7 Titles and designations

6.1.4.1.2.4.8 A list of all available directories and their Business Office close dates

6.1.4.1.2.4.9 Yellow page heading codes

6.1.4.1.2.4.10 Directory names and codes, identification of which telephone directories are provided to which subscribers by subscriber address, NPA/NXX, or other criteria

6.1.4.1.2.4.11 Directory product changes

6.1.4.1.3 Based on changes submitted by CLEC, Sprint shall update and maintain directory assistance and directory listing data for CLEC subscribers whom:

6.1.4.1.3.1 Disconnect Service

6.1.4.1.3.2 Change CLEC

6.1.4.1.3.3 Install Service

6.1.4.1.3.4 Change any service that affects DA information

6.1.4.1.3.5 Specify Non-Solicitation

6.1.4.1.3.6 Are Non-Published, Non-Listed, or Listed

6.1.4.1.4 Sprint shall not charge for storage of CLEC subscriber information in the DA and DL systems.

6.1.4.1.5 CLEC shall not charge for storage of Sprint subscriber information in the DA and DL systems.

6.1.5 Directory Listings General Requirements. CLEC acknowledges that many directory functions including but not limited to yellow page listings, enhanced white page listings, information pages, directory proofing, and yellow pages directory distribution are not performed by Sprint but rather are performed by and are under the control of the directory publisher. Sprint shall use reasonable efforts to assist CLEC in obtaining an agreement with the directory publisher that treats CLEC at Parity with the publisher's treatment of Sprint.

6.1.5.1 This Section 6.1.5 pertains to listings requirements published in the *traditional white pages*.

6.1.5.2 Sprint shall include in its master subscriber system database all white pages listing information for CLEC subscribers in Sprint territories where CLEC is providing local telephone exchange services.

6.1.5.3 Sprint agrees to include one basic White pages listing for each CLEC customer located within the geographic scope of its White Page directories, at no additional charge to CLEC. A basic White Pages listing is defined as a customer name, address and either the CLEC assigned number for a customer or the number for which number portability is provided, but not both numbers. Basic White Pages listings of CLEC customers will be interfiled with listings of Sprint and other LEC customers.

6.1.5.4 CLEC agrees to provide CLEC customer listing information, including without limitation directory distribution information, to Sprint, at no charge. Sprint will provide CLEC with the appropriate format for provision of CLEC customer listing information to Sprint. The parties agree to adopt a mutually acceptable electronic format for the provision of such information as soon as practicable. In the event OBF adopts an industry-standard format for the provision of such information, the parties agree to adopt such format.

6.1.5.5 Sprint agrees to provide White Pages database maintenance services to CLEC. CLEC will be charged a Service Order entry fee upon submission of Service Orders into Sprint's Service Order Entry System, which will include compensation for such database maintenance services. Service Order entry fees apply when Service Orders containing directory records are entered into Sprint's Service Order Entry System initially, and when Service Orders are entered in order to process a requested change to directory records.

6.1.5.6 CLEC customer listing information will be used solely for the provision of directory services, including the sale of directory advertising to CLEC customers.

6.1.5.7 In addition to a basic White Pages listing, Sprint will provide, at the rates set forth in Attachment II of this Agreement, tariffed White Pages listings (e.g., additional, alternate, foreign and non-published listings) for CLEC to offer for resale to CLEC's customers.

6.1.5.8 Sprint agrees to provide White Pages distribution services to CLEC customers within Sprint's service territory at no additional charge to CLEC. Sprint represents that the quality, timeliness, and manner of such distribution services will be at Parity with those provided to Sprint and to other CLEC customers.

6.1.5.9 Sprint agrees to include critical contact information pertaining to CLEC in the "Information Pages" of those of its White Pages directories covering markets in which CLEC is providing or plans to commence providing local exchange service during the publication cycle of such directories. Critical contact information includes CLEC's business office number, repair number, billing information number, and any other information required to comply with applicable regulations, but not advertising or purely promotional material. CLEC will not be charged for inclusion of its critical contact information. The format, content and appearance of CLEC's critical contact information will conform to applicable Sprint and/or directory publisher guidelines and will be consistent with the format, content and appearance of critical contact information pertaining to all CLECs in a directory.

6.1.5.10 Sprint will accord CLEC customer listing information the same level of confidentiality that Sprint accords its own proprietary customer listing information. Sprint shall ensure that access to CLEC customer proprietary listing information will be limited solely to those of Sprint and Sprint's directory publisher's employees, agents and contractors that are directly involved in the preparation of listings, the production and distribution of directories, and the sale of directory advertising. Sprint will advise its own employees, agents and contractors and its directory publisher of the existence of this confidentiality obligation and will take appropriate measures to ensure their compliance with this obligation. Notwithstanding any provision herein to the contrary, the furnishing of White Pages proofs to a CLEC that contains customer listings of both Sprint and CLEC will not be deemed a violation of this confidentiality provision.

6.1.5.11 Sprint will not sell or license CLEC's customer listing information to any third parties without CLEC's prior written consent. Upon receipt of such consent, Sprint and CLEC will work cooperatively to address any payments for the sale or license of CLEC customer listing information to third parties. Any payments due to CLEC for its customer listing information will be net of administrative expenses incurred by Sprint in providing such information to third parties. The parties acknowledge that the release of CLEC's customer listing to Sprint's directory publisher will not constitute the sale or license of CLEC's customer listing information causing any payment obligation to arise pursuant to this Subsection 6.1.5.11.

6.1.6 Other Directory Services. Sprint will exercise reasonable efforts to cause its directory publisher to enter into a separate agreement with CLEC which will address other directory services desired by CLEC as described in this Section 6.1.6. Both parties acknowledge that Sprint's directory publisher is not a party to this Agreement and that the provisions contained in this Section 6.1.6 are not binding upon Sprint's directory publisher.

6.1.6.1 Sprint's directory publisher will negotiate with CLEC concerning the provision of a basic Yellow Pages listing to CLEC customers located within the geographic scope of publisher's Yellow Pages directories and distribution of Yellow Pages directories to CLEC customers.

6.1.6.2 Directory advertising will be offered to CLEC customers on a nondiscriminatory basis and subject to the same terms and conditions that such advertising is offered to Sprint and other CLEC customers. Directory advertising will be billed to CLEC customers by directory publisher.

6.1.6.3 Directory publisher will use commercially reasonable efforts to ensure that directory advertising purchased by customers who switch their service to CLEC is maintained without interruption.

6.1.6.4 Information pages, in addition to any information page or portion of an information page containing critical contact information as described above in Section 6.1.5.9 may be purchased from Sprint's directory publisher, subject to applicable directory publisher guidelines and regulatory requirements.

6.1.6.5 Directory publisher maintains full authority as publisher over its publishing policies, standards and practices, including decisions regarding directory coverage area, directory issue period, compilation, headings, covers, design, content or format of directories, and directory advertising sales.

6.1.7 Directory Assistance Data

6.1.7.1 This section refers to the residential, business, and government subscriber records used by Sprint to create and maintain databases for the provision of live or automated operator assisted Directory Assistance.

Directory Assistance Data is information that enables telephone exchange CLECs to swiftly and accurately respond to requests for directory information, including, but not limited to name, address and phone numbers. Under the provisions of the Act and the FCC's Interconnection order, Sprint shall provide unbundled and non-discriminatory access to the residential, business and government subscriber records used by Sprint to create and maintain databases for the provision of live or automated operator assisted Directory Assistance. CLEC may combine this element with any other Network Element for the provision of any Telecommunications Service.

6.1.7.2 Sprint shall provide an initial load of subscriber records via magnetic tape for Sprint, included in its Directory Assistance Database within sixty (60) days of the Effective Date of this Agreement. The NPAs included shall represent the entire Sprint operating region. The initial load shall reflect all data that is current as of one business day prior to the provision date.

6.1.7.3 Sprint shall provide CLEC a complete list of LECs, CLECs, and independent Telcos that provided data to Sprint for its DA database.

6.1.7.4 All directory assistance data shall be provided in a mutually agreed format.

6.1.7.5 On the same schedule that Sprint updates its database Sprint shall provide updates (end user and mass) to the Directory Assistance Database via electronic data transfer. Updates shall be current as of one business day prior to the date provided to CLEC.

6.1.7.6 DA data shall specify whether the subscriber is a residential, business, or government subscriber, to the extent Sprint so marks its own DA database records with such indication. Additionally, data must include all levels of indentation and all levels of information specified in "Directory Assistance Data Information Exchanges and Interfaces" below, to the extent Sprint's data is so formatted.

6.1.7.7 CLEC shall pay to Sprint charges for DA listings and updates that are developed consistent with the Act.

6.1.7.8 Sprint shall provide complete refresh of the DA data upon request by CLEC and at CLEC's expense.

6.1.7.9 CLEC will designate the location to which the data will be provided, and CLEC shall order DA data from Sprint at a state/company level.

6.2 Systems Interfaces and Exchanges

6.2.1 Directory Assistance Data Information Exchanges and Interfaces

6.2.1.1 Subscriber List Information

6.2.1.1.1 Sprint shall provide to CLEC, within sixty (60) days after the Approval Date of this Agreement, or at CLEC's request, all published Subscriber List Information (including such information that resides in Sprint's master subscriber system/accounts master file for the purpose of publishing directories in any format as specified by the Act) via an electronic data transfer medium and in a mutually agreed to format, on the same terms and conditions and at the same rates that the Sprint provides Subscriber List Information to itself or to other third parties. All changes to the Subscriber List Information shall be provided to CLEC pursuant to a mutually agreed format and schedule. Both the initial List and all subsequent Lists shall indicate for each subscriber whether the subscriber is classified as residence or business class of service.

6.2.1.1.2 CLEC shall provide directory listings to Sprint pursuant to the directory listing and delivery requirements in the approved OBF format, at a mutually agreed upon timeframe. Other formats and requirements shall not be used unless mutually agreed to by the parties.

6.2.1.2 This section addresses data format requirements and data inclusion requirements for directory assistance data information exchange between Sprint and CLEC. Sprint shall provide CLEC the following where available:

6.2.1.2.1 List of NPA-NXX's relating to the listing records being provided.

6.2.1.2.2 List of Directory Section names and their associated NPA-NXX's.

6.2.1.2.3 List of Community Names expected to be associated with each of the NPA-NXX's for which listing records shall be provided.

6.2.1.2.4 List of Independent Company names and their associated NPA-NXX's for which their listing data is a part of Sprint's directory database, but Sprint is not to provide the listing data to CLEC under this request.

6.2.1.2.5 Listing volume totals by directory section, NPA, and state.

6.2.1.2.6 Average daily update volume by directory section, NPA, and state.

6.2.1.2.7 Identify any area wide or universal service numbers, which may be listed. Identify the telephone number to be provided to callers outside the servicing area.

6.2.1.2.8 Identify any listing condition(s) unique to Sprint's serving area, which may require special handling in data processing in the directory. Indented Listings (Captions) should be identified and delivered and/or handled as specified.

6.2.1.3 Considerations Relating to an Indented Listing (Caption) Set Requirements

6.2.1.3.1 Use of line numbers, or other methods, to ensure the integrity of the caption set and identify the sequence or placement of a listing record within the caption set. A sufficient range of numbers between listing records is required to allow for the expansion of the caption set. A method is also required to permit the caption header record to be identified, but each level of indent is not required to be recapped; placement of the indent is based on line number. This method does require stringent edits to ensure the integrity of the caption set.

6.2.1.3.2 Use of guideline or recapped data to identify previously established header and sub-header records for placement of data within the caption set. This permits flexibility to easily expand the caption set. This method also requires that, in addition to the caption header record, each level of indent be recapped in order to properly build the caption set.

6.2.1.3.3 CLEC requires listing instruction codes on the service order, which indicate how the set is to appear in the published directory.

6.2.1.4 Data Processing Requirements: Sprint and CLEC shall mutually agree to standards on the following data processing requirements:

6.2.1.4.1 Identify type of tape to be used in sending the test and initial load data. For example, reel or cartridge tapes. Due to the size of an initial load, it would be generally expected to be on tape and the daily update activity via another media, and via a mutually agreed to timeframe, such as NDM.

6.2.1.4.2 Identify tape or dataset label requirements.

6.2.1.4.3 Identify tracking information requirements. For example, use of header and trailer records for tracking date and time, cycle numbers, sending and receiving site codes, volume count for the given tape/dataset. It may also be helpful to have some filler fields for future use.

6.2.1.4.4 Identify dates on which the other party should not expect to receive daily update activity.

6.2.1.4.5 Data should be received in uppercase and lowercase pursuant to OBF standards. An asterisk (*) should be used to advise of the need to apply the reverse capitalization rule. However, if the provider determines to provide the listing data from a database that has already messaged the data and applied the capitalization rules, the asterisk may be omitted.

6.2.1.4.6 Identify information that shall enable CLEC to identify listings within an indented list (caption) set. For example:

6.2.1.4.6.1 When a particular listing has been designated to be filed as the first listing for a given level (0-7) of indent - usually out of alpha sequence.

6.2.1.4.6.2 When an alternate call listing (e.g. if no answer) relates to multiple preceding listings of the same level.

6.2.1.4.7 Identify any other pertinent information needed to properly process the data.

6.2.1.5 Listing Types

LISTED	The listing information is available for all directory requirements.
NON-LISTED	The listing information is available to all directory requirements, but the information does not appear in the published street directory.
NON-PUBLISHED	A directory service may confirm, by name and address, the presence of a listing, but the telephone number is not available. The listing information is not available in either the published directory or directory assistance.

6.2.1.6 Listing Styles

<u>LISTING STYLE</u>	<u>DESCRIPTION</u>
STRAIGHT LINE	All listing information is formatted in a straight line. Data generally consists of Name, Address, Community, and Telephone Number. Additional data may consist of dialing instructions or other general information relating to the listing.
INDENTED LISTING SET - CAPTION SET	Formatted with one listing header record and multiple indented listing records. See detailed description below.

INDENTED LISTING (CAPTION) SET

HEADER RECORD Contains listed name; address and telephone number data fields are blank.

SUB-HEADER RECORD/LISTING May contain name data only. Associated subordinate records are required.

INDENTED NAME LISTING Contains name data, may or may not have address data, and telephone number data.

INDENTED ADDRESS LISTING Contains address and telephone number data; the name data text field is blank.

LEVEL OF INDENT Header record is zero (0), sub-header and indented records range from 1 -6.

6.2.1.7 Data Field Elements

Requirements for Initial Processing and Daily Update Activity:

<u>DATA FIELD</u>	<u>DATA ELEMENT</u>	<u>FIELD LENGTH</u>
ACTION CODE	A = Add I = In D = Delete or O = Out	Required: 1 alpha character
RECORD NUMBER	Sequentially assigned number to each record for a given process (test, initial load, or update activity). Number assignment begins with 00000001 and is incremented by 1 for each record on the file.	Required: 8 digits
NPA	Area code relating to the directory section the record is to be listed.	Required: 3 digits
COMPANY IDENTIFIER	The 4-character company code as defined in Section 8 of the National Exchange CLEC Association, Inc. Tariff.	Required: 4 digits
DIRECTORY SECTION	Name of the directory section where the record is to be listed.	Required: Maximum of 50 alpha characters

LISTING IDENTIFIER	<p>F = Foreign</p> <p>C = Cross-Reference</p> <p>E = Enterprise (WX number requiring operator assistance to connect the call)</p> <p>W = Wide area or universal service</p>	Optional: 1 alpha character
FILE PLACEMENT	<p>B = Business (4)</p> <p>R = Residence (1)</p> <p>G = Government (2)</p> <p>BR = Business & Residence (5)</p> <p>BG = Business & Government (6)</p> <p>BRG = Business, Residence & Government (7)</p>	Required: Maximum of 3 alpha characters
LISTING TYPE	<p>L = Listed</p> <p>N = Non-Listed</p> <p>NP = Non-Published</p>	Required: Maximum of 2 alpha characters
ADVANCE LISTING	<p>AVL = Advance Listing</p> <p>This is used when it is very close to the Business Office close date and the service is not actually established but the subscriber needs to be in the directory. Once the service is established, a <i>second order</i> is placed without the indicator and the listing is established permanently and sent to DA.</p>	Optional: 3 alpha characters
LISTING STYLE	<p>S = Straight line</p> <p>I = Indented listing set</p> <p>CH = Caption Header</p> <p>CS = Caption Sub-header</p> <p>An Indented listing relates to either a caption or Straight Line Under (SLU) set listing.</p>	Required: 2 alpha characters
INDENT LEVEL	<p>0 = Non-indented record</p> <p>1 - 6 = Level of indented record</p>	Required: 1 digit

ADDRESS HOUSE NUMBER	For example: 123, A-123, 123-1/2	Optional: Maximum of 20 alphanumeric characters, including hyphen, space, and slash
ADDRESS PRE- DIRECTIONAL	For example: N, S, E, W, NE, SW, NORTH	Optional: Maximum of 5 alpha characters
ADDRESS STREET NAME	For example: Main, Peachtree- Dunwoody, HWY 75 at Exit 30	Optional: Maximum of 100 alpha, alphanumeric characters, including spaces and hyphens.
ADDRESS SUFFIX OR THOROUGH FARE	For example: SUITE 160, ST, or WAY	Optional: Maximum of 20 numeric, alpha, or alphanumeric characters
ADDRESS POST DIRECTION	For example: N, S, NE, SW	Optional: Maximum of 5 alpha characters
ADDRESS CODE	ZIP 5-digits or ZIP + 4	Optional: Maximum of 10 digits, including the hyphen when using ZIP + 4
COMMUNITY NAME	Identifies the name of the community associated with the listing record. See Glossary for more details.	Maximum of 50 alphanumeric characters, including spaces and hyphen
STATE ABBREVIATION	Identifies the state associated with the community name; 2-character state abbreviation used by the US Postal Office.	Maximum of 2 alpha characters

INFORMATION TEXT	Miscellaneous information relating to the listing. Including, but not limited to, for example: TOLL FREE DIAL 1 & THEN, CALL COLLECT, or TDD ONLY. The various types of Information Text must be identified to CLEC.	Optional: Maximum of 250 alpha, numeric, or alphanumeric characters
NAME - FIRST WORD	Surname of a Residence or Business listing, or first word of a Business or Government listing	Required for a zero (0) level record.
	Multi-word or hyphenated surnames should be treated as one word.	Optional if an indented (level 1-8) record unless the name text present in the indented record relates to a Surname.
NAME - SUBSEQUENT WORD(S)	Given name and/or initial(s) of a Surname listing or Additional word(s) for a Business or Government listing	Maximum of 50 alpha, numeric, alphanumeric, or special characters Expected if the First Word is the Surname of a Residence or Business listing. Maximum of 250 alpha, numeric, special, or alphanumeric characters.
LINEAL DESCENT	E.g. SR, JR, III. If Lineal Descent data cannot be uniquely identified, it should be included with the Listed Name Subsequent Word(s) data and placed at the end of the name data.	Optional: Maximum 10 alpha characters
TITLE(s)	E.g. MRS, LT COL, RET SGR, DR. Multiple titles are acceptable. If title data cannot be uniquely identified, it should be included with the Listed Name Subsequent Word(s) data and placed at the end of the name data stream. If lineal descent is also in the Listed Name Subsequent Word(s) data field, title data should be placed following the lineal descent data.	Optional: Maximum of 20 alpha characters

DEGREE	E.g. MD, CPA, PHD. Multiple degrees are acceptable. If degree data cannot be uniquely identified, it should be included with the Listed Name Subsequent Word(s) data and placed at the end of the name data stream. If lineal descent and/or title data is also present, it should follow title data.	Optional: Maximum of 20 alpha characters
NICKNAME	Another name the listed subscriber may be known by.	Optional: Maximum of 20 alpha characters
BUSINESS DESIGNATION	Term used to identify the listed subscriber's profession, business, or location, e.g. ATTY, CARPETS, OFC	Optional: Maximum of 50 alpha characters
STANDARD TELEPHONE NUMBER *	NPA NXX-LINE	Optional: 12 characters, including space and hyphen
YELLOW PAGE PUBLISHERS ASSOCIATION (YPPA)	CLEC shall provide to Sprint the code for the directory in which the listing is to be placed.	
NON-STANDARD TELEPHONE NUMBER *	Telephone numbers less than or more than the standard telephone number.	Optional: Minimum of 1 digit, maximum of 22 characters, including spaces and hyphens

* Either a Standard or Non-standard telephone is required for a zero level record unless the record is a Cross-Reference listing or an Indented Listing (caption) Set record. A telephone number may, or may not be present on an Indented Listing Set record for level(s) 0-7.

6.3 Systems Security

6.3.1 Sprint agrees to comply with industry accepted standards which in large measure reflect common practices and proven technology for protecting computer resources.

PART C - ATTACHMENT IX

REPORTING STANDARDS

Section 1. General

1.1 Sprint shall satisfy all service standards, intervals, measurements, specifications, performance requirements, technical requirements, and performance standards (Performance Standards) that are specified in this agreement or are required by law or regulation. In addition, Sprint's performance under this Agreement shall be provided to CLEC will be at Parity with the performance Sprint provides itself for like service(s).

1.2 Sprint and CLEC agree that generally remedies at law alone are adequate to compensate CLEC for any failures to meet the Performance Standard requirements specified in this Agreement, or for failures to provide Customer Usage Data in accordance with this Agreement. However, CLEC shall have the right to seek injunctive relief and other equitable remedies to require Sprint (i) to cause the service ordered by CLEC to meet the Performance Standards specified by the Agreement, (ii) install or provision service ordered by CLEC within the Due Dates specified in this Agreement and (iii) to provide Customer Usage Data in accordance with this Agreement.

1.3 Sprint and CLEC agree that all financial remedies available to end-user and access customers for same or like services will be offered to CLEC. At such time that state or federal commission-approved credits/financial remedies are put in place between Sprint and any of its CLEC customers, the Parties shall renegotiate this arrangement where such arrangements exist.

Section 2. Parity and Quality Measurements

2.1 Sprint will develop self-reporting capabilities comparing Sprint results with CLEC results for the following measures of service parity by December 31, 1998:

Percentage of Commitment Times Met - Service Order

Percentage of Commitment Times Met - Trouble Report

Trouble Reports per 100 Access Lines

Trunk Orders on or Before the Committed Due Date

Average Clearing Time - Out of Service

Percent Repeated Trouble Reports

Percent Reporting Trouble Within 5 Days of the Date Installed

In the event CLEC chooses to utilize the Sprint operator service platform and to provision separate trunks into the operator service platform, the following measures will be implemented within 6 months of the date of first use by CLEC:

Average Toll Answer Time

Average Directory Assistance Answer Time

All above measures will be implemented in a manner that is consistent with the current measures Sprint makes of its own performance.

2.2 The Parties agree to adopt additional performance measures as may be required by the FCC or appropriate state commissions and as mutually agreed upon by the Parties.